



# Dominion KX III User Station

User Guide  
Release 1.0.0

---

Copyright © 2015 Raritan, Inc.

KX3UST-0A-v1.0.0-E

November 2015

255-62-0011-00

---

This document contains proprietary information that is protected by copyright. All rights reserved. No part of this document may be photocopied, reproduced, or translated into another language without express prior written consent of Raritan, Inc.

© Copyright 2015 Raritan, Inc. All third-party software and hardware mentioned in this document are registered trademarks or trademarks of and are the property of their respective holders.

#### FCC Information

This equipment has been tested and found to comply with the limits for a Class A digital device, pursuant to Part 15 of the FCC Rules. These limits are designed to provide reasonable protection against harmful interference in a commercial installation. This equipment generates, uses, and can radiate radio frequency energy and if not installed and used in accordance with the instructions, may cause harmful interference to radio communications. Operation of this equipment in a residential environment may cause harmful interference.

#### VCCI Information (Japan)

この装置は、クラスA情報技術装置です。この装置を家庭環境で使用すると電波妨害を引き起こすことがあります。この場合には使用者が適切な対策を講ずるよう要求されることがあります。 VCCI-A

Raritan is not responsible for damage to this product resulting from accident, disaster, misuse, abuse, non-Raritan modification of the product, or other events outside of Raritan's reasonable control or not arising under normal operating conditions.

If a power cable is included with this product, it must be used exclusively for this product.



# Contents

<b>Chapter 1 Introduction</b>	<b>1</b>
<hr/>	
Overview .....	1
Package Contents.....	2
Product Photos and Features .....	2
Product Features .....	2
Product Photos .....	3
Introduction to the User Station .....	4
Front View.....	4
Rear View .....	5
Side View.....	5
Introduction to the Software .....	6
Login Screen.....	6
Main Screen and Main Toolbar .....	8
Online Help and Hot Keys Help.....	10
<b>Chapter 2 Getting Started</b>	<b>11</b>
<hr/>	
Installation and Configuration .....	11
Step 1: Connect the Equipment.....	11
Step 2: Log in to the Dominion User Station .....	12
Step 3: Add KX III KVM Switches.....	13
Step 4: Access KVM Switches and KVM Ports .....	15
Step 5: Use the KVM Client.....	18
Basic Network Settings.....	21
Logout or Shutdown.....	23
VESA Mount (Optional) .....	23
Rackmount Using L-type Brackets (Optional) .....	25
<b>Chapter 3 Managing KVM Switches and Ports</b>	<b>27</b>
<hr/>	
User Station Configuration.....	27
Adding KVM Switches .....	29
Editing KVM Switches.....	30
Deleting KVM Switches .....	31
Configuring KVM Ports .....	31
Invalid Hot Keys for Port Access .....	33
Port Data Retrieval Status .....	34

**Chapter 4 Navigation and Access to KVM Ports 36**

---

Overview .....	37
Port Navigator .....	38
Identifying States of KVM Switches and Ports .....	40
Using Search .....	42
Using Filters .....	43

**Chapter 5 Using the KVM Client 45**

---

Connection Properties .....	46
Default Connection Properties.....	48
Text Readability .....	49
Color Accuracy .....	49
Video Mode.....	49
Noise Filter.....	50
Keyboard/Hot Key Settings.....	50
Mouse Settings .....	51
Synchronize Mouse .....	52
Single Mouse Cursor .....	52
Dual Mouse Modes.....	53
Mouse Synchronization Tips .....	55
Video Settings.....	56
Advanced Video Settings .....	58
Advanced Color Settings.....	60
USB Settings.....	61
USB Profile Overview .....	62
Virtual Media.....	63
Audio.....	69
Power Control .....	70
View Settings .....	71
Fit window to Target .....	71
Scale Video.....	72
Show Window Decorations.....	72
Full Screen Mode .....	72

**Chapter 6 Setting User Preferences 74**

---

Keyboard Macros.....	74
Executing Macros .....	76
Editing or Deleting Macros .....	77
Keyboard Macro Example .....	77

Audio Settings.....	78
KVM Client Settings.....	79
Password Change.....	80

**Chapter 7 Administration Features 81**

---

Users.....	82
Editing or Deleting Users.....	84
User Groups.....	85
Privileges.....	87
Editing or Deleting User Groups.....	87
Backup and Restore.....	89
Exporting and Importing Backup Files.....	90
Deleting Backup Files.....	91
Factory Reset.....	92
Software Update.....	94
Support.....	95
About this Device.....	96

**Chapter 8 System Settings 98**

---

Date/Time.....	99
Date and Time.....	100
Time Zone.....	101
Keyboard.....	102
General.....	103
Layouts.....	104
Accessibility.....	106
Mouse Keys.....	108
Typing Break.....	109
Monitors.....	109
Network Connections.....	111
IPv4 Settings.....	113
IPv6 Settings.....	117
Sound Preferences.....	120
Hardware.....	121
Input.....	122
Output.....	122
Default Shortcut Icons in the Main Toolbar.....	122
Keyboard Layout Icon.....	123
Volume Icon.....	123
Network Icon.....	123
Clock Icon.....	125
Location and Clock Time Format.....	127

Contents

Screen and Keyboard Settings in the Login Screen.....	130
<b>Appendix A Specification</b>	<b>132</b>
<hr/>	
<b>Appendix B Authentication of User Stations and KVM Switches</b>	<b>133</b>
<hr/>	
<b>Appendix C Available Key Sets</b>	<b>135</b>
<hr/>	
<b>Appendix D Hot Keys for Controlling User Station Windows</b>	<b>138</b>
<hr/>	
<b>Index</b>	<b>141</b>
<hr/>	

# Chapter 1 Introduction

This chapter introduces the Dominion KX III User Station.

## In This Chapter

Overview.....	1
Package Contents .....	2
Product Photos and Features.....	2
Introduction to the User Station.....	4
Introduction to the Software.....	6

---

## Overview

The Dominion User Station (DKX3-UST) is designed to access servers and computer devices connected to Dominion KX III KVM switches from customer LAN/WAN networks. ALL KX III KVM switches are supported.

*Note: For information on KX III KVM switches, access its user documentation from its application or the Dominion KX III section of the Raritan website's **Support page** (<http://www.raritan.com/support/>).*

You can store the IP addresses of multiple KX III KVM switches on the Dominion User Station so that you can remotely access any IT device connected to these KVM switches with only one click.

► **Illustration diagram:**

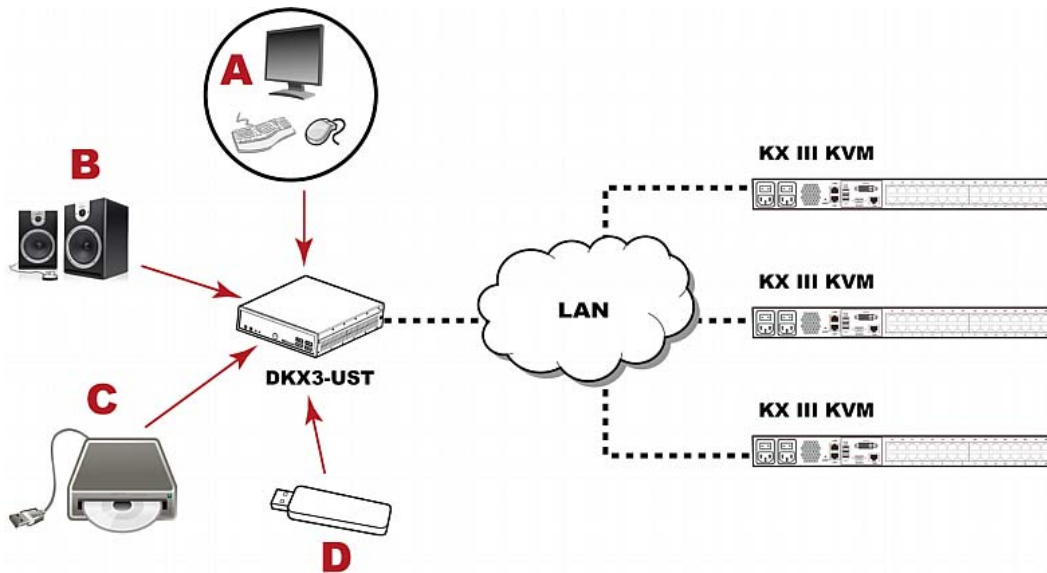

<b>A</b>	A USB Keyboard, USB mouse, and one or two HDMI- or DisplayPort-interfaced monitors
<b>B</b>	Analog or digital audio appliances
<b>C</b>	External drives as virtual media, such as CD-ROM
<b>D</b>	USB drives

---

## Package Contents

The Dominion User Station ships with the following contents.

- Dominion User Station
- Power adapter
- VESA mount kit
- Quick Setup Guide
- Warranty card
- L-type rackmount kit (optional)

---

## Product Photos and Features

---

### Product Features

- Support video resolutions up to 3840 x 2560
- Support a HDMI- or DisplayPort-interfaced monitor
- Support dual monitors
- Support dual LAN connections
- Support virtual media, including external DVD or USB drives

---

*Note: Virtual media is supported only when the accessed KX III KVM switch supports it and you have permissions to use virtual media. See **Virtual Media** (on page 63).*

---

- Support audio
- Support power control for target servers (with Raritan PX PDUs)

---

*Note: The User Station CANNOT access a KVM port that is connected to a KVM switch or a blade chassis server.*

---



---

## Product Photos

### Dominion User Station



### Power adapter and cord



### VESA mount kit



---

## Introduction to the User Station

---

### Front View

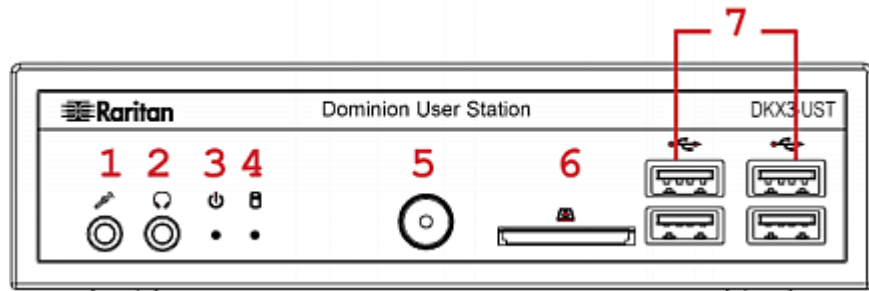

- |                     |                   |
|---------------------|-------------------|
| 1. Microphone input | 5. Power button   |
| 2. Audio output     | 6. SD card reader |
| 3. Power LED        | 7. USB 2.0 ports  |
| 4. Hard disk LED    |                   |

**Rear View**

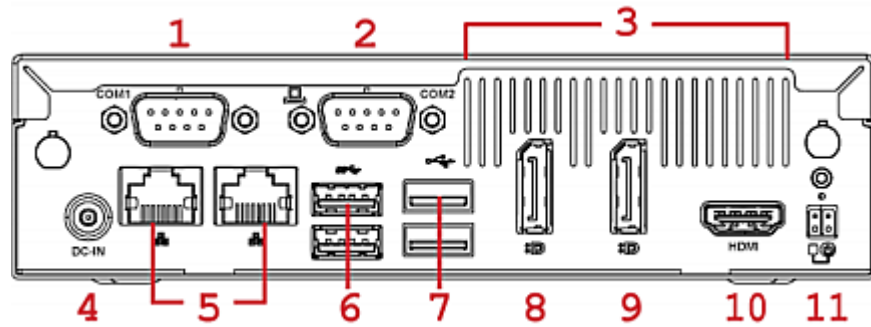

- |                      |                                         |
|----------------------|-----------------------------------------|
| 1. RS232/RS422/RS485 | 7. USB 2.0 ports                        |
| 2. RS232             | 8. DisplayPort (DP) video 1             |
| 3. Ventilation       | 9. DisplayPort (DP) video 2             |
| 4. DC power input    | 10. HDMI video                          |
| 5. Gigabit LAN ports | 11. Connector for external power button |
| 6. USB 3.0 ports     |                                         |

*Note: Both RS232 ports are reserved and cannot be used by the user. The connector for external power button is reserved for future use.*

**Side View**

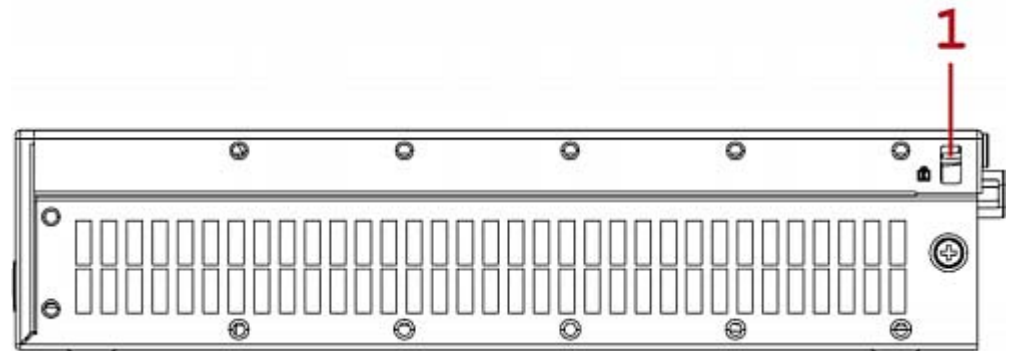

- 1. Kensington Lock holes

---

## Introduction to the Software

After powering on the User Station, the Login Screen is shown.

After successfully logging in to the User Station, the Main Screen displays.

---

### Login Screen

The following diagram illustrates the Login Screen.

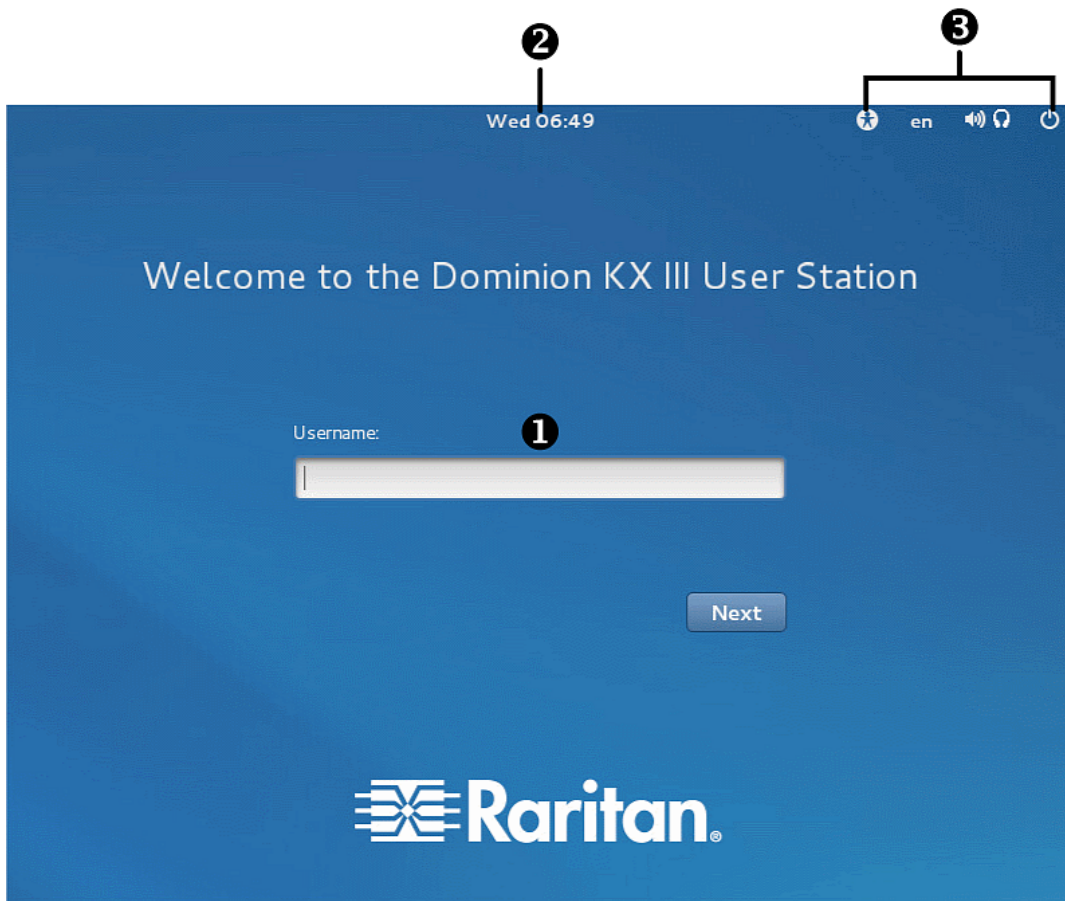

1. **Text box for entering user credentials:**





For initial login, see **Step 2: Log in to the Dominion User Station** (on page 12).

2. **Day of the week and system time:**

To view the current date, click it to show the calendar.

3. **Icons to configure system settings in the Login Screen:**

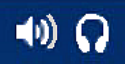
Click the desired icon to configure its settings. These settings apply to the Login Screen only. They do NOT impact the Main Screen, which is shown after login.

Icons	Description
	<p>Turn on or off any of the following functions:</p> <ul style="list-style-type: none"> <li>▪ High Contrast</li> <li>▪ Zoom</li> <li>▪ Large Text</li> <li>▪ Screen Keyboard</li> <li>▪ Visual Alerts</li> <li>▪ Sticky Keys</li> <li>▪ Slow Keys</li> <li>▪ Bounce Keys</li> <li>▪ Mouse Keys</li> </ul> <p>By default, all of these settings are turned OFF. For details, see <b>Screen and Keyboard Settings in the Login Screen</b> (on page 130).</p> <hr/> <p><i>Note: Screen Reader is NOT supported.</i></p>
	<p>Determine the keyboard layout. Default layouts include:</p> <ul style="list-style-type: none"> <li>▪ English (US) - en</li> <li>▪ Spanish - es</li> <li>▪ French - fr</li> <li>▪ German - de</li> </ul>
	<p>Adjust the volume.</p>
	<p>Perform one of power control operations:</p> <ul style="list-style-type: none"> <li>▪ Suspend: Enters the power-saving mode.</li> <li>▪ Restart: Restarts the User Station.</li> <li>▪ Power Off: Powers off the User Station.</li> </ul>

## Main Screen and Main Toolbar

The screen displayed after login is the Main Screen.

The Main Toolbar is located at the bottom of this screen. This toolbar shows the Main Menu, shortcut icons and lists any open User Station and KVM Client windows.

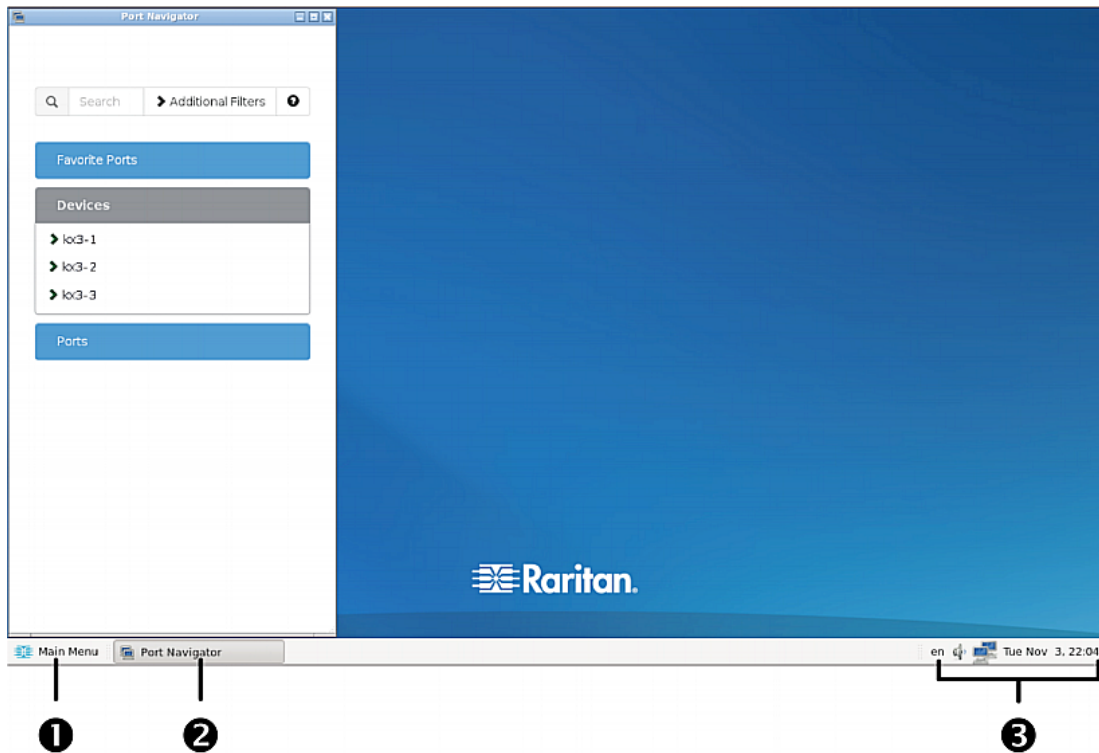

### 1. Main Menu:

This menu contains the primary User Station commands and system settings.

### 2. Open window(s):

If any window is launched, its name is shown in the Main Toolbar. In the above diagram, only the Port Navigator window is launched.

You can right-click any open window in the Main Toolbar to perform one of the following commands:

Command	Description
Minimize	Minimize the window. After a window is minimized, the Minimize command will be replaced by the Unminimize command. Select Unminimize to restore the window.

Command	Description
Maximize	Maximize the window. After a window is maximized, the Maximize command will be replaced by the Unmaximize command. Select Unmaximize to restore the window.
Move	After selecting this command, move your mouse to move the window.
Resize	After selecting this command, move your mouse to resize the window.
Always On Top	When selected, the window is always on top of any open windows.
Close	Close the window.



### 3. Shortcut icons for viewing/configuring system settings:

Hover your mouse pointer over an icon to view information, or click or right-click it to configure settings.

---

*Note: The above diagram shows factory default icons. More icons may be available if you change any system settings. For example, **Monitors** (on page 109).*

---

Default icons	Description
en	The Keyboard Layout icon indicates the current keyboard layout. The default is <i>en</i> (American English). See <b>Keyboard Layout Icon</b> (on page 123).
	This icon controls the volume. See <b>Volume Icon</b> (on page 123).
	This icon shows or configures the network information. See <b>Network Icon</b> (on page 123).
Tue Nov 10, 03:34	The Clock icon indicates the day of the week, date and current time. See <b>Clock Icon</b> (on page 125).

---

### Online Help and Hot Keys Help

Both online help for using the Dominion User Station and information on pre-programmed hot keys are available in the Main Menu.

▶ **Online help:**

- Choose Main Menu > Help > User Manual.

As long as the User Station is connected to the Internet, the User Manual link directs you to the Dominion User Station's online help.

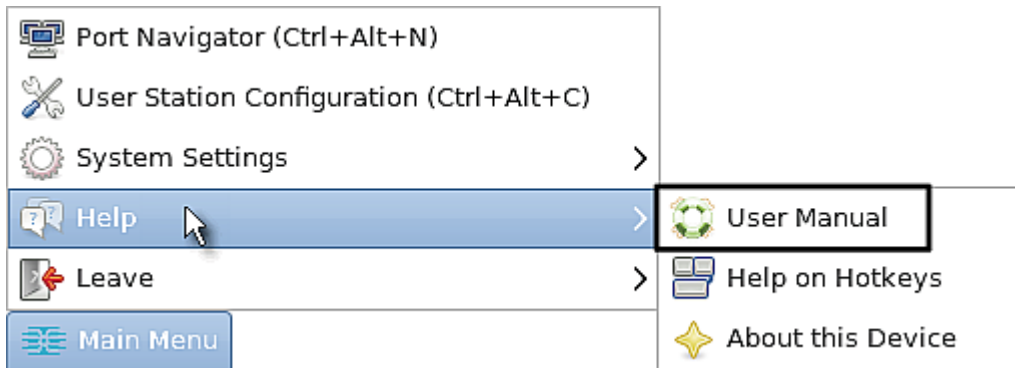

▶ **Information on pre-programmed hot keys:**

- Choose Main Menu > Help > Help on Hotkeys.

A list of pre-programmed as well as user-configurable hot keys for the User Station displays onscreen.

---

*Note: Information of most hot keys is also available in this User Guide. See **Configuring KVM Ports** (on page 31) and **Hot Keys for Controlling User Station Windows** (on page 138).*

---



# Chapter 2 Getting Started

This chapter introduces the basic installation and configuration.

## In This Chapter

Installation and Configuration .....	11
Basic Network Settings.....	21
Logout or Shutdown .....	23
VESA Mount (Optional) .....	23
Rackmount Using L-type Brackets (Optional) .....	25

---

## Installation and Configuration

---

### Step 1: Connect the Equipment

Only the basic hardware installation is described. For additional connection information, see **Overview** (on page 1).

► **To make a basic connection:**

1. Disconnect all devices from power.
2. Connect a USB keyboard and mouse to the front or rear USB 2.0 ports.
3. **Optional.** Connect a microphone and speakers to the front panel.

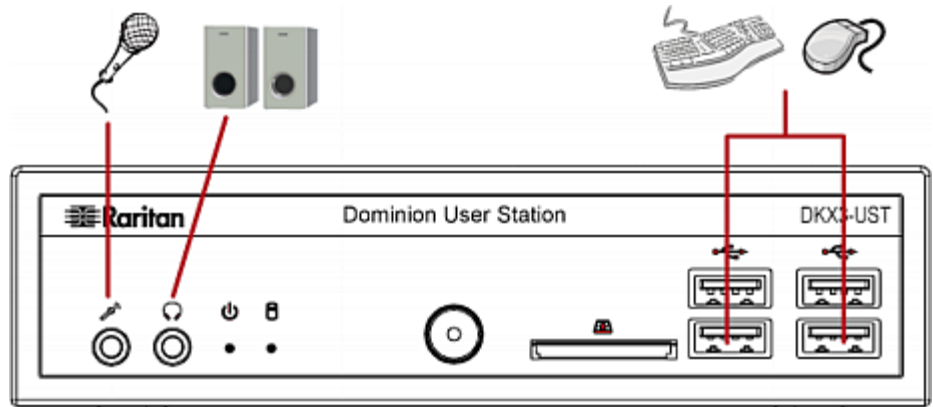

4. Connect the User Station to the network via either or both LAN ports on the rear panel.
5. Connect one or two monitors via either or both DisplayPort ports, or the HDMI port.

---

*Note 1: DisplayPort and HDMI transmit both video and audio signals. Your monitor(s) must support the audio transmission if audio is intended.*

---

*Note 2: Only one or two monitors can be connected to the User Station.*

---

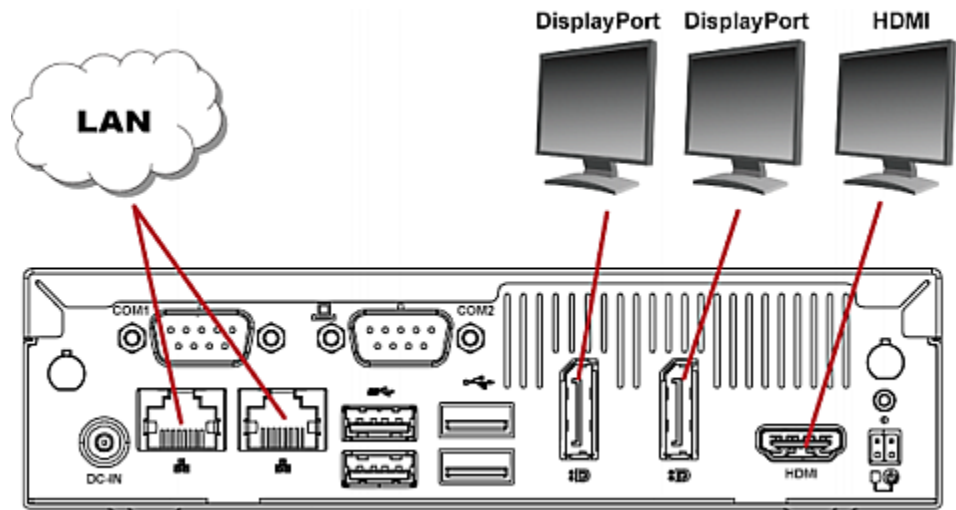

6. Power ON all devices.

---

### Step 2: Log in to the Dominion User Station

Use the factory default user credentials for initial login. User credentials are case sensitive.

► **To log in to the User Station:**

1. Type the username: admin.

The screenshot shows a login interface with a blue background. The label 'Username:' is positioned above a text input field. The input field contains the text 'admin'. To the right of the input field is a blue button with the text 'Next'. A mouse cursor is pointing at the 'Next' button.

2. Type the password: raritan.



A blue dialog box with the title "Password:". It contains a text input field with seven black dots and a vertical cursor. Below the input field are two buttons: "Cancel" on the left and "Sign In" on the right. A mouse cursor is pointing at the "Sign In" button.

*Note: It is strongly recommended to change the factory default password. See **Password Change** (on page 80).*

### Step 3: Add KX III KVM Switches

If the User Station is connected to a non-DHCP network, you must manually configure the network settings prior to adding KX III KVM switches. See **Basic Network Settings** (on page 21).

KX III KVM switches are added in the User Station Configuration window.

#### ► To add KX III KVM switches:

1. Launch the User Station Configuration window using either method below.
  - Press *Ctrl+Alt+C*.
  - Choose Main Menu > User Station Configuration. For the Main Menu's location, see **Main Screen and Main Toolbar** (on page 8).

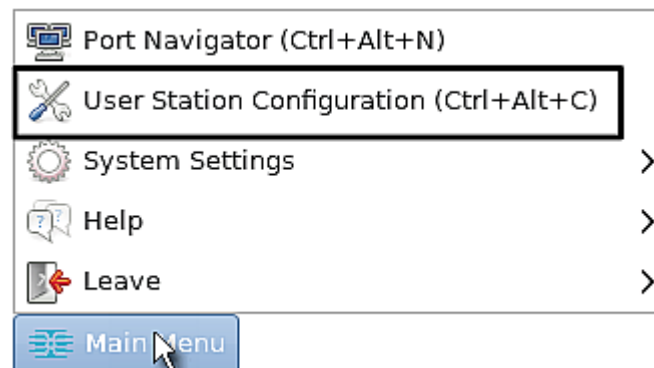

2. Click .
3. Enter the data for the KX III KVM switch.

**\* IP Address / Hostname**

Type the KVM switch's IP address or hostname in this field.

**\* Username**

User credentials on the KVM switch are required for querying this KVM switch's port information.

The user credentials may or may not be the same as your user credentials for the User Station. See ***Authentication of User Stations and KVM Switches*** (on page 133).

**\* Password**

---

*Note: If you enter incorrect user credentials for a KVM switch, and the User Blocking feature has been enabled on that KVM switch, you will be automatically blocked by that KVM switch because the User Station tries accessing it for several times. When this occurs, contact the KVM switch's system administrator for help.*

---

Add KX Device

4. Click **Add KX Device** to save your data.
5. Click Back to return to the KX Devices page. Then repeat the same steps to add more KVM switches.

---

**Important: User credentials for querying a KVM switch's information are saved on a per-user basis. Other users must enter and save their own user credentials again for the KVM switches you added. See *Editing KVM Switches* (on page 30).**

---

---

#### Step 4: Access KVM Switches and KVM Ports

You access the computer devices connected to a KVM switch's ports through the Port Navigator window, which contains 3 panels:

- **Favorite Ports** shows the favorite ports you have configured. See **Configuring KVM Ports** (on page 31).
- **Devices** shows all added KX III KVM switches and their ports.
- **Ports** shows only KVM ports.

This window is displayed by default. If not, launch it by pressing **Ctrl+Alt+N** or choosing Main Menu > Port Navigator.

---

*Note: The User Station CANNOT access a KVM port that is connected to a KVM switch or a blade chassis server. Therefore, such KVM ports are not shown in the Port Navigator window.*

---

#### ► To access a KVM switch's ports:

1. Click a KVM switch in the Devices panel.

---

*Note: If a KVM switch has the Single Login Limitation enabled, the **User Station's port status retrieval program** will consume the single login while the User Station is operating. On that User Station, this KVM switch is taken as a KVM switch with communication errors so it is not displayed by default. See **Port Navigator** (on page 38).*

---

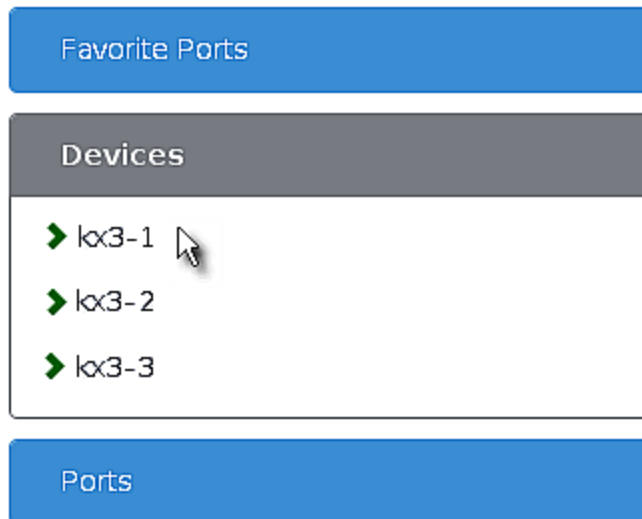



2. Per default, only a list of "up" ports is displayed under the selected KVM switch.
  - Numbers in parentheses are the physical port numbers on the KVM switch.

---

*Note: To show KVM ports whose status is down, see **Using Filters** (on page 43).*

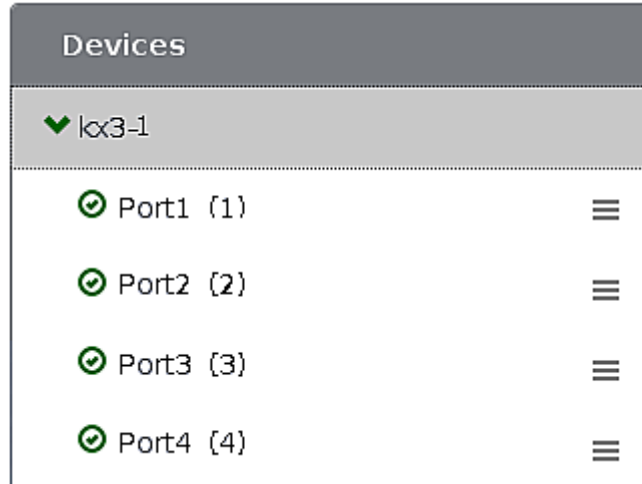
---



3. Click the desired KVM port's icon , and select one option below.
  - *Open in new KVM client:* A new KVM Client window is opened.
  - *Open in current KVM client:* The port is launched into the current KVM Client window.

Another alternative to access the KVM port is to click the port's name, using any method below.

- A "single" click opens it in the current KVM Client window.
- A "double" click opens it in a new KVM Client window.
- A "right" click shows the KVM Client options.

► **To directly access a KVM port:**

1. Click the Ports panel, and all "up" KVM ports are displayed by default.

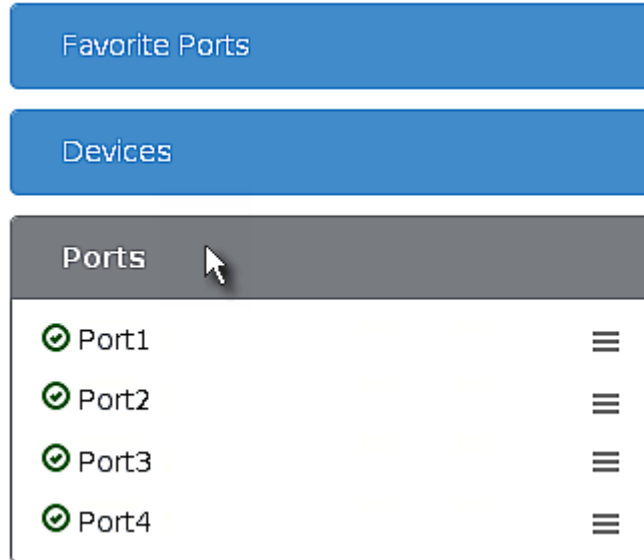

2. Click the desired port's name, or click its icon ☰.

---

### Step 5: Use the KVM Client

The User Station's KVM Client window opens after accessing a KVM port. The video of the target server that is connected to the KVM port is displayed in the KVM Client. You can use the attached keyboard and mouse to control the target server.



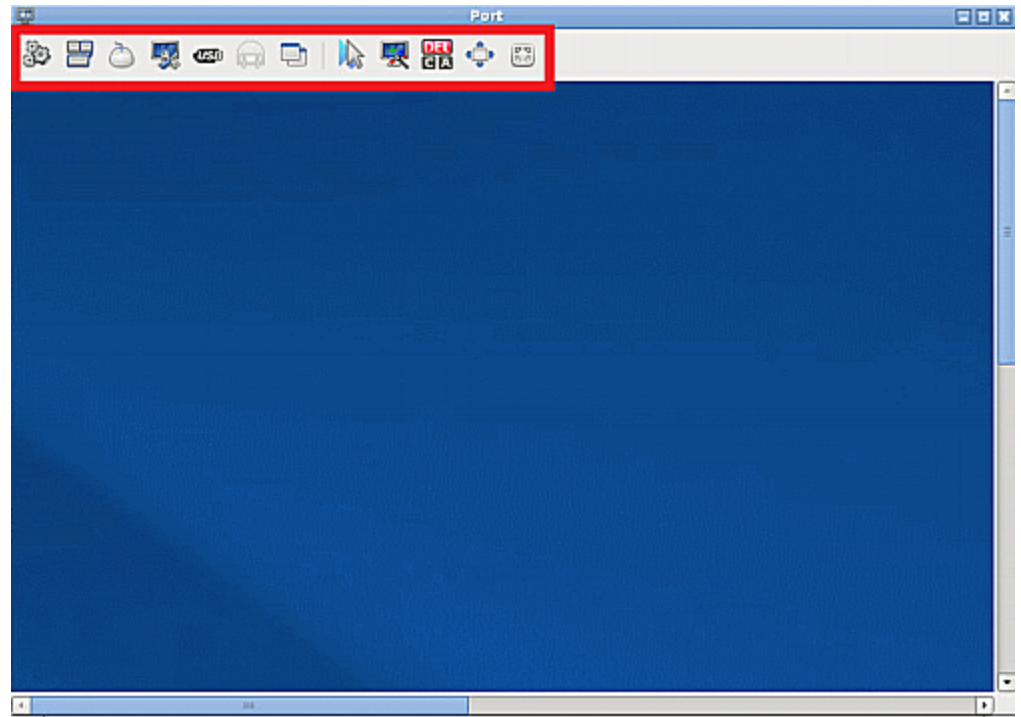



A toolbar is available on the top of the KVM Client window for helpful user operations and settings.











The toolbar is split into two groups with a vertical divider line.

The left group comprises the following buttons that you can use to change settings and properties.

Button	Function
	<p><b>Connection Properties:</b></p> <p>This button manages streaming video performance over <i>your</i> connection to the target server. The settings are stored persistently for the accessed KVM port.</p> <p>In addition, this button can show information like FPS and video resolution.</p> <p>The factory default settings are ideal for most connections so it is not recommended to change the settings unless required.</p>
	<p><b>Keyboard:</b></p> <p>This button shows a list of available hot key macros and sends the selected macro to the target server.</p>
	<p><b>Mouse:</b></p> <p>This button switches between single mouse and various dual mouse modes, or synchronizes two mouse pointers onscreen.</p>
	<p><b>Video Settings:</b></p> <p>This button adjusts video sensing and color calibration settings.</p>
	<p><b>USB Devices:</b></p> <p>This button connects or disconnects a virtual media drive from the target server, if the target supports virtual media.</p> <p>For example, you can mount a CD-ROM or USB flash drive onto the target server.</p> <p>In addition, you can configure the audio connection to the target server.</p>
	<p><b>Power Control:</b></p> <p>This button turns on, off or power cycles the target server, if a Raritan PDU is connected to the same KVM switch.</p>

Button	Function
	<p><b>View:</b></p> <p>This button shows several display options, such as Scale Video and Full-Screen Mode.</p>

The right group comprises the following shortcut buttons for frequently-used functions. These functions are also available in the left group, but the shortcut buttons allow quick access with a click.

Button	Function
	<p><b>Synchronize Mouse:</b></p> <p>This button forces the target server's mouse pointer to align with the User Station's in the dual mouse modes.</p>
	<p><b>Auto-sense Video:</b></p> <p>This button forces the video re-sensing to adjust the video display.</p>
	<p><b>Send Ctrl+Alt+Del:</b></p> <p>This button sends the hot key <i>Ctrl+Alt+Del</i> to the target server to ensure it is interpreted by that server.</p>
	<p><b>Full-Screen Mode:</b></p> <p>This button displays the target server's video in full screen.</p> <p>Press <i>Ctrl+Alt+F</i> to quit the Full-Screen mode.</p>
	<p><b>Fit window to Target:</b></p> <p>This button resizes the KVM Client window to the target server's desktop video.</p>

For detailed information on the toolbar buttons, see **Using the KVM Client** (on page 45).

## Basic Network Settings

The User Station's default network configuration is set to Automatic (DHCP) for both IPv4 and IPv6 settings.

This section describes basic network configuration only. For details, see **Network Connections** (on page 111).

► **To configure basic network settings:**

1. Choose Main Menu > System Settings > Network Connections.

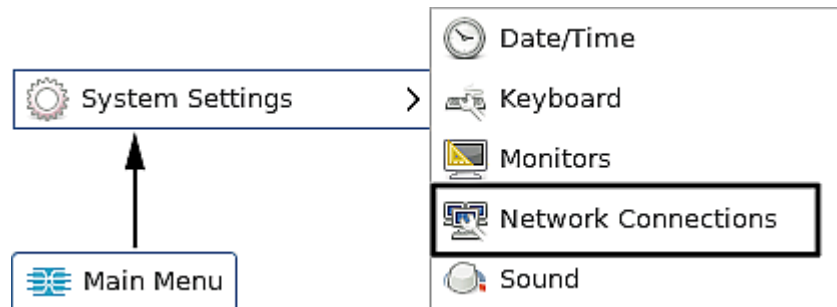

2. In the Network Connections dialog, two default network connections are available for the two LAN ports. *enp2s0* is for the LAN port near the power jack, and *enp3s0* is for the other.

Select the desired one and click Edit.

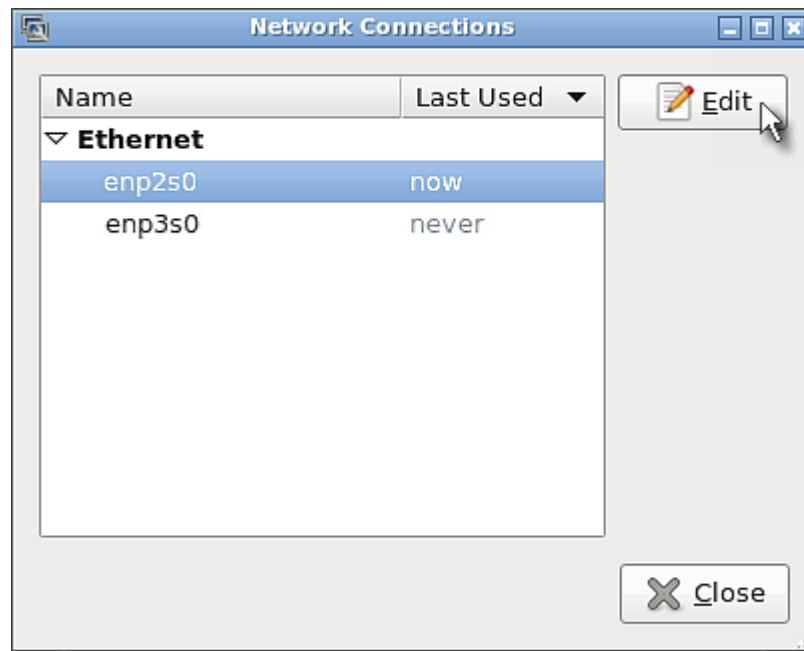

3. Click the IPv4 Settings tab.

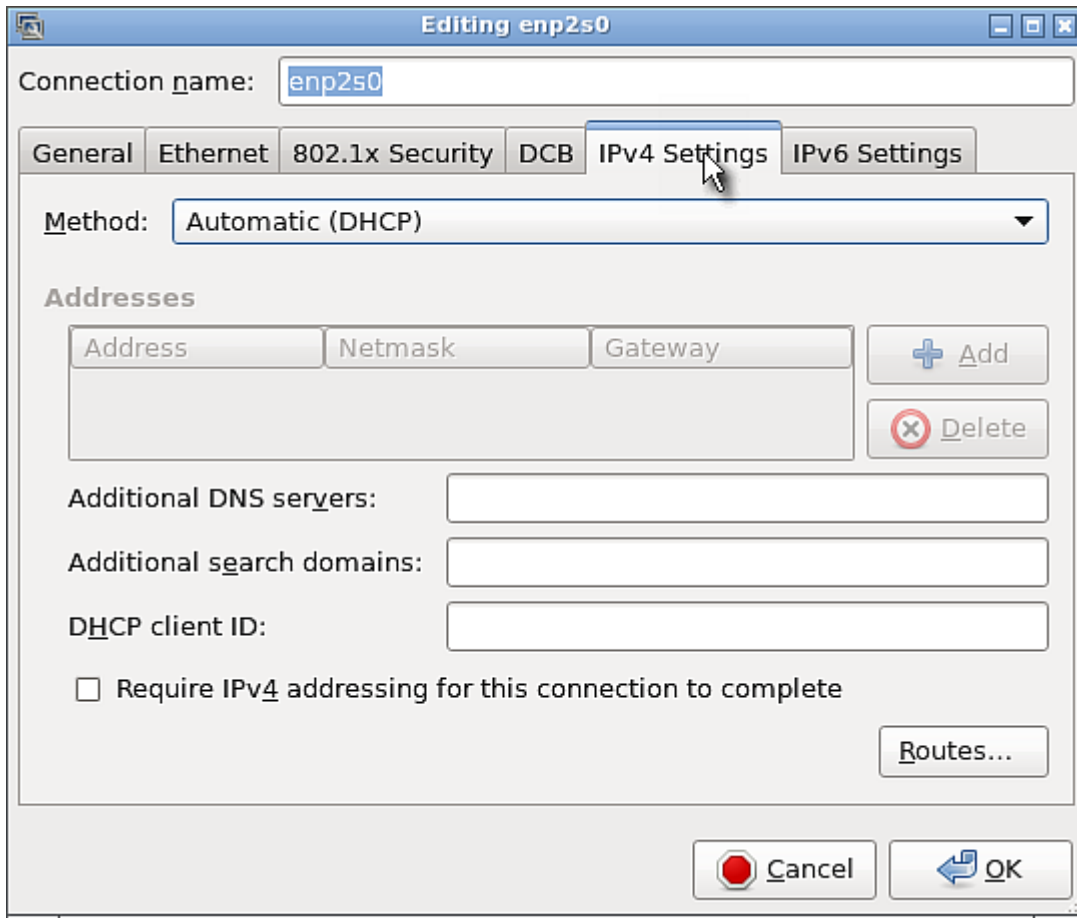

4. In the Method field, select one of the following options:
  - *Automatic (DHCP)*: The DHCP server automatically assigns an IPv4 address. This is the default.
  - *Manual*: This option configures static addressing. Click Add to specify at least one IPv4 address, netmask and gateway.
  - *Disabled*: IPv4 networking is disabled.

For details, see **IPv4 Settings** (on page 113).

5. If your network supports IPv6, click the IPv6 Settings tab, and repeat the above step for configuring IPv6 settings. Note that IPv6 provides the "Ignore" option instead of the "Disabled" option to disable the IPv6 networking. See **IPv6 Settings** (on page 117).
6. Click OK. The new network settings apply now.

## Logout or Shutdown

Both logout and shutdown commands are available under Leave in the Main Menu.

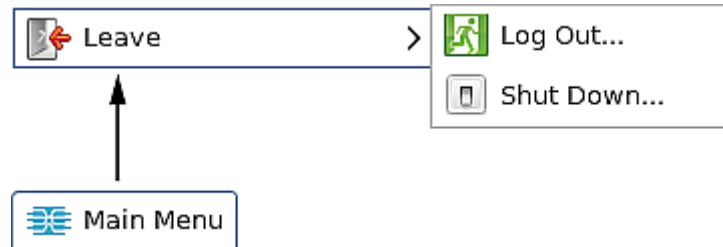

- *Log Out*: Logs the user out of the User Station.
- *Shut Down*: Provides the following options. Click the one you prefer, or the User Station will automatically shut down in one minute.

**Suspend**: Enters the power-saving mode.

**Restart**: Restarts the User Station.

**Shut Down**: Powers off the User Station. You shall always use the software command as the only method to power off your User Station.

Warning: Do NOT turn it off by directly pressing the Power button on the User Station or unplugging the power cord because such operations may damage the User Station.

## VESA Mount (Optional)

You can mount the Dominion User Station onto the back of a monitor with 75 or 100 mm VESA standards.

Below shows the VESA MOUNT kit:



### ▶ VESA mount procedure:

1. Turn OFF and disconnect all devices from the power sources, including the monitor.

2. Attach the VESA mount securely to the back of your monitor using four appropriate screws.

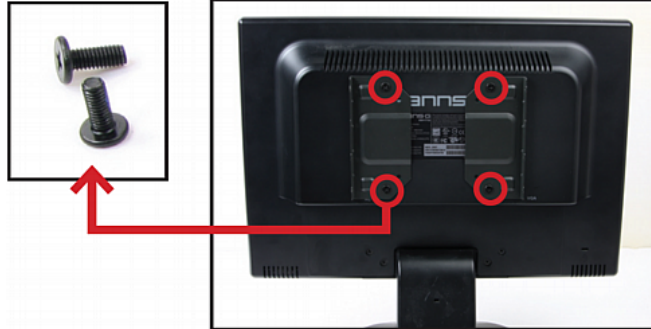

3. Align two screw holes on each side of the User Station with those on the VESA mount.



4. Tighten two sides securely using four appropriate screws.

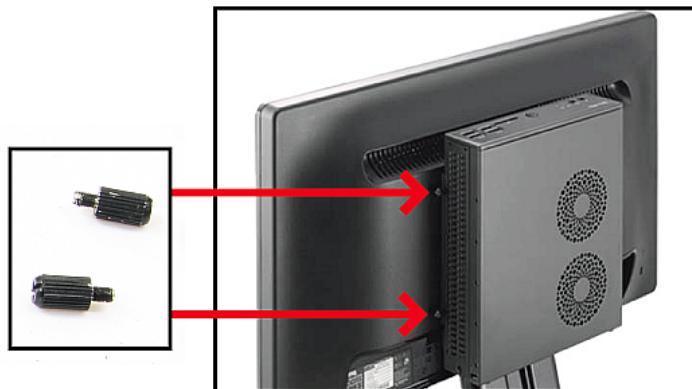

5. The Dominion User Station is now securely attached to the monitor.



---

### Rackmount Using L-type Brackets (Optional)

To mount the User Station in a 19-inch data center rack, you must purchase the L-type rackmount kit from Raritan. One rackmount kit contains two L-type brackets, the cable-support bar and a number of screws.

The following diagram shows the L-type bracket.

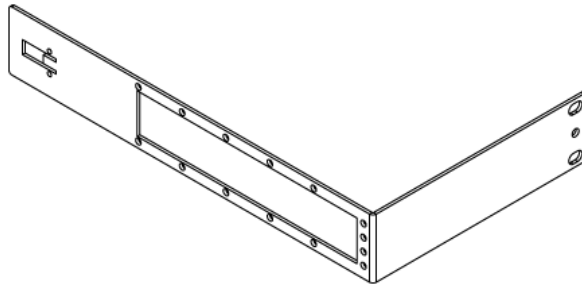

► **To rackmount the User Station using L-type brackets:**

1. Attach the L-type brackets to two sides of the User Station, using the included screws.

2. Secure the cable-support bar to the back end of the L-type brackets, using two of the included screws.

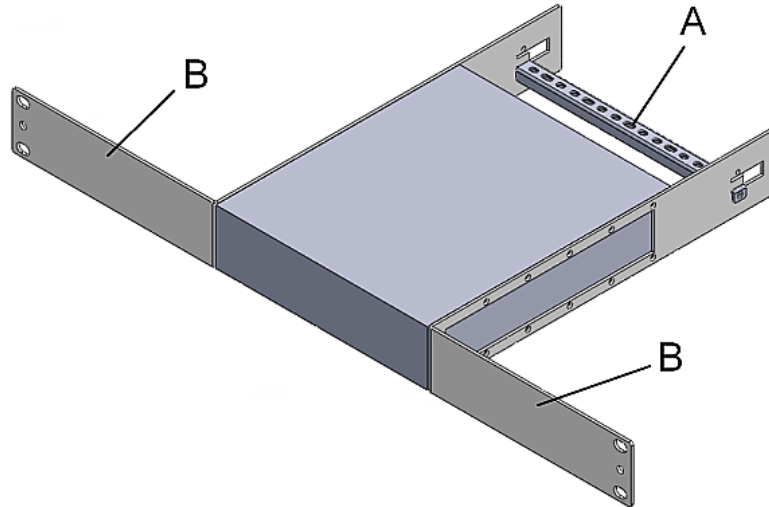

Letter	Item
A	Cable-support bar
B	Front arms of the L-type brackets

3. Attach the L-type brackets to the rack through the screw holes on the front arms, using your fasteners.



# Chapter 3 Managing KVM Switches and Ports

KVM switches and their KVM ports are added, configured and deleted in the User Station Configuration window.

## In This Chapter

User Station Configuration .....	27
Adding KVM Switches .....	29
Editing KVM Switches .....	30
Deleting KVM Switches .....	31
Configuring KVM Ports.....	31

---

## User Station Configuration

The User Station Configuration window is not displayed by default.

► **To launch this window:**

- Press *Ctrl+Alt+C*.
- OR choose Main Menu > User Station Configuration.

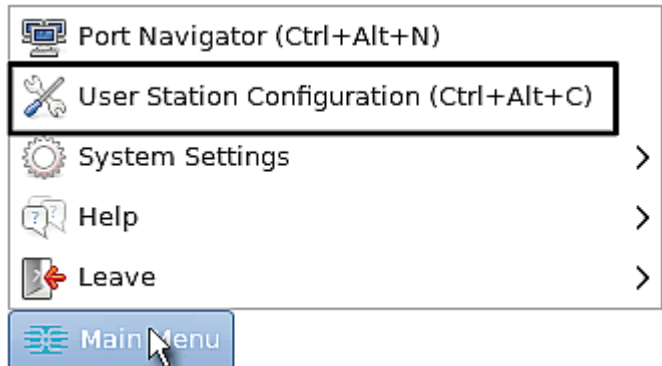

The User Station Configuration window opens.

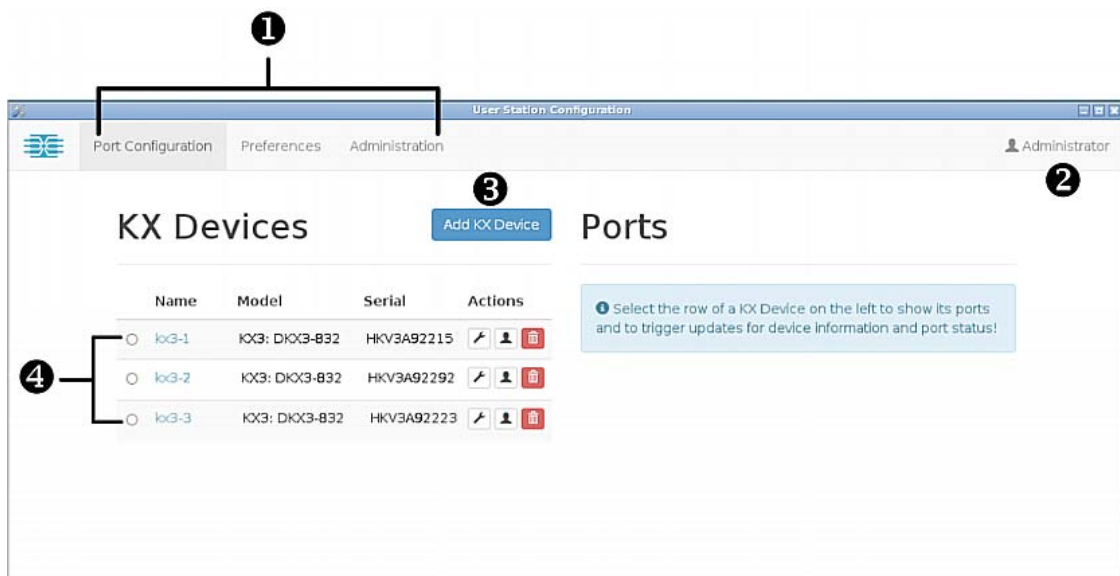

1. **Three configuration tabs:**

- *Port Configuration:* Manage KVM switches and KVM ports. See the other sections in this chapter.
- *Preferences:* Set personal preferences, such as audio settings. See **Setting User Preferences** (on page 74).
- *Administration:* Manage administration and maintenance tasks. See **Administration Features** (on page 81).

2. **Your user account:**

You can click it to view your user account's settings.

3. **Add KX Device** (Add KX Device button):

This button adds KVM switches. See **Adding KVM Switches** (on page 29) or **Step 3: Add KX III KVM Switches** (on page 13).

4. **A list of added KVM switches:**

Click the desired KVM switch's name to view its details, or its radio button to show all of its KVM ports.

## Adding KVM Switches

All KX III KVM switches added to this User Station can be seen by all users who log in to this User Station although they can only access those switches if they have provided the proper user credentials. See **Editing KVM Switches** (on page 30).

► **To add a KVM switch:**

1. Click this button  in the User Station Configuration window. See **User Station Configuration** (on page 27).
2. The following page opens, and the user must enter the required information. See **Step 3: Add KX III KVM Switches** (on page 13).

### Add new KX Device

Network Address

\* IP Address / Hostname



---

User Credentials

\* Username

\* Password

Add KX Device
Cancel

3. After clicking  to save the data, the new KVM switch's content is shown. Click one of these buttons according to your needs.
  - Back: Return to the KX Devices page.
  - Edit: Modify the IP address or host name of this KVM switch.

- Edit User Credentials: Modify the user credentials of this KVM switch.
- Delete: Delete this KVM switch.

---

**Important: User credentials for querying a KVM switch's information are saved on a per-user basis. Other users must enter and save their own user credentials again for the KVM switches you added. See *Authentication of User Stations and KVM Switches* (on page 133).**

---

## Editing KVM Switches

Added KVM switches are listed in the User Station Configuration window.

Each KVM switch has one to three icons in the Actions column, depending on your privileges on the User Station. Two of the buttons in the Actions column are used to modify the IP address/host name and user credentials of the KVM switch.

If you are not the one who added new KVM switches to the User Station, you must follow the procedure below to enter user credentials for newly-added KVM switches.

---

*Note: For the difference between a KVM switch's and the User Station's user credentials, see **Authentication of User Stations and KVM Switches** (on page 133).*

---

Name	Model	Serial	Actions
KX3	KX3: DKX3-832	HKV3A92215	    

► **To change the KVM switch's IP address/host name:**

1. Click the desired KVM switch's  button.
2. Modify the IP address or host name.
3. Click Update KX Device.

► **To enter new user credentials for a KVM switch:**

1. Click the  button of the desired KVM switch.
2. Enter new user credentials.
3. Click Save.

---

*Note: If you enter incorrect user credentials for a KVM switch, and the User Blocking feature has been enabled on that KVM switch, you will be automatically blocked by that KVM switch because the User Station tries accessing it for several times. When this occurs, contact the KVM switch's system administrator for help.*

---

## Deleting KVM Switches

The final button in the Actions column is used to delete this KVM switch.

Name	Model	Serial	Actions
lx3	KX3: DKX3-832	HKV3A92215	

► **To delete a KVM switch:**

1. Click the desired KVM switch's button.
2. Click OK on the confirmation message.

## Configuring KVM Ports

A KVM switch's ports are shown only after a KVM switch is selected.

► **To configure a KVM port:**

1. Select the desired KVM switch, and all of its KVM ports are listed on the screen.
  - If a KVM port shows  in its Fav column, it has been configured as a favorite port.
  - If a KVM port shows  in its Fav column, it is not set as a favorite port.

*Note: The icon shown in the top-right corner of the "Ports" section indicates the KVM port information retrieval status. See **Port Data Retrieval Status** (on page 34).*

KX Devices				Ports							
Name	Model	Serial	Actions	No	Name	Type	Status	Avail	Hotkey	Fav	Action
<input checked="" type="radio"/> kx3-1	KX3: DKX3-832	HKV3A92215		1	Port1	VM	up	connected		<input type="checkbox"/>	
<input type="radio"/> kx3-2	KX3: DKX3-432	HKS3A92204		2	Port2	VM	up	idle		<input type="checkbox"/>	
				3	Port3	VM	up	idle		<input type="checkbox"/>	
				4	Port4	VM	up	idle		<input type="checkbox"/>	
				5	Port5		down	idle		<input type="checkbox"/>	
				6	Port6		down	idle		<input type="checkbox"/>	

- Click in the Action column of the KVM port that you want to configure. A page similar to the following appears.

## Settings for Port 2

### Hotkey

Enabled   +

Is favorite

Auto connect audio

- Configure the port as needed.

Checkbox	Function
Enabled	<p>Assign a hot key combination for quickly accessing this KVM port. Available options include:</p> <ul style="list-style-type: none"> <li>▪ <i>Ctrl + Shift + &lt;character&gt;</i></li> <li>▪ <i>Ctrl + Alt + &lt;character&gt;</i></li> <li>▪ <i>Shift + Alt + &lt;character&gt;</i></li> <li>▪ <i>Ctrl + Shift + Alt + &lt;character&gt;</i></li> </ul> <p>&lt;character&gt; is an alphanumeric character or function key.</p> <p>Note that some hot key combinations do NOT work for accessing any KVM port. See <b>Invalid Hot Keys for Port Access</b> (on page 33).</p>
Is favorite	<p>If this checkbox is selected, this KVM port is shown in the Favorite Ports panel. See <b>Port Navigator</b> (on page 38).</p>
Auto connect audio	<p>Select this checkbox to transmit audio signals between the User Station and the server connected to this KVM port.</p> <p>This checkbox is configurable only when the KVM port supports audio transmission via Virtual Media.</p>

---

*Tip: If you do NOT select the "Auto connect audio" checkbox, you can manually establish the audio connection after accessing this KVM port. See **Audio** (on page 69).*

---

4. Click Save.

---

#### Invalid Hot Keys for Port Access

Do NOT use any of the following hot key combinations for accessing KVM ports.

Invalid hot key	Note
Ctrl + Shift + <number>	<number> = 0 to 9
Ctrl + Shift + Alt + <number>	
Shift + Alt + <number>	
Ctrl + Alt + <function_key>	<function_key> = F1 to F12
Ctrl + Alt + N (or n)	The pre-programmed hot key for launching the Port Navigator window

Invalid hot key	Note
Ctrl + Alt + C (or c)	The pre-programmed hot key for launching the User Station Configuration window

Besides, it is not recommended to use the following hot keys because they may interfere with the pre-programmed hot keys for quitting full screen and single mouse modes in the KVM Client.

- Ctrl + Alt + F
- Ctrl + Alt + M

### Port Data Retrieval Status

An icon is displayed in the top-right corner of the "Ports" section in the User Station Configuration window. This icon indicates the data retrieval status of the KVM ports on the selected KVM switch.

## Ports





No	Name	Type	Status	Avail	Hotkey	Fav	Action
1	Port1	VM	up	connected		<input type="checkbox"/>	
2	Port2	VM	up	idle		<input type="checkbox"/>	
3	Port3	VM	up	idle		<input type="checkbox"/>	
4	Port4	VM	up	idle		<input type="checkbox"/>	
5	Port5		down	idle		<input type="checkbox"/>	



You can click this icon to view additional information.

The icon changes depending on the current retrieval status of KVM port information.

Icon	Port data retrieval state
	Port information on the selected KVM switch is accessible.
	<p>Port information on the selected KVM switch is NOT accessible.</p> <p>Possible causes may include:</p> <ul style="list-style-type: none"> <li>▪ Incorrect user credentials are entered for the KVM switch.</li> <li>▪ Network connectivity issues. For example, the selected KVM switch is not connected to the network.</li> <li>▪ The Single Login Limitation has been enabled on the selected KVM switch, and a User Station's port status retrieval program or another user has consumed the single login.</li> </ul>
	Port information on the selected KVM switch is NOT accessible because NO user credentials have been entered for this KVM switch. See <b><i>Editing KVM Switches</i></b> (on page 30).

The port data retrieval status will affect the device and port status shown in the Port Navigator window. See ***Identifying States of KVM Switches and Ports*** (on page 40).

# Chapter 4 Navigation and Access to KVM Ports

## In This Chapter

Overview.....	37
Port Navigator.....	38
Identifying States of KVM Switches and Ports .....	40
Using Search .....	42
Using Filters.....	43

## Overview

Port access is performed in the Port Navigator window, which contains three panels for accessing KVM ports: *Favorite Ports*, *Devices* and *Ports*. By default, the *Devices* panel has been opened.

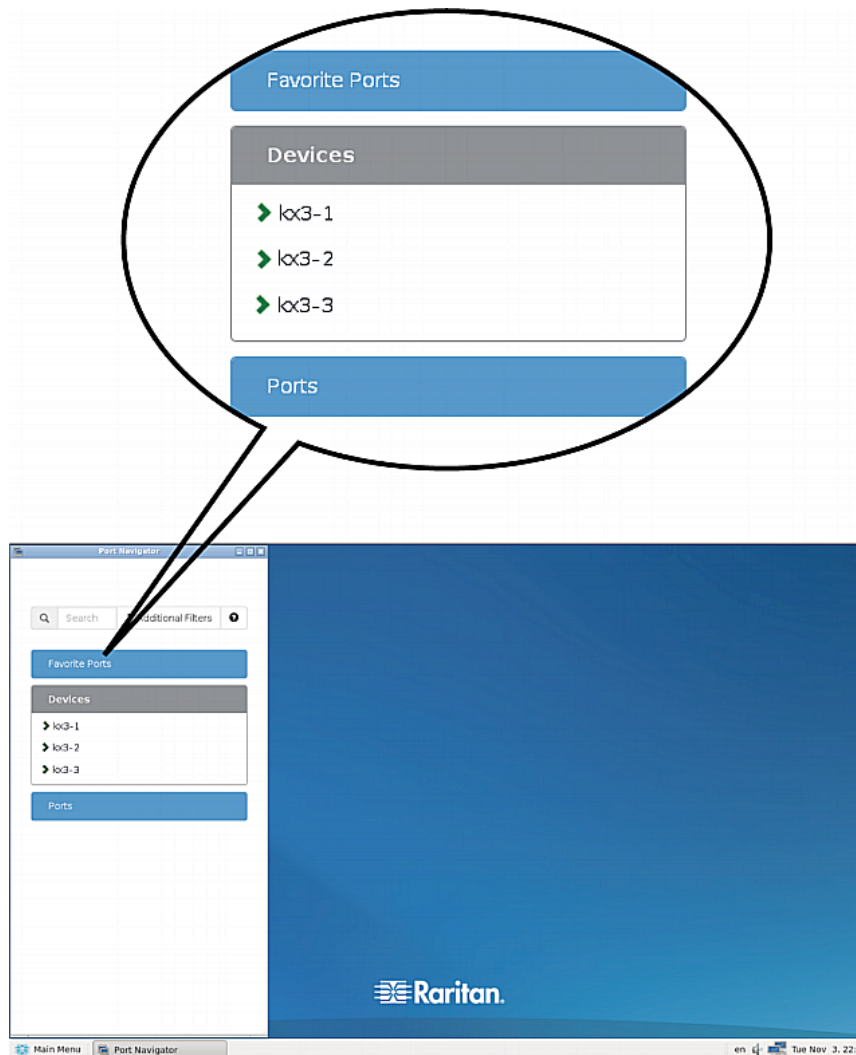

► **To access a KVM port:**

1. Click a panel.  
Once opened, the panel color turns gray.
2. Click a KVM switch if the panel you opened is the *Devices* panel.
3. Click a KVM port.

For details, see **Step 4: Access KVM Switches and KVM Ports** (on page 15).

*Note: The User Station CANNOT access a KVM port that is connected to a KVM switch or a blade chassis server. Therefore, such KVM ports are not shown in the Port Navigator window.*

## Port Navigator

The Port Navigator window is displayed by default.

► **To launch Port Navigator:**

- Press *Ctrl+Alt+N*.
- OR choose Main Menu > Port Navigator.

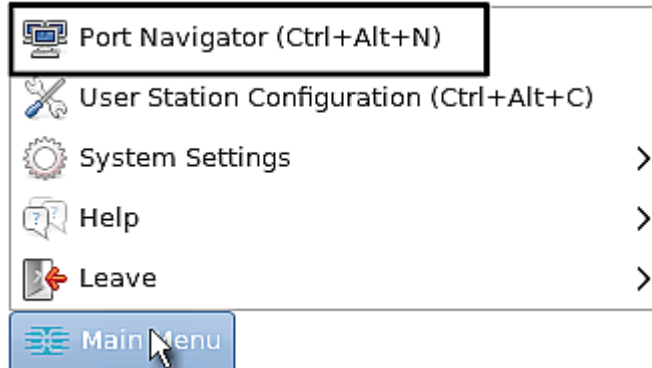

The Port Navigator window opens.

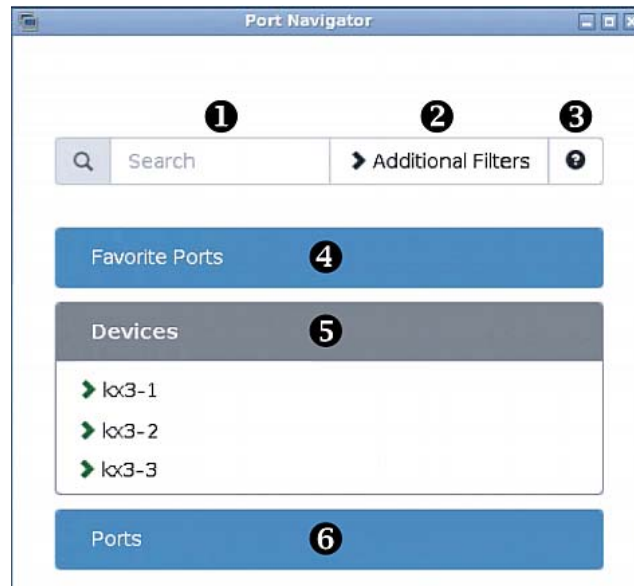

**1. Search:**

Searches for KVM ports or switches containing the search word(s). See **Using Search** (on page 42).

**2. Additional Filters:**

Determines which KVM switches and ports are displayed in this window based on KVM switch and port states. See **Using Filters** (on page 43).

**3. Help :**

Shows the colors and icons denoting KVM switch and port states. See **Identifying States of KVM Switches and Ports** (on page 40).

**4. Favorite Ports panel:**

Shows a list of the favorite KVM ports you have configured. See **Configuring KVM Ports** (on page 31).

**5. Devices panel:**

Shows a list of KVM switches. To view any switch's KVM ports, click the KVM switch.

The default is to show KVM switches whose status is Normal or Unknown. See **Using Filters** (on page 43).

---

*Note: If a KVM switch has the Single Login Limitation enabled, the **User Station's port status retrieval program** will consume the single login while the User Station is operating. On that User Station, this KVM switch is taken as a KVM switch with communication errors so it is not displayed by default.*

---

**6. Ports panel:**

Shows a list of KVM ports.

The default is to show KVM ports whose status is Up. See **Using Filters** (on page 43).





---

## Identifying States of KVM Switches and Ports

In the Port Navigator window, different icons and colors are applied to indicate current states of the added KVM switches and ports.







The same information is available by clicking .

▶ **Port icons:**





Icon	Port state
	Up - no KVM sessions are active
	Down
	Up - at least one KVM session is active
	Busy - an exclusive KVM session is active

▶ **Port icon colors:**





The following table explains the color changes only. Please ignore the icon shapes.



Color	Port state
	Accessible
	Busy
	Error while getting port status
	Down
	Status unknown
	Status being updated

► **KVM switch's icon and colors:**

Icon in color	KVM switch state
	Normal (accessible)
	<ul style="list-style-type: none"> <li>▪ Error while communicating with the KVM switch</li> <li>- OR -</li> <li>▪ Single Login Limitation has been enabled on the KVM switch, and the User Station's port status retrieval program or another user has consumed the single login</li> </ul>
	Status unknown
	Status being updated

► **Examples of KVM port states:**

Icon in color	Port state
	Up, accessible, but no KVM session is active
	Down
	Up, accessible, and at least one KVM session is active
	Up and busy
	Up, but there are network connectivity issues -- for example, the selected KVM switch is not connected to the network

Icon in color	Port state
	Down, but there are network connectivity issues
	Up, accessible, but Single Login Limitation has been enabled on the KVM switch and the User Station's port status retrieval program has consumed the single login

---

*Note: The KVM port data retrieval status will impact the device and port status shown in the Port Navigator window. See **Port Data Retrieval Status** (on page 34).*

---

## Using Search

The search box allows you to search for the KVM ports or switches that match the user's search words.



► **To search for KVM ports or switches:**

1. Open the panel where you want to perform the search function.
  - To search for a KVM switch, click the Devices panel.
    - To search KVM ports of a specific KVM switch in addition to KVM switches, you can click the desired KVM switch to have its KVM ports displayed prior to using the Search function.

---

*Note: The User Station will NOT search the KVM ports of those unselected KVM switches in the Devices panel.*

---

- To search for a KVM port only, click the Ports panel.
  - To search for a "favorite" KVM port, click the Favorite Ports panel.
2. Type the search word(s) in the Search box. Words are case sensitive.
  3. The currently opened panel immediately shows the search result.
    - If no KVM ports are found, the panel displays this message -- *No port found.*
    - If no KVM devices are found, the panel displays this message -- *No device found.*



## Using Filters

Per default, the Port Navigator window only shows KVM switches that can be communicated properly, and the KVM ports that are up. You can change the display criteria by using filters.



► **To change the filter:**

1. Click Additional Filters, and the following checkboxes will appear.

### Device Connectivity

- Normal
- Error
- Unkown

### Port State and Availability

- Up and Idle
- Up and Connected
- Up and Busy
- Down

2. Select or deselect any checkboxes to determine what kinds of KVM switches and KVM ports are shown.

Checkbox	KVM switch's state
Normal	The KVM switch can communicate with the User Station, and the device state is normal.
Error	The KVM switch cannot communicate with the User Station.
Unknown	The KVM switch can communicate with the User Station but cannot determine its device state.

Checkbox	KVM port's state
Up and Idle	The port is up, accessible and no KVM sessions are active.
Up and Connected	The port is up, and at least one KVM session is active.
Up and Busy	The port is up, but busy because an exclusive KVM session is active.
Down	The port is down.

3. When completed, click Additional Filters to hide the options.

## Chapter 5 Using the KVM Client

A KVM Client window opens after accessing a KX III KVM port where a server is physically connected.

The server connected to a KVM port is called the *target server*.

The Dominion User Station's KVM Client settings are configured through the toolbar only. No menu bar is available.

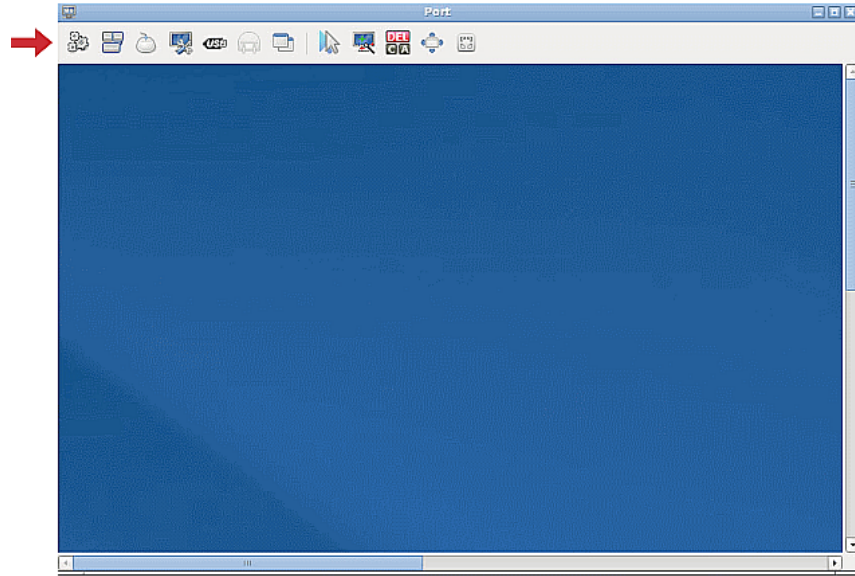

### In This Chapter

Connection Properties .....	46
Keyboard/Hot Key Settings .....	50
Mouse Settings .....	51
Video Settings .....	56
USB Settings .....	61
Power Control .....	70
View Settings .....	71

## Connection Properties

Connection properties manage streaming video performance over connections to target servers. The properties are applied only to your connection, not the connection of other users accessing the same target server.

► **To configure connection properties:**

1. Click  to open the Connection Properties dialog.

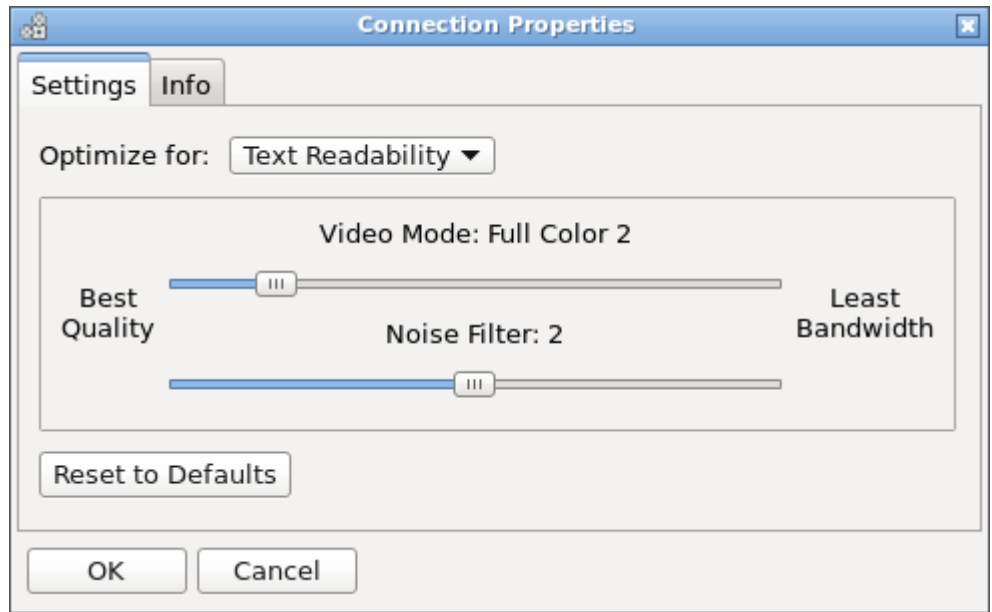

2. The default connection settings are the optimal settings for video performance most of the time. Do NOT make changes unless required. See **Default Connection Properties** (on page 48).

Setting	Description
Optimize for	Determine which aspect of video data is optimized for. There are two options: <ul style="list-style-type: none"> <li>▪ <b>Text Readability</b> (on page 49)</li> <li>▪ <b>Color Accuracy</b> (on page 49)</li> </ul>

Setting	Description
Video Mode	This slider controls the video quality as well as the bandwidth. <ul style="list-style-type: none"> <li>▪ Left: higher quality with higher bandwidth consumed.</li> <li>▪ Right: lower quality with less bandwidth consumed. This is useful for low-bandwidth connections.</li> </ul> See <b>Video Mode</b> (on page 49).
Noise Filter	This slider controls the noise filter threshold. <ul style="list-style-type: none"> <li>▪ Left: higher threshold.</li> <li>▪ Right: lower threshold.</li> </ul> See <b>Noise Filter</b> (on page 50).
Reset to Defaults	Reset connection properties to the factory defaults.

3. Click OK to save any changes made. The settings are stored persistently for the accessed KVM port.

► **To view connection information:**

- Click the Info tab in the same dialog.

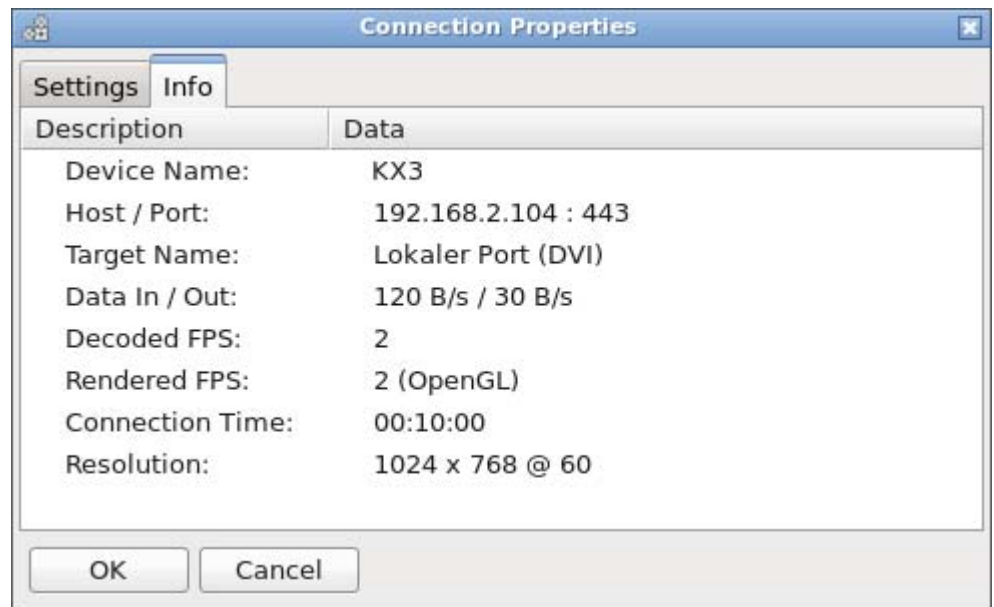

Item	Description
Device Name	The KVM switch's name.

Item	Description
Host / Port	The KVM switch's IP address, and the TCP/IP port used to access the KVM switch.
Target Name	The accessed KVM port's name.
Data In / Out	Rate of data received and sent out to the KVM switch in bytes per second.
Decoded FPS	Number of frames per second that were received and decoded by the KVM Client.
Rendered FPS	Number of frames per second that were displayed onscreen. Usually this number is similar to "Decoded FPS", but it may be lower on high graphics demand.
Connection Time	Duration of the current connection.
Resolution	Video resolution of the target server connected to this KVM port.

---

### Default Connection Properties

The Dominion User Station comes configured to provide optimal performance for the majority of video streaming conditions.

Default connection settings are:

- **Optimized for: Text Readability** - video modes are designed to maximize text readability.  
This setting is ideal for general IT and computer applications, such as performing server administration.
- **Video Mode** - defaults to Full Color 2.  
Video frames transmit in high-quality, 24-bit color. This setting is suitable where a high-speed LAN is used.
- **Noise Filter** - defaults to 2.  
The noise filter setting does not often need to be changed.

---

**Text Readability**

Text Readability is designed to provide video modes with lower color depth but text remains readable. Greyscale modes are even available when applying lower bandwidth settings.

This setting is ideal when working with computer GUIs, such as server administration.

When working in full color video modes, a slight contrast boost is provided, and text is sharper.

In lower quality video modes, bandwidth is decreased at the expense of accuracy.

---

**Color Accuracy**

When Color Accuracy is selected, all video modes are rendered in full 24-bit color with more compression artifacts.

This setting applies to viewing video streams such as movies or other broadcast streams.

In lower quality video modes, sharpness of fine detail, such as text, is sacrificed.

---

**Video Mode**

The Video Mode slider controls each video frame's encoding, affecting video quality, frame rate and bandwidth.

In general, moving the slider to the left results in higher quality at the cost of higher bandwidth and, in some cases, lower frame rate.

Moving the slider to the right enables stronger compression, reducing the bandwidth per frame, but video quality is reduced.

In situations where system bandwidth is a limiting factor, moving the video mode slider to the right can result in higher frame rates.

When Text Readability is selected as the Optimized setting, the four rightmost modes provide reduced color resolution or no color at all.

These modes are appropriate for administration work where text and GUI elements take priority, and bandwidth is at a premium.

---

### Noise Filter

Unless there is a specific need to do so, do not change the noise filter setting. The default setting is designed to work well in most situations.

The Noise Filter controls how much interframe noise is absorbed by the Dominion User Station.

Moving the Noise Filter slider to the left lowers the filter threshold, resulting in higher dynamic video quality. However, more noise is likely to come through, resulting in higher bandwidth and lower frame rates.

Moving the slider to the right raises the threshold, allows less noise and less bandwidth is used. Video artifacts may be increased.

Moving the noise filter to the right may be useful when accessing a computer GUI over severely bandwidth-limited connections.

---

### Keyboard/Hot Key Settings

Click  to select one of the pre-programmed hot key macros.



Send Ctrl+Alt+Del  
Send LeftAlt+Tab

---

*Note: If you have manually created any hot key macros and have them enabled, these macros are displayed below "Send LeftAlt+Tab." See **Keyboard Macros** (on page 74).*

---

► **Send Ctrl+Alt+Del:**

To send this key sequence to the target server you are accessing:

- Click  > Send Ctrl+Alt+Del.
- OR click  .

Warning: If you physically press *Ctrl+Alt+Del* using the keyboard, the command is first intercepted on the User Station, instead of sending the key sequence to the target server.

► **Send LeftAlt+Tab:**

This hot key macro switches between open windows on the target server you are accessing.



---

## Mouse Settings

You can operate in either single mouse mode or dual mouse mode.

Single mouse mode displays only one mouse pointer while dual mouse mode displays two.

In any mouse mode, when the mouse pointer lies within the KVM Client's target server window, mouse movements and clicks are directly transmitted to the target server.

Click  to select one mouse command or mode.

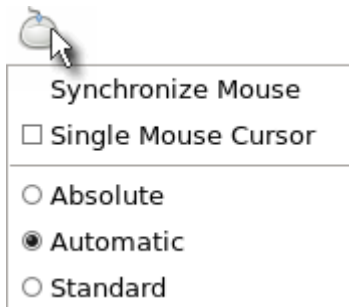

Single Mouse Cursor is for single mouse mode. Absolute, Automatic and Standard are the dual mouse modes.

---

**Important: Make sure you have configured mouse settings on the target servers properly. For information on configuring mouse settings of target servers, refer to the KX III KVM switch's user documentation from its application or the Dominion KX III section of the Raritan website's *Support page* (<http://www.raritan.com/support>).**



---

---

### Synchronize Mouse

In the dual mouse mode, the Synchronize Mouse command forces realignment of the target server's mouse cursor with the User Station's. See **Dual Mouse Modes** (on page 53).

► **To synchronize the mouse cursors:**

- Click  > Synchronize Mouse.
- OR click .

---

*Note: This option is available in Automatic and Standard mouse modes only. However, mouse synchronization may not always be successful with this option. When this occurs, first check **Mouse Synchronization Tips** (on page 55). If the mouse synchronization issue still cannot be resolved, enter the Absolute or single mouse mode. See **Single Mouse Cursor** (on page 52) and **Absolute Mouse Mode** (on page 53).*

---

### Single Mouse Cursor

In the single mouse mode, you only use the target server's mouse cursor, and the User Station's mouse cursor no longer appears onscreen.

On fast LAN connections, you can use single mouse mode, and view only the target server's pointer.

► **To enter the single mouse mode:**

1. Click  > Single Mouse Cursor.
2. Click OK on the confirmation message.

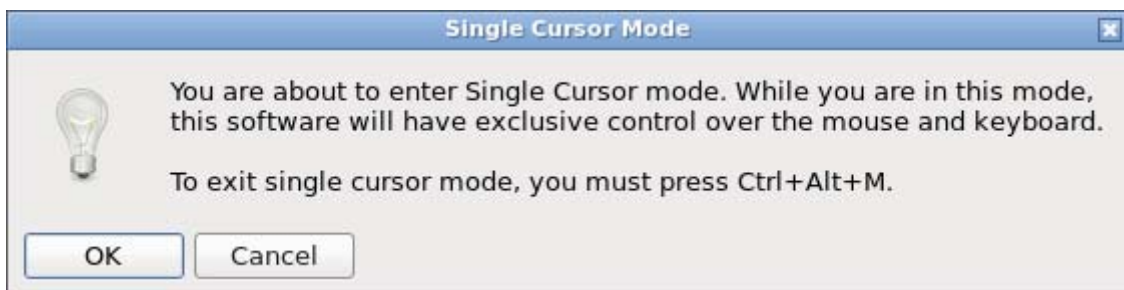

► **To exit the single mouse mode:**

- Press Ctrl+Alt+M on your keyboard.

---

### Dual Mouse Modes

In the dual mouse modes, two cursors appear onscreen. They are:

- The mouse cursor of the User Station.
- The mouse cursor of the target server connected to the KVM port you are accessing.

Two mouse cursors align if properly configured.

While in motion, the User Station's mouse pointer slightly leads the target server's mouse pointer.

### Absolute Mouse Mode

In this mode, absolute coordinates are used to keep the User Station's and target server's cursors in synch, even when the target server's mouse is set to a different acceleration or speed.

This mode is supported on target servers with USB ports and is the default mode for virtual media CIMs.

Use of virtual media CIMs on target servers is required for this mouse mode. See **Virtual Media CIMs** (on page 68).

Most modern operating systems on the target servers shall support the Absolute mouse mode.

---

*Note: Some Linux, UNIX, Solaris or very "unusual" operating systems as well as some USB profiles may not support the Absolute mouse mode. In this case, use other mouse modes. For detailed information of each USB profile, see the section titled "Available USB Profiles" in the user documentation of the KX III KVM switch, which is accessible from the KVM switch application or the Raritan website's **Support page** (<http://www.raritan.com/support/>).*

---

#### ► To enter the Absolute mouse mode:

- Click  > Absolute.

### Automatic Mouse Mode

In this mode, the User Station can detect the target server's mouse settings and synchronize the mouse cursors accordingly, allowing mouse acceleration on the target server.

This mode is the default for non-VM target servers.

---

*Note: A non-VM target server is the target server using a CIM that does not support virtual media.*

---

▶ **To enter the Automatic mouse mode:**

- Click  > Automatic.

▶ **Automatic mouse synchronization requirements:**

The Synchronize Mouse command automatically synchronizes mouse cursors during moments of inactivity in the Automatic mouse mode. See **Synchronize Mouse** (on page 52).

For this to work properly, the following conditions must be met:

- The active desktop should be disabled on the target server.
- No windows should appear in the top-left corner of the target server's page.
- There should not be an animated background in the top-left corner of the target server's page.
- The target server's mouse cursor shape should be normal and not animated.
- The target server's mouse speeds should not be set to very slow or very high values.
- Advanced mouse properties such as "Enhanced pointer precision" or "Snap mouse to default button in dialogs" should be disabled on the target servers.
- Choose "Best Possible Video Mode" in the Video Settings dialog of the KVM Client.
- The edges of the target server's video should be clearly visible (that is, a black border should be visible between the target server's desktop and the KVM Client window when you scroll to an edge of the target video image).

After autosensing the target server's video, manually perform the Synchronize Mouse command. This also applies when the resolution of the target server changes if the mouse cursors start to desync from each other.

If automatic mouse synchronization fails, this mode will revert to standard mouse synchronization behavior. See **Standard Mouse Mode** (on page 55).

Note that mouse configurations will vary on different target servers' operating systems. Consult your OS guidelines for further details.

---

*Note: Automatic mouse synchronization does not work with UNIX target servers.*

---

### Standard Mouse Mode

Standard mouse mode uses a standard mouse synchronization algorithm. The algorithm determines relative mouse positions on the User Station and target server.

In order for the User Station's and target server's mouse cursors to stay in synch, mouse acceleration must be disabled. Additionally, specific mouse parameters must be set correctly.

#### ► To enter the Standard mouse mode:

- Click  > Standard.



---

### Mouse Synchronization Tips

If you have an issue with mouse synchronization:

1. Verify that the selected video resolution and refresh rate are among those supported by your User Station. See **Monitors** (on page 109).

The KVM Client's Connection Properties dialog displays the actual values the User Station is seeing.

2. Force a video auto-sense by clicking the KVM Client's Auto-sense Video button .
3. If that does not improve the mouse synchronization (for Linux, UNIX, and Solaris target servers):
  - a. Open a terminal window.
  - b. Enter this command: `xset mouse 1 1`
  - c. Close the terminal window.
4. Click the KVM Client's mouse synchronization button .

---

*Note: If the mouse synchronization issue still cannot be resolved, enter the Absolute or single mouse mode. See **Single Mouse Cursor** (on page 52) and **Absolute Mouse Mode** (on page 53).*

---

## Video Settings

Click  to open the Video Settings dialog.

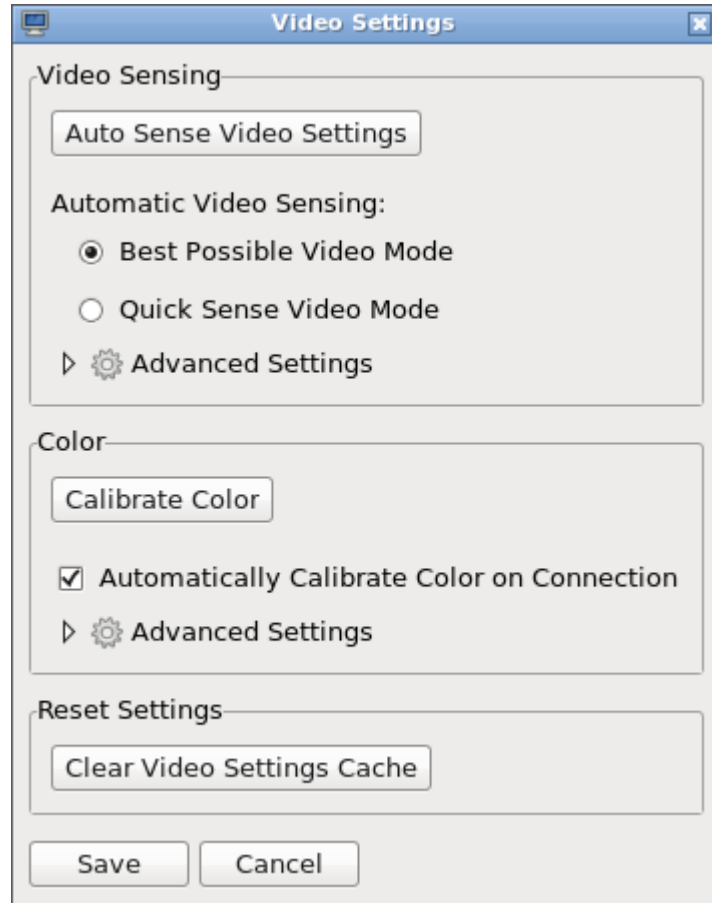

► **Video Sensing settings:**

Setting	Description
Auto Sense Video Settings	<p>This command automatically detects the target server's video settings (resolution, refresh rate) and redraws the video screen.</p> <p>Clicking  in the toolbar results in the same video re-sensing function.</p>

Setting	Description
Best Possible Video Mode	The User Station will perform the full Auto Sense process when switching target servers or target resolutions. Selecting this option calibrates the video for the best image quality.
Quick Sense Video Mode	The User Station will use a quick video Auto Sense in order to show the target server's video sooner.  This option is especially useful for entering a target server's BIOS configuration right after a reboot.
Advanced Settings	Adjusts the clock, phase, horizontal and vertical offset. See <b>Advanced Video Settings</b> (on page 58).

---

*Note: Some Sun background screens, such as screens with very dark borders, may not center precisely on certain Sun servers. Use a different background or place a lighter colored icon in the upper-left corner of the Sun screen.*

---

► **Color settings:**

Setting	Description
Calibrate Color	This command optimizes the color levels (hue, brightness, saturation) of the transmitted video images. The color settings are on a target server-basis.  Note that this command applies to the current connection only.
Automatically Calibrate Color on Connection	Selecting this checkbox causes the User Station to automatically update the color calibration once connected to a target server.
Advanced Settings	Adjusts brightness and contrast levels of red, green and blue colors. See <b>Advanced Color Settings</b> (on page 60).

► **Reset Settings:**

The Clear Video Settings Cache button resets the cache where video settings are stored, which is useful when old video settings no longer apply, such as when a target server is replaced.

After calibrating the colors for a target server, color values are cached and reused whenever accessing that server. Changing resolutions resets the video to the cached values again.

Note that changes to the brightness and contrast levels are NOT cached.

When resetting the video settings cache, the User Station automatically does a video auto-sense and color calibration. New values are cached and reused for accessing that target server next time.

---

### Advanced Video Settings

In the Video Settings dialog, click Advanced Settings in the Video Sensing section to show additional settings.

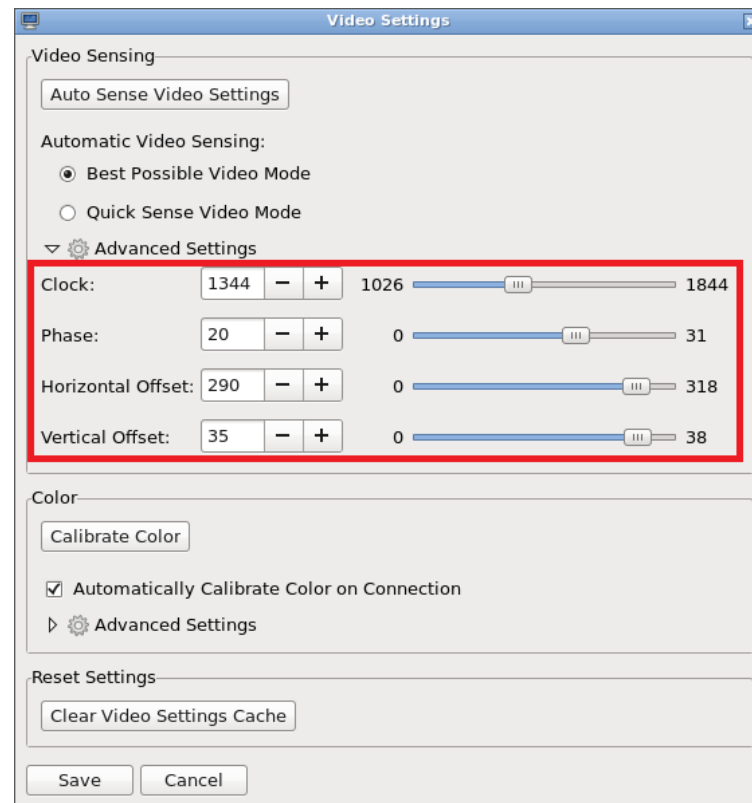



Click  or , drag sliders, or type a new numeric value in the text box to adjust corresponding settings.

Setting	Description
Clock	<p>Controls how quickly video pixels are displayed across the video screen. Changes made to clock settings cause the video image to stretch or shrink horizontally.</p> <p>Under most circumstances, this setting should not be changed because the autodetect is usually quite accurate.</p> <p>Odd number settings are recommended.</p>
Phase	<p>Phase values range from 0 to 31 and will wrap around. Stop at the phase value that produces the best video image for the active target server.</p>
Horizontal Offset	<p>Controls the horizontal positioning of the target server display on your monitor.</p>
Vertical Offset	<p>Controls the vertical positioning of the target server display on your monitor.</p>

### Advanced Color Settings

In the Video Settings dialog, click Advanced Settings in the Color section to show additional color settings.

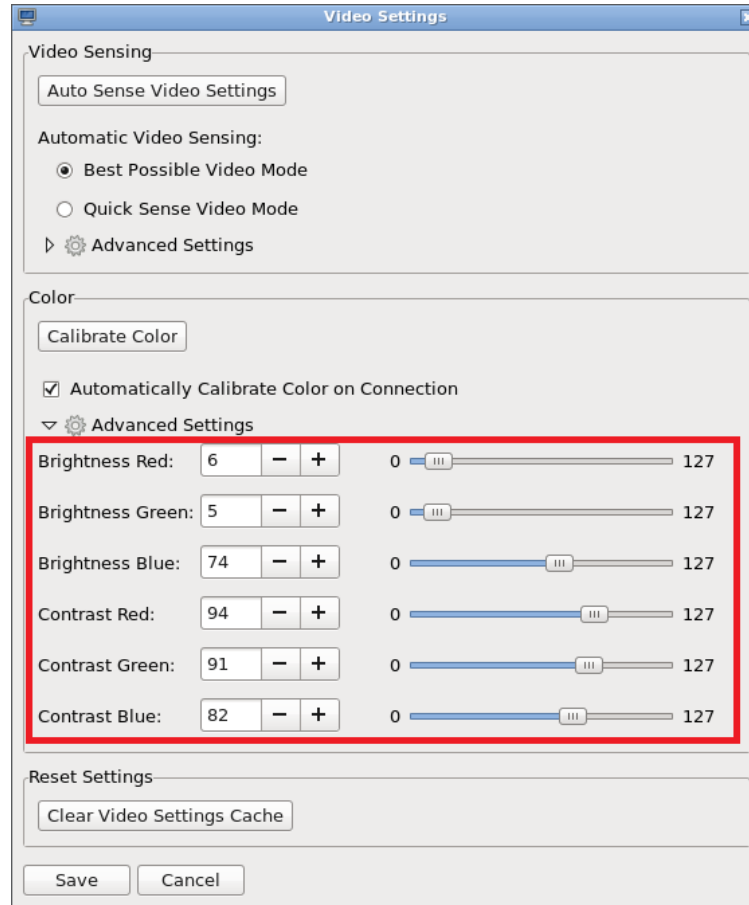

Click  or , drag sliders, or type a new numeric value in the text box to adjust corresponding settings.

Setting	Description
Brightness Red	Controls the brightness of the target server's display for the red signal.
Brightness Green	Controls the brightness of the green signal.
Brightness Blue	Controls the brightness of the blue signal.
Contrast Red	Controls the red signal contrast.

Setting	Description
Contrast Green	Controls the green signal contrast.
Contrast Blue	Controls the blue signal contrast.

## USB Settings

Click **USB** to open the "USB Settings and Devices" dialog.



Setting	Description
Active USB Profile	Select a USB configuration profile that best applies to the target server, and click Apply.  Click the Help button to display information similar to <b>USB Profile Overview</b> (on page 62).
Connect Device	To mount a USB drive, DVD drive, CD-ROM drive, or an ISO image onto the target server, click the Virtual Media button or CD-ROM/ISO button.  See <b>Virtual Media</b> (on page 63).
	To connect an audio device to the target server, click the Audio button. See <b>Audio</b> (on page 69).

*Note: For detailed information of each USB profile, see the section titled "Available USB Profiles" in the user documentation of the KX III KVM switch, which is accessible from the KVM switch application or the Raritan website's **Support page** (<http://www.raritan.com/support/>).*

---

### USB Profile Overview

Raritan provides a standard selection of USB configuration profiles for a wide range of operating system and BIOS-level server implementations. These are intended to provide an optimal match between remote USB device and target server configurations.

The 'Generic' profile meets the needs of most commonly deployed target server configurations.

Additional profiles are made available to meet the specific needs of other commonly deployed server configurations (for example, Linux<sup>®</sup> and Mac OS X<sup>®</sup>).

There are also a number of profiles (designated by platform name and BIOS revision) to enhance virtual media function compatibility with the target server, for example, when operating at the BIOS level.

Administrators configure the KVM port with the USB profiles that best meet the needs of the user, and the target server configuration.

A user connecting to a target server chooses among these preselected profiles in the KVM Client, depending on the operational state of the target server.

For example, if the server is running Windows<sup>®</sup> operating system, it would be best to use the Generic profile.

To change settings in the BIOS menu or boot from a virtual media drive, depending on the target server model, a BIOS profile may be more appropriate.

If none of the standard USB profiles provided by Raritan work with a provided target server, contact Raritan Technical Support for assistance.

For detailed information of each USB profile, see the section titled "Available USB Profiles" in the user documentation of the KX III KVM switch, which is accessible from the KVM switch application or the Raritan website's **Support page** (<http://www.raritan.com/support/>).

---

## Virtual Media

The Dominion User Station supports virtual media (VM). Virtual media extends KVM capabilities by enabling target servers to remotely access media from the User Station and network file servers.

With this feature, media mounted on the User Station and network file servers are essentially "mounted virtually" by the target server. The target server can then read from and write to that media as if it were physically connected to the target server itself.

Virtual media sessions are secured using 128 or 256 bit AES encryption. Up to two virtual media drives of different types are supported.

Virtual media provides the ability to perform tasks remotely, such as:

- Transferring files
- Running diagnostics
- Installing or patching applications
- Complete installation of the operating system
- Record and playback of digital audio

---

**Important: Once you are connected to a virtual media drive, do not change mouse modes in the KVM client if you are performing file transfers, upgrades, installations or other similar actions. Doing so may cause errors on the virtual media drive or cause the virtual media drive to fail.**

---

For the VM types supported by the Dominion User Station, see **Supported Virtual Media Types** (on page 64).

### Prerequisites for Using Virtual Media

▶ **KVM switch requirements:**

- If you want to access virtual media, your "KVM switch" permissions must be set to allow access to the relevant KVM ports, as well as virtual media access (VM Access port permission) for those ports.

KVM switch permissions are determined according to the user credentials you entered for the KVM switches. See **Editing KVM Switches** (on page 30).

- A USB connection through the virtual media CIM must exist between the KVM switch and the target server.
- ▶ **Target server requirements:**
  - You must choose the correct USB profile for the target server. See **USB Settings** (on page 61).
  - KVM target servers must support USB connected drives.
  - USB 2.0 ports are faster and preferred.
- ▶ **CIM requirements:**
  - A virtual media CIM is required on the target server. See **Virtual Media CIMs** (on page 68).

#### Supported Virtual Media Types

- External hard drives
- USB-mounted CD/DVD drives
- USB mass storage devices
- ISO images (disk images)  
ISO9660 is the standard supported by Raritan. However, other ISO standards can be used.

---

*Note: Connecting digital audio devices onto the target server is also supported. See **Audio** (on page 69).*

---

#### Mounting Local Drives

This option mounts an entire disk drive virtually onto the target server.

Use this option for external drives only. It does not include network drives, CD-ROM, or DVD-ROM drives.

#### ▶ To mount a local drive:

1. Click  to open the "USB Settings and Devices" dialog.

- Click the "Virtual Media" button. The Map Virtual Media Drive dialog appears.

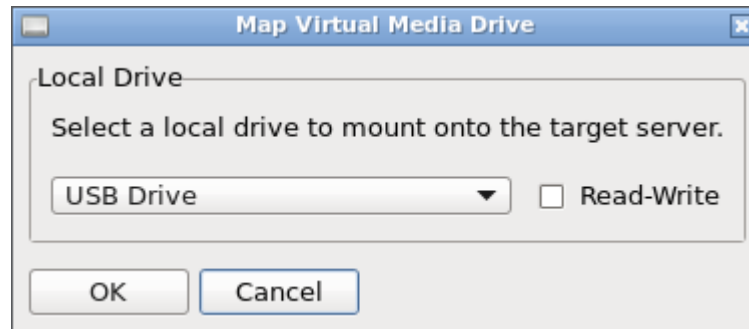

- Choose the drive from the Local Drive drop-down list.
- If you want Read and Write capabilities, select the Read-Write checkbox.
  - This option is not configurable in some scenarios. See **Scenarios When Read/Write is Unavailable** (on page 65).
  - When selected, you will be able to read or write to the connected USB drive.

---

*WARNING: Enabling Read/Write access can be dangerous! Simultaneous access to the same drive from more than one entity can result in data corruption. If you do not require Write access, leave this option unselected.*

---

- Click OK.

The media will be mounted on the target server virtually. You can access the media just like any other drive.

#### **Scenarios When Read/Write is Unavailable**

Virtual media Read/Write is not available in the following situations:

- The drive is write-protected
- The user credentials you entered for the KVM switch does not have Read/Write permission on the KVM port you are accessing.

For information on how to enter user credentials for KVM switches, see **Editing KVM Switches** (on page 30).

For the difference between the User Station's user credentials and a KVM switch's user credentials, see **Authentication of User Stations and KVM Switches** (on page 133).

### Mounting CD-ROM/DVD-ROM/ISO Images

ISO9660 format is the standard supported by Raritan. However, other CD-ROM extensions may also work.

---

*Note: Audio CDs are not supported by virtual media so they do not work with the audio feature.*

---

► **To mount a CD-ROM , DVD-ROM or ISO image:**

1. Click **USB** to open the "USB Settings and Devices" dialog.
2. Click the "CD-ROM/ISO..." button. The Map CD-ROM Drive / ISO Image dialog appears.

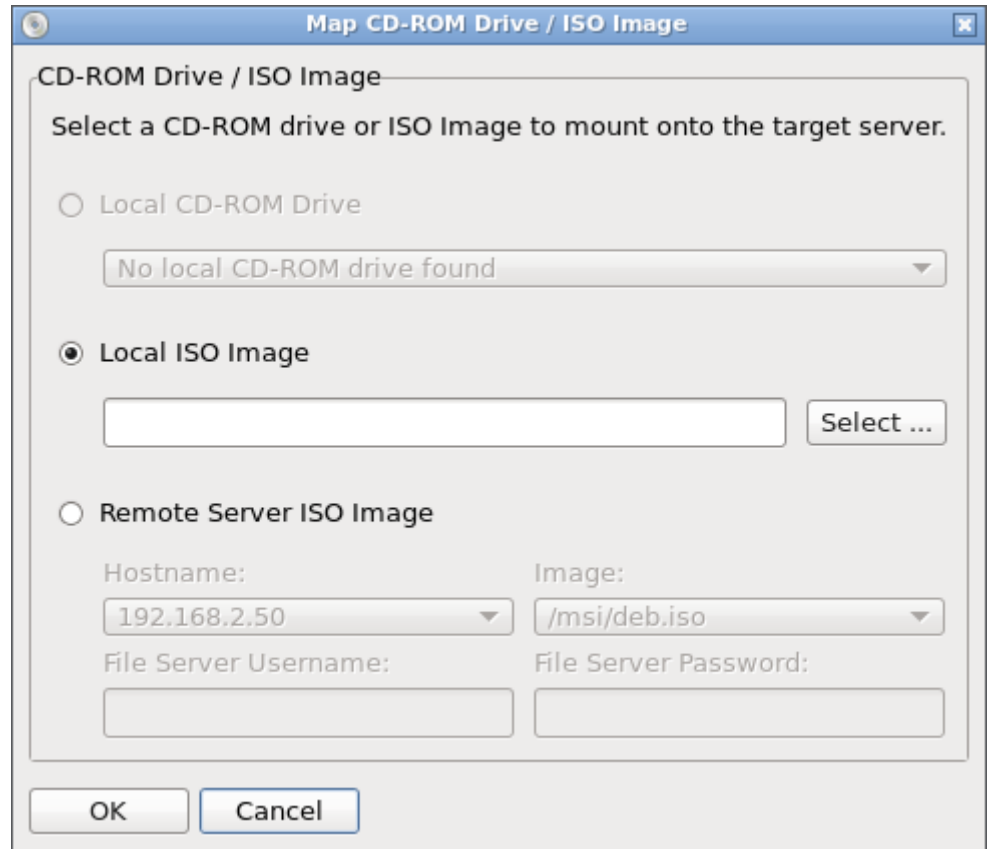

3. For USB CD-ROM/DVD-ROM drives:
  - a. Select the Local CD-ROM Drive option.
  - b. Choose the drive from the Local CD-ROM Drive drop-down list, which shows all available CD-ROM/DVD-ROM drive names.
4. For ISO images:



- a. Select the Local ISO Image option. Use this option when you want to access a disk image of a CD-ROM or hard drive. ISO format is the only format supported.
  - b. Click Browse to navigate to the path containing the disk image you want to use.
5. For remote ISO images on a file server:
- a. Select the Remote Server ISO Image option.
  - b. Select Hostname and Image from the drop-down list.  
The hostnames (file servers) and image paths available in the list are those that you configured using the KX III KVM switch's File Server Setup page. See the KVM switch's user documentation for further information.
  - c. File Server Username - User name required for access to the file server. The name can include the domain name such as mydomain/username.
  - d. File Server Password - Password required for access to the file server (field is masked as you type).
6. Click OK.

The media will be mounted on the target server virtually. You can access the media just like any other drive.

---

*Note: If you are working with files on a Linux® target server, use the Linux Sync command after the files are copied using virtual media in order to view the copied files. Files may not appear until a sync is performed.*

---

### Disconnecting from a Virtual Media Drive

When the KVM Client is closed, the virtual media is closed.

You can also use the Disconnect button without closing the current KVM Client.

---

**Important: It is highly recommended to first "safely remove" or "eject" the virtual media drive that you want to disconnect from the target server. If you have enabled the read/write mode, it will result in data loss when you do not perform this operation. Refer to the user documentation of the target server's operating system for how to "safely remove" or "eject" a drive.**

---

#### ► To disconnect the virtual media drives:

1. Click  to open the "USB Settings and Devices" dialog.  
Existing virtual media devices are listed at the bottom of the dialog.
2. Click the Disconnect button for the one you want to disconnect.

3. Click Yes on the confirmation message.

#### **Virtual Media CIMs**

It requires the use of the following virtual media (VM) CIMs on the target servers you are accessing.

- D2CIM-VUSB
- D2CIM-DVUSB
- D2CIM-DVUSB-DVI
- D2CIM-DVUSB-HDMI
- D2CIM-DVUSB-DP

The black USB connector on the DVUSB CIMs are used for the keyboard and mouse. The gray connector is used for virtual media.

**Keep both USB plugs of the CIM connected to the device.**

The device may not operate properly if both plugs are not connected to the target server.

#### **Number of Supported Virtual Media Drives**

With the virtual media feature, you can mount up to two drives (of different types) that are supported by the USB profile currently applied to the target server. These drives are accessible for the duration of the KVM session.

For example, you can mount a specific CD-ROM, use it, and then physically disconnect it when you are done. The CD-ROM virtual media “channel” will remain open, however, so that you can virtually mount another CD-ROM. These virtual media “channels” remain open until the KVM session is closed as long as the USB profile supports it.

To use virtual media, connect/attach the media to the User Station or network file server that you want to access from the target server.

This needs not be the first step, but it must be done prior to attempting to access this media.

---

## Audio

The User Station supports end-to-end, bidirectional, digital audio connections with a target server for digital audio playback and capture devices.

One of the following CIMs must be used:

- D2CIM-DVUSB
- D2CIM-DVUSB-DVI
- D2CIM-DVUSB-HDMI
- D2CIM-DVUSB-DP

There are two methods to connect audio devices to a specific target server:

- Always automatically establish the audio connection when accessing this target server. See **Configuring KVM Ports** (on page 31).
- Manually establish an audio connection using the KVM Client toolbar. See **Connecting Audio Devices** (on page 69).

### Connecting Audio Devices

If an audio device is connected to the User Station, you can connect it to the target server.

---

*Note: Prior to connecting the audio devices to the target server, you may have to specify the audio devices you want to use. Per default, the front-panel analog speakers and microphone are used. See **Audio Settings** (on page 78).*

---

#### ► To connect an audio device to the target server:

1. Click **USB** to open the "USB Settings and Devices" dialog.
2. Click the Audio button. The Connect Audio Device dialog appears.



- Connect Playback Device: This option connects an available audio playback device, such as a speaker or headphones, to the target server.
  - Connect Capture Device: This option connects an available audio capture device, such as a microphone, to the target server.
3. Click OK.

---

## Power Control

You can power on, power off, and power cycle a target server through the outlet it is connected to.

This power control button is enabled only when the power control requirements are met.

▶ **Power control requirements:**

- On the KX III KVM switch, a PDU's outlet must be associated with the selected KVM port.
- The user credentials you entered for the KVM switch grant you the power control permission.

See the KVM switch's user documentation for more information.

▶ **To power on, off or power cycle the target server:**

1. Click  to select a power control option.
  - Power On: Turns ON the server.
  - Power Off: Turns OFF the server.
  - Power Cycle: Turns OFF and then turns ON the server.

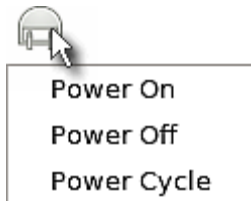

- Click Yes on the confirmation message.

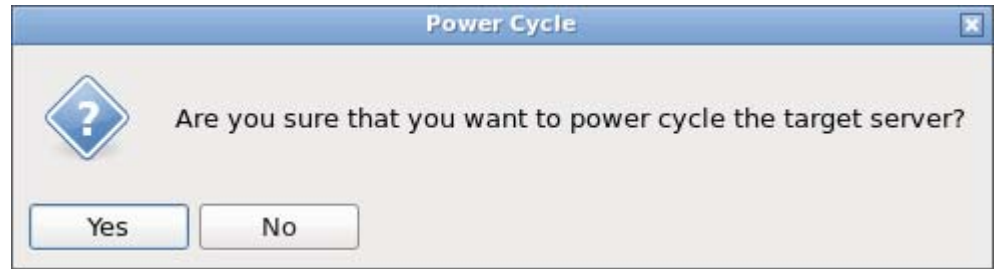

---

## View Settings

Click  to show available view options.

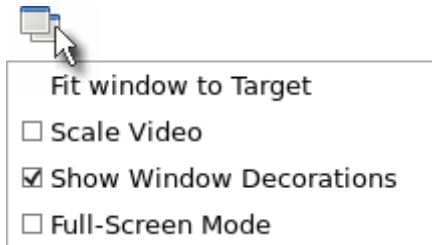



---

### Fit window to Target

The "Fit window to Target" command enlarges or shrinks the size of the KVM Client window to the target server's video resolution.

The KVM Client's scroll bars may or may not appear, depending on whether the target server's resolution is small enough for the KVM Client window to show the target server's entire desktop video.

► **To fit the KVM Client window to the target server:**

- Click  > Fit window to Target.
- OR click .

---

### Scale Video

Selecting the Scale Video checkbox increases or reduces the size of the target server's video to fit the KVM Client window size.

This feature maintains the aspect ratio so that you see the entire target server's desktop without using the scroll bars.

---

*Tip: You can have this display option automatically enabled or disabled by setting your preferences on the KVM Client Settings page. See **KVM Client Settings** (on page 79).*

---

▶ **To toggle video scaling:**

- Click  > Scale Video.

---

### Show Window Decorations

You can use the KVM Client with or without the window decorations, including the window title and scroll bars.

---

*Tip: You can have this display option automatically enabled or disabled by setting your preferences on the KVM Client Settings page. See **KVM Client Settings** (on page 79).*

---

▶ **To toggle the display of the window decorations:**

- Click  > Show Window Decorations.

---

### Full Screen Mode

When you enter the full screen mode, the target server's video displays in the full screen and acquires the same resolution as the target server.



In the full screen mode, the KVM Client's scroll bars are invisible, and its toolbar displays for several seconds only before disappearing from the screen.

▶ **To enter full screen mode:**

1. Click  > Full Screen Mode, or click .

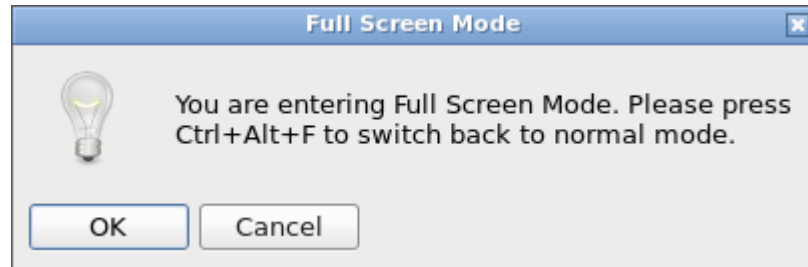
2. Click OK on the confirmation message.



- ▶ **To display the toolbar in this mode:**
  - Move your mouse to the top of the screen.
- ▶ **To exit full screen mode:**
  - Press Ctrl+Alt+F on your keyboard.
  - OR click  in the toolbar.
  - OR click  > Full Screen Mode.

# Chapter 6 Setting User Preferences

In the User Station Configuration window, click Preferences to customize the following user settings.

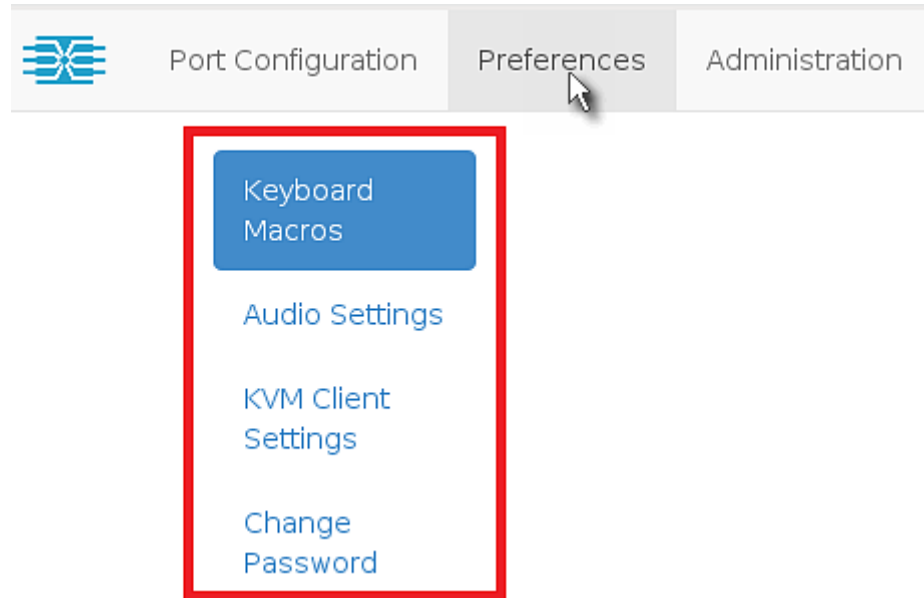

## In This Chapter

Keyboard Macros .....	74
Audio Settings .....	78
KVM Client Settings.....	79
Password Change .....	80

---

## Keyboard Macros

Keyboard macros ensure that keystroke combinations intended for the target server are sent to and interpreted only by the target server. Otherwise, they might be interpreted by the User Station itself.

Keyboard macros are stored on the User Station, and only the user who created them can see and use these macros.

► **To create a keyboard/hot key macro:**

1. If not displayed, launch the User Station Configuration window. See **User Station Configuration** (on page 27).



2. Click Preferences > Keyboard Macros > . The New Keyboard Macro page opens.

## New Keyboard Macro

Enabled

\* **Name**

\_\_\_\_\_

\* **Sequence**

Key Sets: All Keys

Keys:

- Left Ctrl
- Right Ctrl
- Left Alt
- Right Alt
- Left Shift
- Right Shift
- Scroll Lock
- Caps Lock
- Num Lock
- Left Windows Key

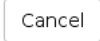
3. Enter information for the new keyboard macro. The fields marked with the symbol \* are mandatory.

Field/option	Description
Enabled	Select this checkbox so that the new macro can appear in the KVM Client of this User Station. See <b><i>Executing Macros</i></b> (on page 76).
Name	Type a name for the new macro.
Key Sets	Select the key set containing the desired keys. See <b><i>Available Key Sets</i></b> (on page 135).  All keys that the selected key set contains are listed in the Keys box.

Field/option	Description
Keys	<p>Select each desired key from the list and click ► to add it to the right box.</p> <ul style="list-style-type: none"> <li>▪ Select the keys in the order by which they are to be pressed.</li> <li>▪ A Release key command is automatically added for each key added to the right box. See <b>Keyboard Macro Example</b> (on page 77).</li> </ul>

- If needed, make changes to the keys shown in the right box.
  - To resort the key commands, select a key command and click ▲ or ▼ to move it up or down.
  - To remove a key command, select it and click ◀.
- Click Save, and the new macro's content is shown.
- Click one of these buttons according to your needs.
  - Back: Return to the Keyboard Macro page.
  - Edit: Modify this macro's content.
  - Delete: Remove this macro.

### Executing Macros

Manually-created keyboard macros, if they are enabled, appear following the pre-programmed keyboard macros in the keyboard pull-down list of the KVM Client. See **Using the KVM Client** (on page 45).

Click  to show the keyboard macro list, and select the desired macro to send it to the target server.

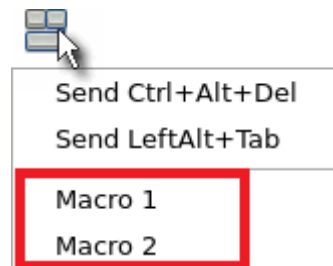

## Editing or Deleting Macros

To view all manually-created keyboard macros in the User Station Configuration window, click Preferences > Keyboard Macros.

# Keyboard Macros

[New Macro](#)

Enabled	Name	
<input checked="" type="checkbox"/>	Macro 1	<a href="#">Edit</a> <a href="#">Delete</a>
<input checked="" type="checkbox"/>	Macro 2	<a href="#">Edit</a> <a href="#">Delete</a>
<input type="checkbox"/>	Macro 3	<a href="#">Edit</a> <a href="#">Delete</a>

- An enabled macro shows  in the Enabled column.
- A disabled macro shows  in the Enabled column.

### ▶ To edit a keyboard macro:

1. Click the desired macro's [Edit](#) button.
2. Make necessary changes to the information shown. See **Keyboard Macros** (on page 74).

### ▶ To delete a keyboard macro:

1. Click the desired macro's [Delete](#) button.
2. Click OK on the confirmation message.

## Keyboard Macro Example

For example, you can create a keyboard macro to close a window by selecting `Left Alt+F4+Esc`.

The macro's content looks like the following.

```
Press Left Alt
Press F4
Press ESC
Release F4
Release ESC
Release Left Alt
```

---

## Audio Settings

The default audio playback/capture devices used by the User Station are the front-panel analog speakers and microphone.

You can change this by setting other audio devices you prefer as the audio playback and/or capture devices.

---

*Note:* To change additional audio configuration, see **Sound Preferences** (on page 120).

---

► **To determine the audio appliances used by the User Station:**

1. If not displayed, launch the User Station Configuration window. See **User Station Configuration** (on page 27).
2. Click Preferences > Audio Settings. The Audio Devices page opens, indicating the current audio playback and capture devices being used.

## Audio Devices

You can change the audio devices used by the KVM client by setting the devices you prefer as the speaker and/or microphone. The default audio devices used by the User Station KVM Client are the front-panel analog speakers and microphone.

**Note:** This setting is shared between all your KVM sessions.

**Speaker:** Built-in, Analog  
**Microphone:** Built-in, Analog

Edit

3. Click Edit, if intending to make changes.
4. In the Speaker field, select the audio playback device you prefer.
  - The currently selected audio device is marked with the word "active" in parentheses.
5. In the Microphone field, select the audio capture device you prefer.
6. Click Save.

## KVM Client Settings

You can configure the preferred positioning and display settings that always apply to the KVM Client window when it opens.

► **To determine your KVM Client preferences:**

1. If not displayed, launch the User Station Configuration window. See **User Station Configuration** (on page 27).
2. Click Preferences > KVM Client Settings. The KVM Client Settings page opens, showing the current preferences.
  - indicates the setting is enabled.
  - indicates the setting is disabled.

## KVM Client Settings

You can change the preferred positioning and display options of the KVM Client here. Please select the position on the screen where you want to open KVM sessions, select whether you want to have scaling applied automatically and whether you want to see window decorations or not.

**Note:** These settings don't apply to already active KVM sessions.

Positioning: Disabled  
 Scale Video:   
 Window Decorations:

Edit

3. Click Edit, if intending to make changes.
4. In the Positioning field, determine the position where the KVM Client shows up on the screen.

Position	Description
Disabled	The positioning of the KVM Client is not restricted.  For example, the first KVM Client that appears may align with the top-left corner of the screen, but the second KVM Client may align with the bottom-right corner of the screen.
Left Upper Corner	Every KVM Client aligns with the top-left corner of the screen.
Right Upper Corner	Every KVM Client aligns with the top-right corner of the screen.

- Determine the display settings that automatically apply to the KVM Client.

Checkbox	Description
Scale Video	Enable or disable the Scale Video function. For details on Scale Video, see <b>Scale Video</b> (on page 72).
Window Decorations	Show or hide the window decorations. For details on window decorations, see <b>Show Window Decorations</b> (on page 72).

- Click Save.

---

## Password Change

You can change your own password.

► **To change your password:**

- If not displayed, launch the User Station Configuration window. See **User Station Configuration** (on page 27).
- Click Preferences > Password Change. You are directed to the Edit User page, where you can enter new password. See **Editing or Deleting Users** (on page 84).
- Click Save.

## Chapter 7 Administration Features

In the User Station Configuration window, click Administration to perform the following User Station administration tasks.

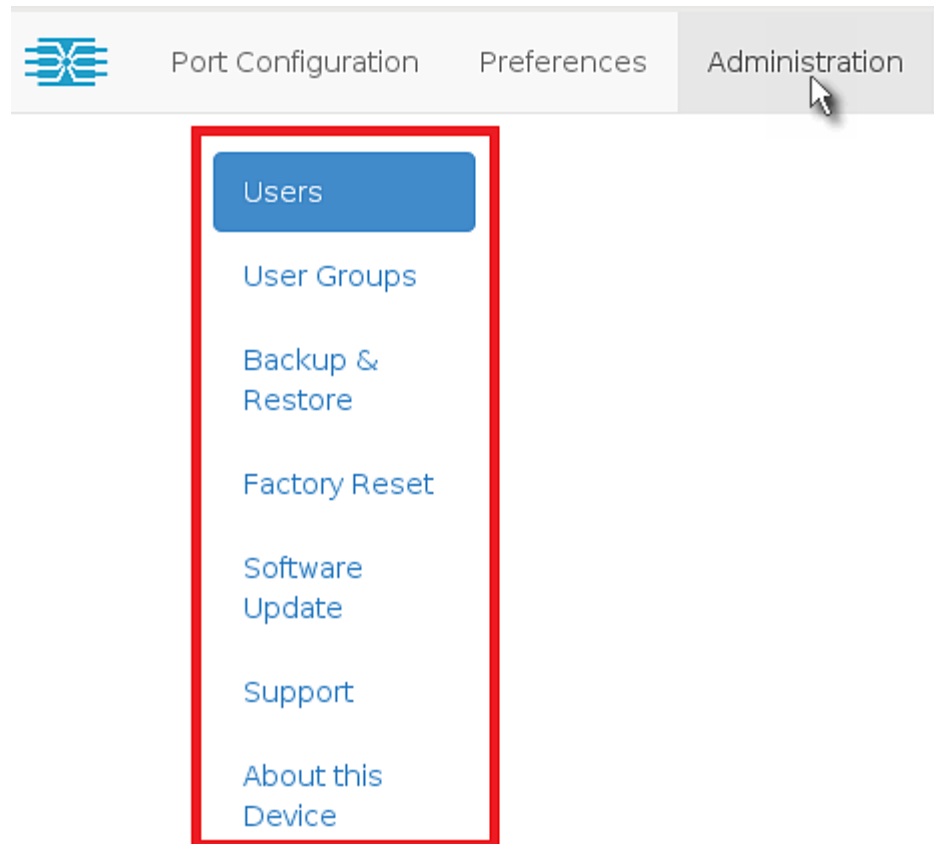

### In This Chapter

Users .....	82
User Groups .....	85
Backup and Restore .....	89
Factory Reset .....	92
Software Update .....	94
Support .....	95
About this Device .....	96

## Users

The Dominion User Station provides a built-in administrator account, which is ideal for initial login and system administration.

User name	Privileges
admin	<ul style="list-style-type: none"> <li>▪ System Administration.</li> <li>▪ Device Administration.</li> <li>▪ Device Access.</li> </ul> <p>See <b>Privileges</b> (on page 87).</p>

You can add user profiles with configurable privileges for other users to operate and administer the User Station.

Note that the Dominion User Station's user profiles determine the permissions users are granted to have on the User Station instead of the KVM switches. See **Authentication of User Stations and KVM Switches** (on page 133).

► **To create a user profile:**

1. If not displayed, launch the User Station Configuration window. See **User Station Configuration** (on page 27).



- Click Administration > Users > . The New User page opens.

## New User

**\* Login**

**Name**

**Email**

**\* Password**

**\* Password confirmation**

**\* Selected User Groups**

<<

<

>

>>

System Administrators

Devices Administrator

Devices Users

- Enter information for the new user. The fields marked with \* are mandatory.

Field	Description
Login	User name for logging in to the User Station.
Name	Real name or nickname of the user.
Email	The email address to reach the user.
Password, Password confirmation	Password for logging in to the User Station. A minimum of five characters are required.

Field	Description
Selected User Groups	<p>Assigning user groups determines the permissions granted to this user. See <b>User Groups</b> (on page 85).</p> <ul style="list-style-type: none"> <li>To select all available user groups, click &lt;&lt;.</li> <li>To select one user group, select it in the Available User Groups box, and click &lt;.</li> <li>To remove one user group from the Selected User Groups box, select it, and click &gt;.</li> <li>To remove all user groups in the Selected User Groups box, click &gt;&gt;.</li> </ul>

- Click Save, and the new user profile's content is shown.
- Click one of these buttons according to your needs.
  - Back: Return to the Users page.
  - Edit: Modify this user profile's data.
  - Delete: Remove this user profile.

### Editing or Deleting Users

To view all user profiles in the User Station Configuration window, click Administration > Users.

## Users

[New User](#)

Login name	Name	Email	Privileges	User Groups	Actions
admin	Administrator		System Administration Device Administration Device Access		<a href="#">Edit</a>
User-1	John	john@xxx.com	Device Access	Devices Users	<a href="#">Edit</a> <a href="#">Delete</a>
User-2	Mary	mary@xxx.com	Device Administration Device Access	Devices Administrators Devices Users	<a href="#">Edit</a> <a href="#">Delete</a>

The Privileges column indicates the permissions granted to each user. Privileges are determined based on the user groups assigned to each user. See **User Groups** (on page 85).

Each user profile shows a maximum of five user groups. If there are more than five user groups for a user profile, it shows a message below the fifth user group -- "... and <n> more" , where <n> is the number of additional user groups.

You can click each user's login name to view its details.

Note that you cannot delete the built-in *admin* user, but you can modify its data other than the privileges.

► **To modify a user profile:**

1. Click the desired user's  button. The Edit User page opens.
2. Make necessary changes to the information shown. See **Users** (on page 82).
  - You cannot change the login name.
  - To change the user's password, type the new password in the "Password" and "Password confirmation" fields. A minimum of five characters are required.
3. Click Save.

► **To delete a user profile:**

1. Click the desired user's  button.
2. Click OK on the confirmation message.

---

## User Groups

A user group determines the privileges its members can have.

There are three factory default user groups.

User groups	Default privileges
System Administrators	System Administration. See <b>Privileges</b> (on page 87).
Device Administrators	Device Administration. Device Access.
Device Users	Device Access.

You can create a new user group if the default user groups do not satisfy your needs.

► **To create a new user group:**

1. If not displayed, launch the User Station Configuration window. See **User Station Configuration** (on page 27).

2. Click Administration > User Groups > . The New User Group page opens.

# New User Group

**\* Name**

**\* Privileges**

- Device Access
- Device Administration
- System Administration

3. Enter information for the new user group.

Field	Description
Name	Type a name for the new user group.
Privileges	Assign one or multiple privileges to the new user group. See <b>Privileges</b> (on page 87).

4. Click Save, and the new user group's data is shown.
5. Click one of these buttons according to your needs.
  - Back: Return to the User Groups page.
  - Edit: Modify this user group's data.
  - Delete: Remove this user group.

## Privileges

Privilege	Operations permitted
System Administration	All operations on the User Station are permitted.
Device Administration	<ul style="list-style-type: none"> <li>▪ Log in to the User Station.</li> <li>▪ Modify personal settings.</li> <li>▪ Access a KVM port.</li> <li>▪ Add, delete and modify the data of KX III KVM switches.</li> <li>▪ Configure KVM ports.</li> <li>▪ Back up the User Station's settings.</li> </ul>
Device Access	<ul style="list-style-type: none"> <li>▪ Log in to the User Station.</li> <li>▪ Modify personal settings.</li> <li>▪ Access a KVM port.</li> <li>▪ Configure KVM ports.</li> </ul>

*Note: "Device Administration" is NOT allowed to delete, export or import backup files, or restore the User Station's settings. Only "System Administration" can perform these tasks.*

## Editing or Deleting User Groups

To view all user groups in the User Station Configuration window, click Administration > User Groups.

## User Groups

[New User Group](#)

Name	Privileges	Users	Actions
<a href="#">System Administrators</a>	System Administration	Alan	<a href="#">Edit</a> <a href="#">Delete</a>
<a href="#">Devices Administrators</a>	Device Administration Device Access	Mary Summer	<a href="#">Edit</a> <a href="#">Delete</a>
<a href="#">Devices Users</a>	Device Access	John Mary Daniel	<a href="#">Edit</a> <a href="#">Delete</a>

The Users column lists the names of all users who belong to this user group. The priority is to show the real names of these users. If the real name is not available in the user profile, the user's login name is shown. See **Users** (on page 82).

Each user group shows a maximum of five users. If a user group contains more than five users, it shows a message below the fifth user -- "... and <n> more" , where <n> is the number of additional users.

You can click each user group's name to view its details.

You can delete any user group no matter it contains users or not.

► **To modify a user group:**

1. Click the desired user group's  button.
2. Make necessary changes to the information shown. See **User Groups** (on page 85).
3. Click Save.

► **To delete a user group:**

1. Click the desired user group's  button.
2. A confirmation message appears.
  - If any user will not be able to log in after losing this user group, the confirmation message shows a warning similar to the following diagram. This is because the selected user group is the only user group that one or some of the group members have.

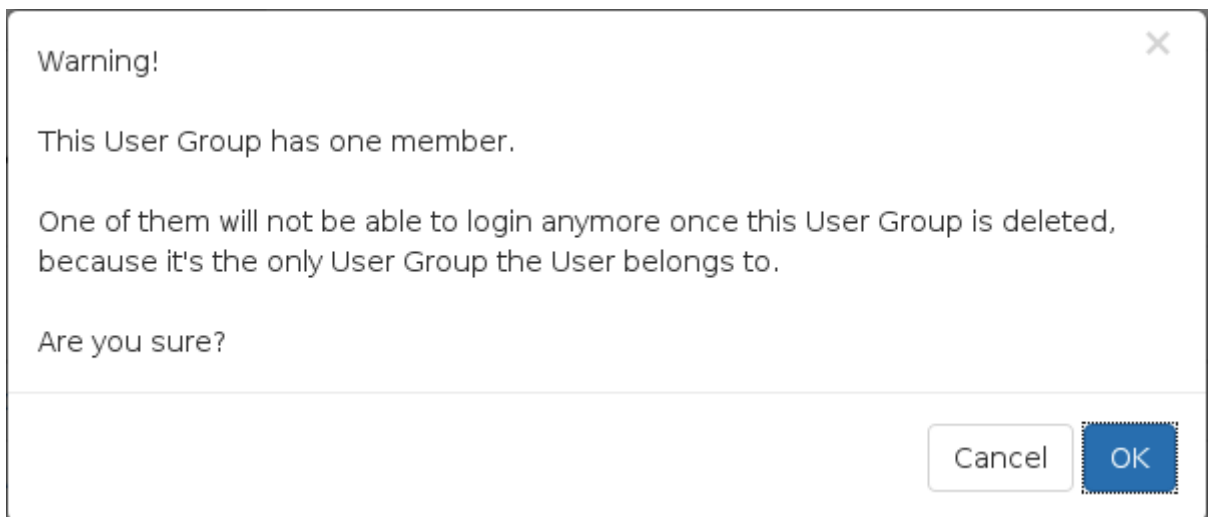

3. Click OK to confirm the deletion or Cancel to abort it.

## Backup and Restore

The User Station allows you to easily back up the latest settings and data with only one click. By default, the backup files are stored in the User Station's hard disk drive.

In case you have to restore to the previous settings and data, select the backup file you need and perform the restore command.

---

*Tip: You can export or import backup files from a FAT-/FAT32-formatted USB flash drive. See **Exporting and Importing Backup Files** (on page 90).*

---

► **To back up the current settings and data:**

1. If not displayed, launch the User Station Configuration window. See **User Station Configuration** (on page 27).
2. Click Administration > Backup & Restore. The Backup Archives page opens.

## Backup Archives

Create an Archive

No backup archives have been created yet.

## Import Archive from USB Drive

No backup archives found for import.

### Attention

A backup archive can be created with the "Create an Archive" button. An archive can be restored and deleted. After successful restore you will be logged out and need to re-login to User Station to continue.

Furthermore an archive can be exported to an USB flash drive as well as imported from an USB flash drive. To use the backup archive export/import a FAT/FAT32 formatted USB flash drive must be connected to User Station.

Create an Archive





3. Click .
4. Once completed, the Backup Archives page lists the backup file, with the filename, software version and file size shown on the screen.

► **To restore to the previous settings and data:**

1. If there are any existing backup files, the Backup Archives page lists all of them.

## Backup Archives

Create an Archive

Filename	Version	Size	Actions
<a href="#">KX3UST_backup_1.0.0.5.310_20151104052311.dat</a>	1.0.0.5.310	12 KB	 
<a href="#">KX3UST_backup_1.0.0.5.310_20151108222101.dat</a>	1.0.0.5.310	13.1 KB	 

2. Select the desired file, and click its  button.

---

*Note: The other button is used to delete the backup file. See **Deleting Backup Files** (on page 91).*

---

3. Click OK on the confirmation message.
4. A message similar to the following appears when the restore completes successfully.

**Archive:** KX3UST\_backup\_1.0.0.5.310\_20151108222101.dat

**Status:**  Restore successfully finished. You will be logged out shortly...

5. The User Station logs you out after seven seconds.

---

### Exporting and Importing Backup Files

To export or import a backup file, you must connect a USB flash drive to the User Station first.

► **To export backup files:**







1. Connect a FAT-/FAT32-formatted USB drive.



- Click Administration > Backup & Restore. The Backup Archives page opens. When the User Station detects the connected USB drive, the export button  appears in the Actions column.

## Backup Archives

[Create an Archive](#)



Filename	Version	Size	Actions
<a href="#">KX3UST_backup_1.0.0.5.310_20151104052311.dat</a>	1.0.0.5.310	12 KB	  
<a href="#">KX3UST_backup_1.0.0.5.310_20151108222101.dat</a>	1.0.0.5.310	13.1 KB	  

- Click the  button of the desired backup file.  
The selected file is exported to the connected USB drive and therefore listed in the "Import Archive from USB Drive" section.
- Repeat the same steps if intending to export additional backup files.

### ▶ To import backup files:

- Make sure the connected USB drive contains backup files in its *root* directory.
- The Backup Archives page shows all backup files it detects in the USB drive in the "Import Archive from USB Drive" section.

## Import Archive from USB Drive

USB Drive	Filename	Size	Actions
ACE2-E4E4	<a href="#">KX3UST_backup_1.0.0.5.282_20151015131036.dat</a>	5.95 KB	
ACE2-E4E4	<a href="#">KX3UST_backup_1.0.0.5.282_20151016101920.dat</a>	6.03 KB	

- Click the  button of the desired backup file.  
The selected file is imported from the connected USB drive, and thus shown in the Backup Archives section.
- Repeat the same steps if intending to import additional backup files.

### Deleting Backup Files

It is better to check the creation date of a backup file before removing it.

The creation date is the first 8 digits following the software version number in the filename. For example, if the filename is:

`KX3UST_backup_1.0.0.5.284_20151014090046.dat`

Its software version is 1.0.0.5.284, so its date is 20151014, which is October 14, 2015.

► **To remove a backup file:**

1. To show existing backup files, click Administration > Backup & Restore.
2. Click the  button of the desired file.
3. Click OK on the confirmation message.

---

## Factory Reset

The factory reset feature resets all of your User Station's settings to the factory defaults, but it will remove all customized data simultaneously, including:

- All KVM switches added to the User Station
- User credentials entered for each KVM switch
- User profiles other than the *admin* user
- User groups other than the built-in user groups
- All user preferences settings, such as keyboard macros
- Backup files

► **To perform the factory reset:**

1. If not displayed, launch the User Station Configuration window. See ***User Station Configuration*** (on page 27).

2. Click Administration > Factory Reset. The factory reset page opens. Read this page before proceeding to the next step.

## Reset to Factory Defaults

### Attention

This function will erase all data from your User Station's storage, including:

- Dominion KX Devices
- Credentials to access KX Devices
- Users and User Groups
- User Preferences
- Backup Files
- Log Files

You will be logged out and the system will reboot while the reset is executed. Afterwards you can login as user **admin**.

 Perform Factory Reset

3. Click  Perform Factory Reset.
4. Click OK to confirm the operation or Cancel to abort it.

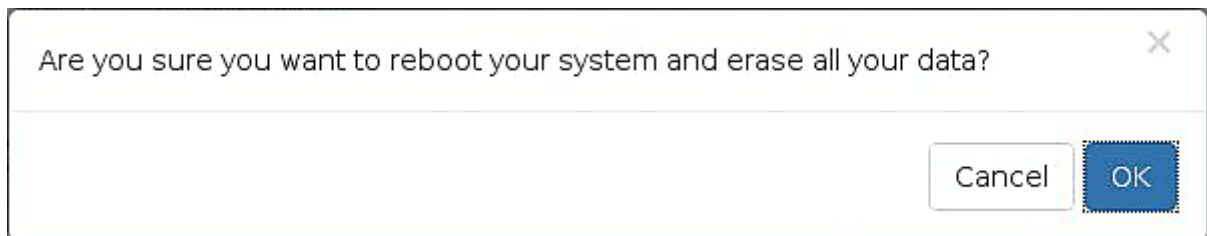

---

## Software Update

The software update feature only permits software UPGRADE, not downgrade.

---

*Note: To perform software downgrade, contact Raritan Technical Support for help.*

---

To perform the software update, you must meet the following requirements:

- Your User Station has been installed with the User Station software, and the software runs properly.

---

*Note: If your User Station cannot run the software properly, for example, the login screen is not shown after being powered on, contact Raritan Technical Support for software update.*

---

- You have a FAT32-formatted USB flash drive.
- The version of the software which you will install is equal to or higher than the software version currently installed on your User Station. See **About this Device** (on page 96).

---

**Important: It is strongly recommended to back up all data and settings prior to the software update. See *Backup and Restore* (on page 89).**

---

► **To perform the software UPGRADE:**

1. Use a computer to download the User Station software file from the Dominion KX III section of the Raritan website's **Support page** (<http://www.raritan.com/support/>).
2. Copy the file named "KX3UST\_<version>\_update.bin" to the **root directory** of your USB flash drive. Make sure there is sufficient room in the USB drive.
  - <version> in the filename refers to the software's version number.
3. On the User Station, log in as a user who has the System Administration privilege.
4. Plug the USB drive containing the software file into any USB port on the User Station.
5. Launch the User Station Configuration window. See **User Station Configuration** (on page 27).
6. Click Administration > Software Update. The Software Updates page opens, with a list of software files found in the root directory of the connected USB drive.

---

*Note: If desired software files are NOT detected, click Rescan USB to re-scan all connected USB drives.*

---

## Software Updates



Storage	Update File	Size
ACE2-E4E4	<a href="#">KX3UST_1.0.0.5.350_update.bin</a>	106 MB
	<a href="#">KX3UST_1.0.0.5.330_update.bin</a>	106 MB
	<a href="#">KX3UST_1.0.0.5.320_update.bin</a>	106 MB

### Attention

In order to update the software of your system insert an USB-Storage, such as an USB-Stick, containing the Update File in its root directory. You can examine an

- Click the desired file, and it will be analyzed. View the details carefully, including the minimum required version and validity check results.



- Click  to perform the software upgrade.

---

*Warning: Do NOT power off the User Station during the software upgrade.*

---

- Click OK on the confirmation message.
- When the upgrade completes, the User Station reboots, and then the login screen is shown.

---

*Note: In case the software upgrade fails, and the User Station is unable to operate, contact Raritan Technical Support.*

---

## Support

The User Station provides a Support Login feature, which allows remote access from Raritan Technical Support for helping troubleshoot your User Station issues.

By default, the Support Login feature is disabled for security.

You **MUST NOT** enable this feature unless you are instructed by Raritan Technical Support to do so.

### ► To permit remote access from Raritan Technical Support:

- If not displayed, launch the User Station Configuration window. See **User Station Configuration** (on page 27).
- Click Administration > Support. The Support Settings page opens.
  - indicates the setting is enabled.

- indicates the setting is disabled.

## Support Settings

Support Login:  is disabled

The Support Login may be used to examine the system in case of problems. Under normal circumstances it must be disabled!

Edit

3. Click Edit.
4. Select the Enable Support Login checkbox.
5. Click **Update Support Settings**.
6. Provide your User Station's IP address to Raritan Technical Support.
  - To retrieve the IP address(es), right-click the network icon in the Main Toolbar to select Connection Information. See **Network Icon** (on page 123).

---

**Important: Disable this feature immediately after Raritan Technical Support finishes the troubleshooting task.**

---

### About this Device

The "About this Device" page shows the firmware version information. You can access this page either via the Main Menu or via the User Station Configuration window.

► **To show the version in the User Station Configuration window:**

1. If not displayed, launch the User Station Configuration window. See **User Station Configuration** (on page 27).

- Click Administration > About this Device. The version information page opens.

## Dominion KX III User Station

An appliance built for speed and simplicity in accessing Dominion KX III.

Version: 1.0.0.5.XXX

**Open Source License Notification**

Raritan, Inc. (Raritan) uses Open Source software in some of its products, including software licensed under the GNU General Public License ("GPL"). Most open source packages are used unmodified as binaries, but where required, Raritan has modified the open source package to perform the functions required for the Raritan products. Raritan makes the open source software and any modifications available consistent with the terms of the GPL and LGPL regardless of whether those licenses apply. The code made available by Raritan is for informational purposes only and distributed "As is" with no support and/or warranty of any kind intended, implied, or provided.

For more information, please go to <http://www.raritan.com/about-us/legal/open-source-software-statement>.

Copyright © 2015 Raritan, Inc.

► **To show the version via the Main Menu:**

- Choose Main Menu > Help > About this Device.

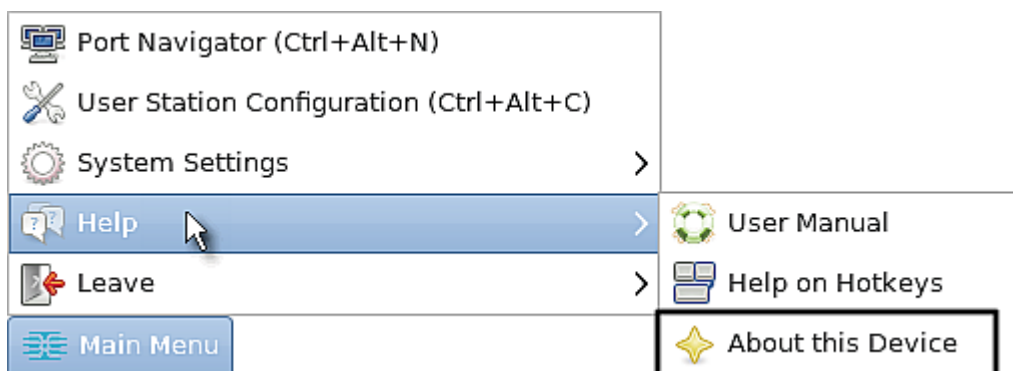

# Chapter 8 System Settings

Most of the system settings are available under System Settings in the Main Menu.

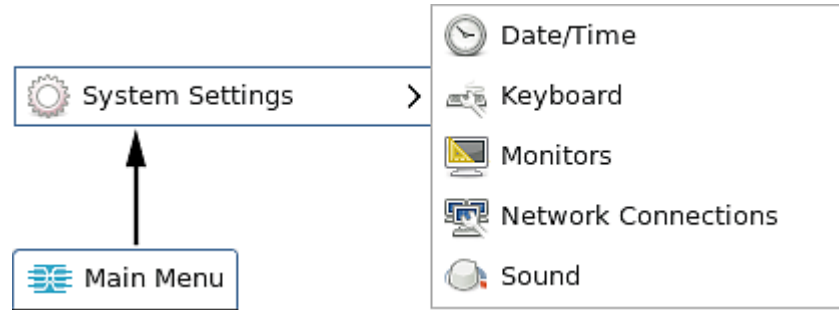

## In This Chapter

Date/Time .....	99
Keyboard .....	102
Monitors .....	109
Network Connections .....	111
Sound Preferences .....	120
Default Shortcut Icons in the Main Toolbar .....	122
Screen and Keyboard Settings in the Login Screen .....	130



## Date/Time

1. Choose Main Menu > System Settings > Date/Time. The date/time dialog appears.

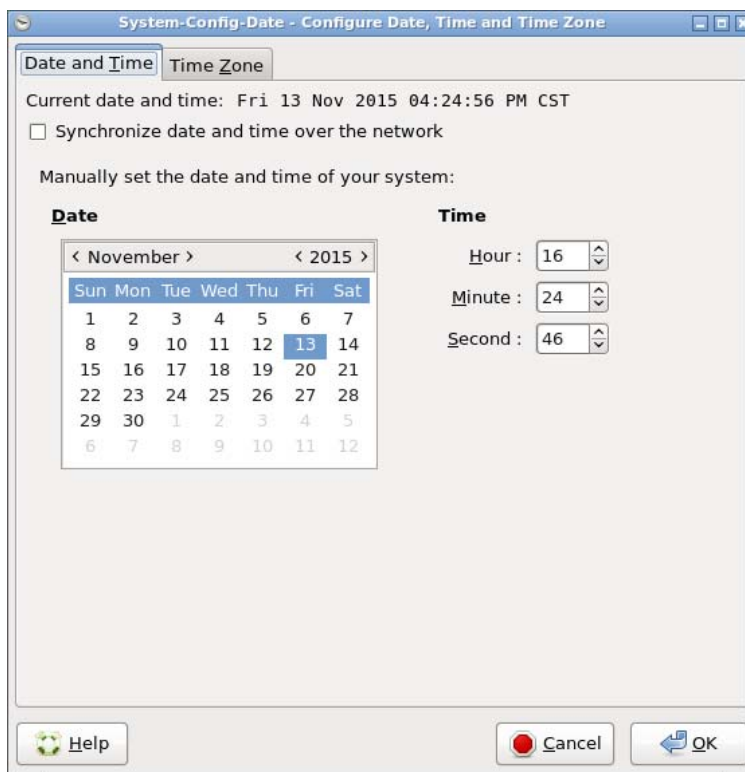

2. Click the desired tab to configure date/time settings for the User Station.
  - Configure the date and time using the tab labeled **Date and Time** (on page 100).
  - If the date and time synchronizes with an NTP server in the "Date and Time" tab, you must set the time zone correctly. See **Time Zone** (on page 101).

---

*Note: For "manually customized" date and time, the time zone setting does NOT affect the time displayed onscreen, but it does affect the internal UTC-based clock. Therefore, make sure the time zone setting is correct and do NOT change it unless required.*

---

3. You can click the Help button in this dialog for detailed information about the dialog.

---

## Date and Time

Follow one of the following procedures to set the date and time.

▶ **To manually customize the date and time:**

1. Select the Date and Time tab, if not yet.
2. Deselect the time synchronization checkbox.

**Synchronize date and time over the network**

3. Click a date in the calendar.
  - You can click the arrows next to the year or month to change the year or month.
4. Adjust the Hour, Minute and Second settings.

▶ **To synchronize with the NTP time server:**

1. Select the time synchronization checkbox.

**Synchronize date and time over the network**

2. NTP servers detected in your network are listed in the dialog.

### NTP Servers

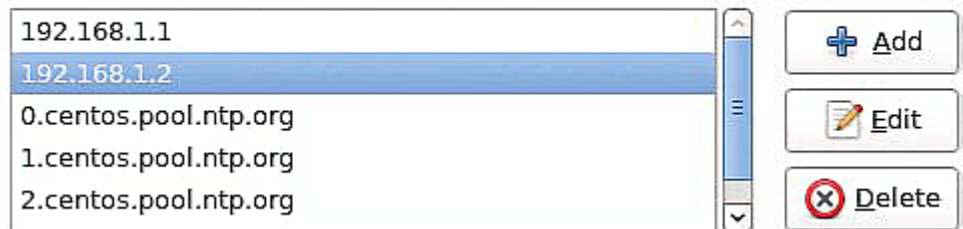

- If the desired NTP server is not listed, click Add and type its IP address/host name.
  - If any NTP server is incorrect, select it and click Edit to modify it.
  - If any NTP server is not needed, select it and click Delete.
3. Click Advanced Options to configure these checkboxes:
  - Speed up initial synchronization:
    - When selected, the initial time synchronization is faster while consuming more network bandwidth.
  - Use Local Time Source:

Select this only when you use a radio-controlled clock device to synchronize the User Station's clock with an authoritative time source.

## Time Zone

The time zone setting is important for both customized and NTP-synchronized time. If it is correct, do NOT change it unless required.

- For the time synchronized with an NTP server, time zone changes affect the time displayed onscreen, daylight savings time, and internal UTC-based clock on the User Station.
- For the "customized" date and time, time zone changes do NOT affect the time displayed onscreen, but they affect the internal UTC-based clock.

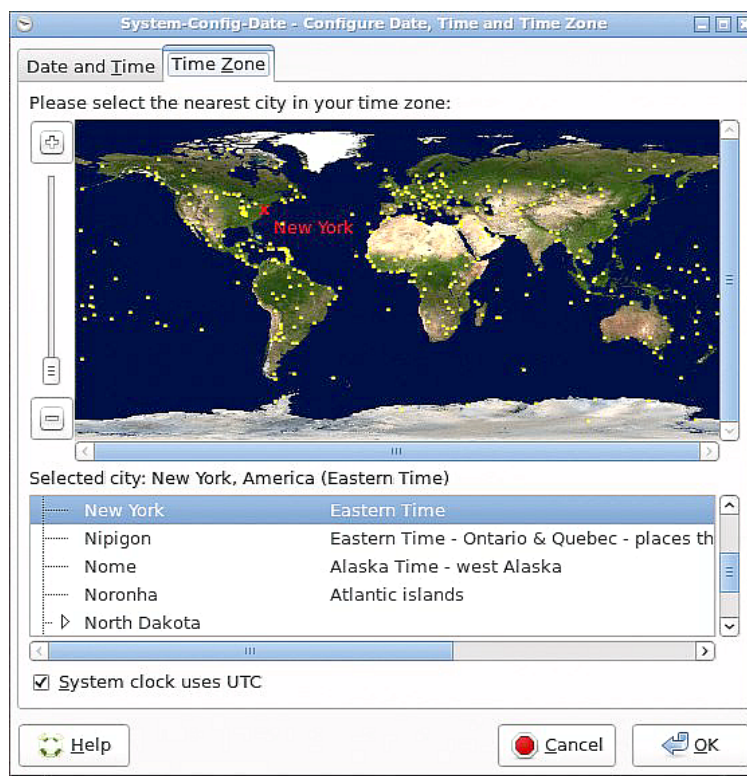

### ► To specify your time zone:

1. Click the Time Zone tab.
2. Click your city or a nearby city in the map.
  - You can scale the map by dragging the slider bar in the left side, or by clicking + (plus) and - (minus) buttons.
  - You can drag the map to move toward your destination.

3. Select your city's name in the list below the map.
4. To make the system time automatically switch between normal and day light savings time, select the "System clock uses UTC" checkbox.

---

## Keyboard

1. Choose Main Menu > System Settings > Keyboard. The Keyboard Preferences dialog appears.



2. Click any tab to configure different keyboard settings.
  - Configure the repeat keys and cursor blinking in the tab labeled **General** (on page 103).
  - Configure the keyboard layout in the tab labeled **Layouts** (on page 104).
  - Configure Sticky Keys, Slow Keys and Bounce Keys in the tab labeled **Accessibility** (on page 106).
  - To use the keypad to move the mouse pointer, configure **Mouse Keys** (on page 108).
  - To force the user to take a rest by locking the screen, configure **Typing Break** (on page 109).
3. You can click the Help button in this dialog for detailed information about the dialog.

4. In the "Type to test settings" field, type anything to verify the current keyboard settings.

---

### General

#### ▶ Repeat Keys:

1. Select this checkbox if you want the keys to repeat when you press and hold a key.

Key presses repeat when key is held down

2. Adjust the Delay slider bar to determine the length of time between pressing a key and the key repeat action. Left side is shorter and right side is longer.
3. Adjust the Speed slider bar to determine how fast the key repeats. Left side is slower and right side is faster.

#### ▶ Cursor Blinking:

1. Select this checkbox if you want the cursor to blink in a text box or field.

Cursor blinks in text fields

2. Adjust the Speed slider bar to determine the cursor blinking speed. Left side is faster and right side is slower.

## Layouts

In the Layouts tab, available keyboard layouts are all shown. The same keyboard layout list is also available when working with the keyboard icon in the Main Toolbar. Any changes made to the dialog's keyboard layout list also change the keyboard layout list available in the Main Toolbar. See **Main Screen and Main Toolbar** (on page 8).

A maximum of four layouts are supported.

### ► To manage available keyboard layouts:



- To resort the keyboard layout list, select one layout and click Move Up or Move Down.
- To delete a layout from the list, select it and click Remove.
- To view how a keyboard layout looks like, select it and click Show.
- To add a layout to the list, click Add. This button is disabled when there are *four* layouts in the list.

### ► To determine the layout applied to each window:

- Separate layout for each window:  
When this checkbox is selected, different keyboard layouts can be used in different windows so the change of the keyboard layout only affects the current window.
- New windows use active window's layout:  
This option is enabled when the above checkbox is selected. Select this checkbox only when you want the new windows to automatically follow the current window's keyboard layout.

- ▶ **To determine the keyboard model:**
  - Click the button in the Keyboard model field. Then select the vendor and model of your keyboard.
- ▶ **Reset to Defaults:**
  - Click this button to reset all keyboard settings to the defaults.
- ▶ **To determine keyboard behaviors:**
  - Usually it is not necessary to change your keyboard behaviors unless there are special needs. If so, click Options to select the options you want. See **Keyboard Options** (on page 105).

### Keyboard Options

Option	Description
Add currency signs to certain keys	Automatically add currency signs to one of these keys: 2, 4, 5, and E.
Add Esperando circumflexes (supersigno)	Automatically add Esperando circumflexes to certain keys.
Alt/Win key behavior	Determine the Alt and Windows key behavior.  For example, you can emulate the Meta, Super and Hyper keys on a Symbolics Space Cadet Keyboard using the Alt/Win keys on your modern keyboard.
Caps Lock key behavior	Determine the behavior of the Caps Lock key.  For example, you can make the Caps Lock key function as a Backspace key.
Compose key position	Determine which key functions as the Compose key on the Sun keyboard.
Ctrl key position	Determine which key functions as the Ctrl key.
Japanese keyboard options	Configure this option only when you are using a Japanese keyboard.
Key sequence to kill the X server	Enable using the hot key Ctrl+Alt+Backspace to restart the X server, which provides graphical desktop on the User Station.  You need to restart it only when it crashes.
Key(s) to change the layout	Select the key or key combination to change the keyboard layout.
Key to choose 3rd level	Specify the key to function as the 3rd level key (dead key).  A dead key generates extra symbols that are not available on your keyboard. For example, apply an accent to the next character you type.
Key to choose 5th level	Specify the key to function as the 5th level key. This is associated with a French keyboard layout.

Option	Description
Maintain key compatibility with old Solaris keycodes	Only Sun Key compatibility is available for this option.
Miscellaneous compatibility options	Miscellaneous keyboard behaviors are under this option. For example, you can make the Shift key function as a key that cancels the Caps Lock feature.
Numeric keypad delete key behavior	Determine the behavior of the Delete key on the keypad.
Numeric keypad layout selection	Determine the layout applying to your keypad.
Use keyboard LED to show alternative layout	Specify which keyboard LED should turn on when the change of the keyboard layout occurs.
Using space key to input non-breakable space character	Determine which type of non-breakable space character is generated by pressing the Space key.

---

### Accessibility

#### ► To show the accessibility icon in the Main Toolbar:

- Accessibility features can be toggled with keyboard shortcuts:  
Select this checkbox if you want an accessibility icon to appear in the Main Toolbar so that it is convenient to turn on or off accessibility features. See **Main Screen and Main Toolbar** (on page 8).

#### ► Sticky Keys:

- Simulate simultaneous keypresses:  
Activate this function when there are problems pressing more than one key simultaneously, such as the shortcut key for copy (Ctrl+C).
- Disable sticky keys if two keys are pressed together:  
The sticky keys function is automatically disabled when two keys are pressed simultaneously.

#### ► Slow Keys:

- Only accept long keypresses:  
Activate this function when a delay is intended between pressing and displaying a key. This means you must press a key for a while before it can be displayed on the screen.  
  
When activated, drag the slider bar to determine the delay. Left side is shorter and right side is longer.



► **Bounce Keys:**

- Ignore fast duplicate keypresses:

Activate this function to ignore those key presses that are rapidly repeated.

When activated, drag the slider bar to determine the delay. Left side is shorter and right side is longer.

► **Audio feedback:**

- General:

Option	Function
Beep when accessibility features are turned on or off	The User Station sounds when turning on or off any accessibility feature.
Beep when a toggle key is pressed	The User Station sounds when pressing a toggle key.

- Sticky Keys:

Option	Function
Beep when a modifier key is pressed	In the Sticky Keys mode, the User Station sounds when pressing a modifier key.

- Visual cues for sounds:

Option	Function
Show visual feedback for the alert sound	When an audible alert is issued, the User Station shows a visual alert: flashing window titlebar or flashing screen.
Flash window titlebar	The window's titlebar flashes when the audible alert is issued.
Flash entire screen	The entire screen flashes when the audible alert is issued.

- Slow Keys:

Option	Function
Beep when a key is pressed	In the Slow Keys mode, the User Station sounds when pressing any key.
Beep when key is accepted	In the Slow Keys mode, the User Station sounds when accepting any key pressed.
Beep when key is rejected	In the Slow Keys mode, the User Station sounds when rejecting any key pressed.

- Bounce Keys:

Option	Function
Beep when a key is rejected	In the Bounce Keys mode, the User Station sounds when rejecting any key pressed.

### Mouse Keys

When you want to use the numeric keypad to control the mouse pointer/cursor, select the checkbox labeled "Pointer can be controlled using the keyboard."

When enabled, each keypad key functions as the following table.

Key	Function
0	Depress the selected button
.	Release the selected button
1	Move toward the bottom-left corner
2	Move down
3	Move toward the bottom-right corner
4	Move left
5	Click the selected button
6	Move right
7	Move toward the top-left corner
8	Move up
9	Move toward the top-right corner
Num Lock	The other alternative to activate or deactivate the Mouse Keys function is to press <i>Left Alt+Left Shift+Num Lock</i> .
/	Select primary button
*	Select modifier button
-	Select alternate button
+	Double click the selected button
Enter	Enter

- Acceleration: Use the slider bar to adjust the pointer acceleration rate. Left side is faster and right side is slower.
- Speed: Use the slider bar to adjust the pointer speed. Left side is slower and right side is faster.
- Delay: Use the slider bar to adjust the delay prior to pointer movement. Left side is shorter and right side is faster.

### Typing Break

To force any user to take a break by locking the screen after a certain period of operation, select the checkbox labeled "Lock screen to enforce typing break."

Then configure the following fields.

Field	Function
Work interval lasts	Determine how long a user can work on the User Station before the screen is locked.
Break interval lasts	Determine how long the screen is locked.
Allow postponing of breaks	Determine whether a Postpone Break button is shown at the bottom-right corner of the screen so that the user can postpone the typing break.

## Monitors

1. Choose Main Menu > System Settings > Monitors. The Monitor Preferences dialog appears.

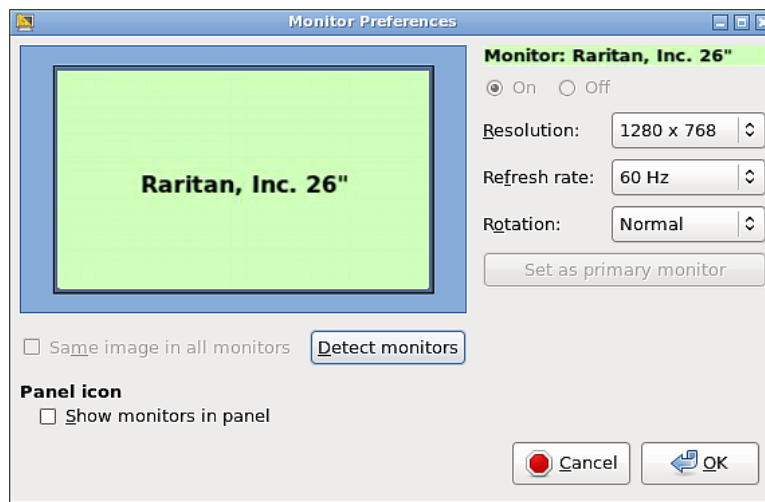

2. Perform or configure any of the following function:

Setting/button	Function
On/Off	Turn on or off this monitor, if there are two monitors connected to the User Station.  This setting is disabled when only one monitor is connected.
Resolution	Determine the video resolution applied to this monitor.
Refresh rate	Determine the refresh rate applied to this monitor.
Rotation	Determine how the image on the screen should be rotated, if intended.
Set as primary monitor	Click this button to specify this monitor as the primary monitor, when there are two monitors connected.  This button is disabled when: <ul style="list-style-type: none"> <li>▪ Only one monitor is connected.</li> <li>▪ OR this monitor has been set as the primary one.</li> </ul>
Same image in all monitors	If two monitors are connected, determine whether both monitors show the same image.  This setting is disabled when only one monitor is connected.
Detect monitors	Click this button if any connected monitor is not detected. Usually it is not necessary to use this function when there is only one monitor connected.
Show monitors in panel	Determine whether the monitor icon is added to the Main Toolbar. See <b>Main Screen and Main Toolbar</b> (on page 8).

3. If any settings are changed, click OK to save new settings or Cancel to cancel.
  - If clicking OK, a confirmation message appears. Click Restore Previous Configuration to restore to the original settings, or click Keep This Configuration to apply the new settings.

## Network Connections

You can connect the two LAN ports of the User Station to the same or diverse subnets.

If you have connected both LAN ports to the network(s) when turning on or restarting the User Station, the User Station *randomly* selects one of the network connections as the default one. However, if you change the network settings of either or both connections, the "final" one that is changed will automatically become the default connection.

---

*Note: You can identify the default connection in the Connection Information dialog. See **Network Icon** (on page 123).*

---

By default, both IPv4 and IPv6 addressing are enabled for both LAN ports, and the following are the default network settings:

- IPv4: *Automatic (DHCP)*
- IPv6: *Automatic*

► **To change network settings:**

1. Choose Main Menu > System Settings > Network Connections. The Network Connections dialog appears, with two factory default connections listed for two LAN ports.
  - *enp2s0* is for the LAN port near the power jack, and *enp3s0* is for the other.

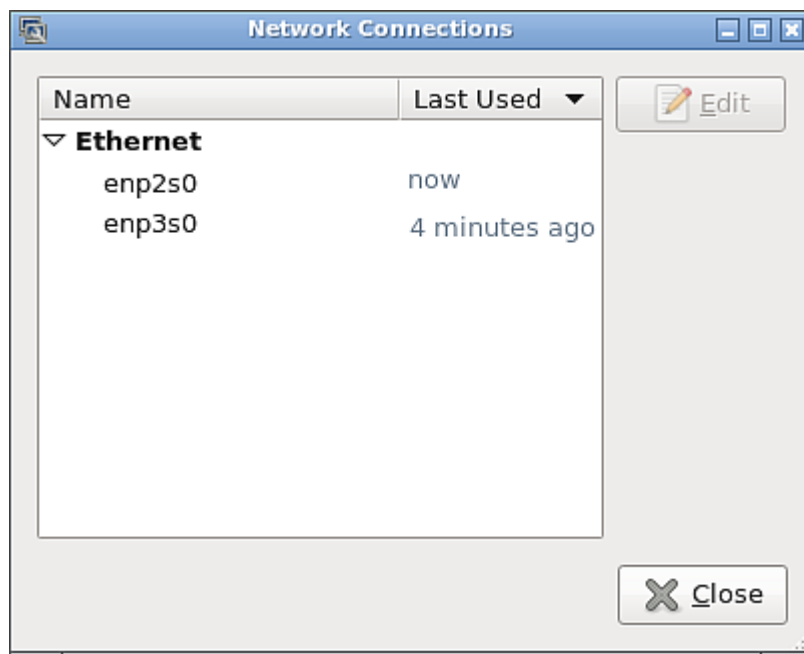

2. Select the desired connection, and click Edit. A dialog similar to the following appears.

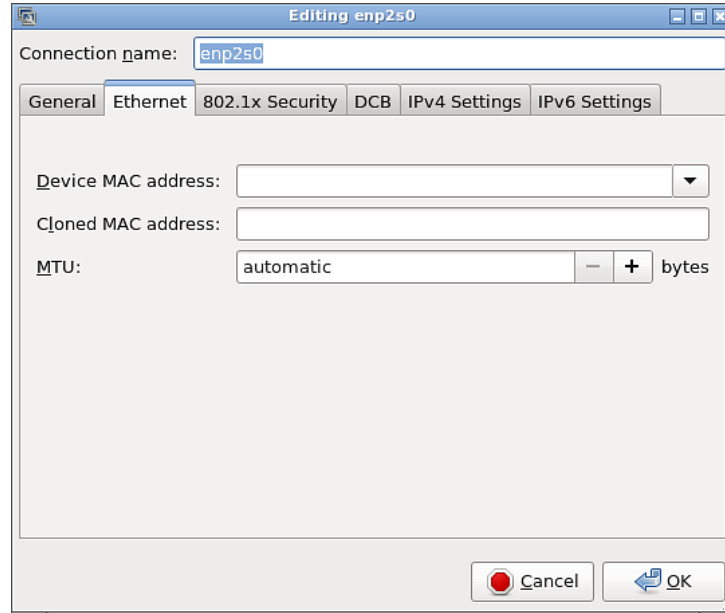

3. If intended, type a new name for identifying this connection in the "Connection name" field.
4. Click the IPv4 Settings and/or IPv6 Settings tab to configure network settings properly.

---

*Note: You can ignore those settings in the other tabs of this dialog because it is strongly recommended NOT to configure or change them.*

---

▪ **IPv4 Settings:**

Setting	Description
Method	<p>Select one of the following as the connection method and configure associated settings:</p> <ul style="list-style-type: none"> <li>▪ Automatic (DHCP)</li> <li>▪ Automatic (DHCP) addresses only</li> <li>▪ Manual</li> <li>▪ Link-Local Only</li> <li>▪ Disabled</li> </ul> <p>The option "Shared to other computers" is NOT supported.</p> <p>See <b>IPv4 Settings</b> (on page 113).</p>

▪ **IPv6 Settings:**

Setting	Description
Method	Select one of the following as the connection method: <ul style="list-style-type: none"> <li>▪ Automatic</li> <li>▪ Automatic, addresses only</li> <li>▪ Automatic, DHCP only</li> <li>▪ Manual</li> <li>▪ Link-Local Only</li> <li>▪ Ignore</li> </ul> See <b>IPv6 Settings</b> (on page 117).

5. Click OK. The new network settings apply now.
6. To change the network settings for the other connection, select the other one and repeat steps 2 to 5.

---

*Note: You can retrieve current IP addresses from the Connection Information dialog. See **Network Icon** (on page 123).*

---

**IPv4 Settings**

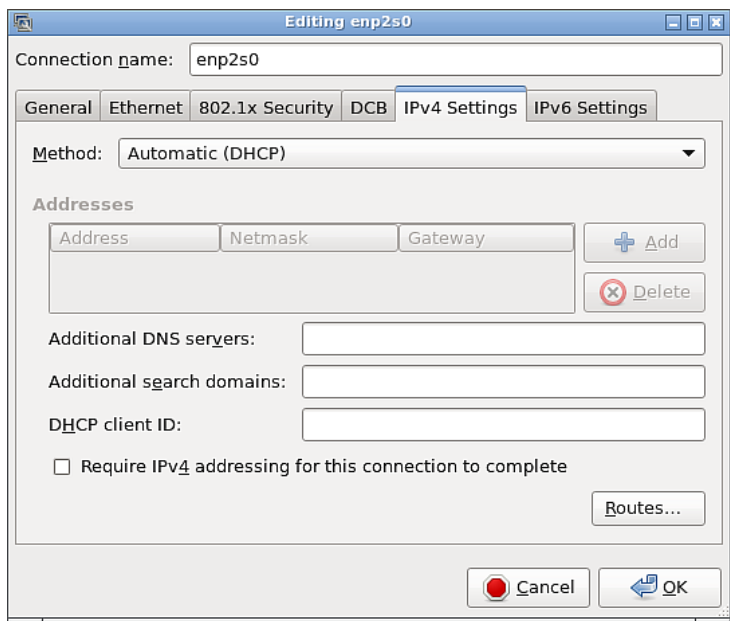

---

*Note: The option "Shared to other computers" is NOT supported.*

---

► **Automatic (DHCP):**

The DHCP server in the network automatically assigns an IPv4 address to the User Station as well as DNS server(s) and domain(s).

The following settings are configurable for this method.

Setting	Description
Additional DNS servers	<p><b>Optional.</b></p> <p>You may specify IP addresses of one or multiple additional DNS servers for resolving host names.</p> <p>Use commas to separate multiple servers.</p>
Additional search domains	<p><b>Optional.</b></p> <p>You may specify IP addresses of one or multiple additional domains for resolving host names.</p> <p>Use commas to separate multiple servers.</p>
DHCP client ID	<p><b>Optional.</b></p> <p>You can specify a DHCP client ID for identifying this User Station in the network.</p>
Require IPv4 addressing for this connection to complete	<p>When deselected, either IPv4 or IPv6 addressing can be used to establish the connection.</p> <p>When selected, only IPv4 addressing is used for making the connection.</p>



Setting	Description
Routes	<p><b>Optional.</b></p> <p>Configure the IPv4 routing for this User Station.</p> <ul style="list-style-type: none"> <li>▪ Click Add to add one or multiple routing addresses for the User Station to reach in the network.</li> <li>▪ To remove any existing routes, select it and click Delete.</li> <li>▪ <i>Ignore automatically obtained routes:</i> Select this checkbox only when you want to use manually-specified routes.</li> <li>▪ <i>Use this connection only for resources on its network:</i> If selected, this connection will be used only when retrieving resources from the network. It will never be used as the default network connection.</li> </ul>

---

*Note: You can retrieve current IP addresses from the Connection Information dialog. See **Network Icon** (on page 123).*

---

► **Automatic (DHCP) addresses only:**

The DHCP server in the network automatically assigns an IPv4 address to the User Station, but no DNS servers or domain servers are specified.

The following settings are configurable for this method.

Setting	Description
DNS servers	<p>Specify IP addresses of one or multiple DNS servers.</p> <p>Use commas to separate multiple servers.</p>
Search domains	<p>Specify IP addresses of one or multiple domains for resolving host names.</p> <p>Use commas to separate multiple servers.</p>
DHCP client ID	<p>See the above table for information of these fields/options.</p>
Require IPv4 addressing for this connection to complete	
Routes	

► **Manual:**

Select this method when intending to manually assign a static IP address to the User Station.

In the Addresses section, click Add and then type the User Station's IPv4 address, netmask and gateway in this section. At least one IPv4 address, netmask and gateway must be specified.

**Addresses**

Address	Netmask	Gateway	 Add
192.168.60.80	255.255.255.0	192.168.60.1	

The following settings are configurable for this method. See the above table for associated information.

- DNS servers
- Search domains
- Require IPv4 addressing for this connection to complete
- Routes

► **Link-Local Only:**

With this method selected, a link-local IPv4 address is automatically assigned to the User Station when there is no DHCP available in the network.

Only the following option is available for this method:

- Require IPv4 addressing for this connection to complete

► **Disabled:**

The IPv4 networking settings are all disabled.

## IPv6 Settings

Editing enp2s0

Connection name: enp2s0

General Ethernet 802.1x Security DCB IPv4 Settings **IPv6 Settings**

Method: Automatic

Addresses

Address	Prefix	Gateway

+ Add

⊗ Delete

Additional DNS servers:

Additional search domains:

IPv6 privacy extensions: Disabled

Require IPv6 addressing for this connection to complete

Routes...

Cancel OK

### ► Automatic:

IPv6 autoconfiguration automatically assigns an IPv6 address to the User Station, and retrieves the information of DNS server(s) and domain(s) from the DHCP server.

The following settings are configurable for this method.

Setting	Description
Additional DNS servers	<p><b>Optional.</b></p> <p>You may specify IP addresses of one or multiple additional DNS servers for resolving host names.</p> <p>Use commas to separate multiple servers.</p>
Additional search domains	<p><b>Optional.</b></p> <p>You may specify IP addresses of one or multiple additional domains for resolving host names.</p> <p>Use commas to separate multiple servers.</p>

Setting	Description
IPv6 privacy extensions	<p>Determine whether and how privacy extensions apply to the IPv6 addressing.</p> <ul style="list-style-type: none"> <li>▪ Disabled: Disables privacy extensions.</li> <li>▪ Enabled (prefer public address): Enables privacy extensions and a public address is preferred.</li> <li>▪ Enabled (prefer temporary address): Enables privacy extensions and a temporary address is preferred.</li> </ul>
Require IPv6 addressing for this connection to complete	<p>When deselected, either IPv4 or IPv6 addressing can be used to establish the connection.</p> <p>When selected, only IPv6 addressing is used for making the connection.</p>
Routes	<p><b>Optional.</b></p> <p>Configure the IPv6 routing for this User Station.</p> <ul style="list-style-type: none"> <li>▪ Click Add to add one or multiple routing addresses for the User Station to reach in the network.</li> <li>▪ To remove any existing routes, select it and click Delete.</li> <li>▪ <i>Ignore automatically obtained routes:</i> Select this checkbox only when you want to use manually-specified routes.</li> <li>▪ <i>Use this connection only for resources on its network:</i> If selected, this connection will be used only when retrieving resources from the network. It will never be used as the default network connection.</li> </ul>

---

*Note: You can retrieve current IP addresses from the Connection Information dialog. See **Network Icon** (on page 123).*

---

► **Automatic, addresses only:**

IPv6 autoconfiguration automatically assigns an IPv6 address to the User Station, but no DNS servers or domain servers are specified.

The following settings are configurable for this method.

Setting	Description
DNS servers	Specify IP addresses of one or multiple DNS servers. Use commas to separate multiple servers.
Search domains	Specify IP addresses of one or multiple domains for resolving host names. Use commas to separate multiple servers.
IPv6 privacy extensions	See the above table for information of these fields/options.
Require IPv6 addressing for this connection to complete	
Routes	

► **Automatic, DHCP only:**

The DHCPv6 server in the network automatically assigns an IPv6 address to the User Station, and specify DNS server(s) and domain(s).

The following settings are configurable for this method. See the above table for associated information.



- Require IPv6 addressing for this connection to complete
- Routes

► **Manual:**

Select this method when intending to manually assign a static IP address to the User Station.

In the Addresses section, click Add and then type the User Station's IPv6 address, prefix and gateway in this section. At least one IPv6 address, prefix and gateway must be specified.

**Addresses**

Address	Prefix	Gateway	
2605:0:2:1::5	64	2605:0:2:3::1	
			

The following settings are configurable for this method. See the above table for associated information.

- DNS servers
- Search domains

- Require IPv6 addressing for this connection to complete
- Routes

▶ **Link-Local Only:**

With this method selected, a link-local IPv6 address is automatically assigned to the User Station when there is no DHCPv6 available in the network.

Only the following option is available for this method:

- Require IPv6 addressing for this connection to complete

▶ **Ignore:**

The IPv6 networking settings are all disabled.

---

## Sound Preferences

1. Choose Main Menu > System Settings > Sound Preferences. The Sound Preferences dialog appears.

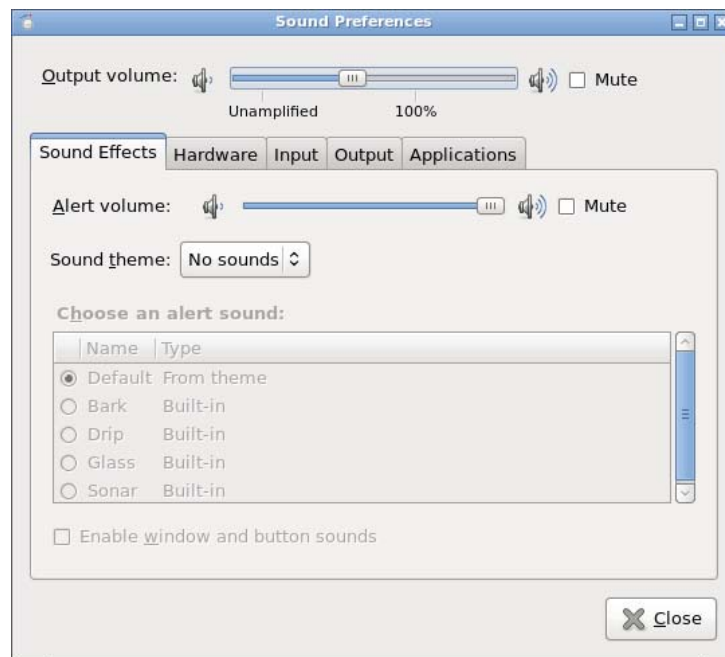

2. In the "Output volume" field, drag the slider bar to change the sound volume.
  - To mute the volume, select Mute.
3. Then click any of the following tabs to configure additional sound settings.
  - **Hardware** (on page 121)

- **Input** (on page 122)
- **Output** (on page 122)

---

*Note: The Sound Effects and Applications tabs are NOT supported.*

---

## Hardware

The User Station has two types of built-in audio channels:

- Audio channels for Microphone and Audio Output ports. See **Front View** (on page 4).
- Audio channels for the HDMI port. See **Rear View** (on page 5).

### ► To configure any built-in audio device:

1. Click the audio device you want to configure.
2. In the Profile field, select a profile to apply to the selected audio device.

Profile	Description
Off	This disables the selected audio channels.
Analog Stereo Input	Apply analog stereo input to the select audio channels. Audio output is disabled.
Digital Stereo (IEC958) Output	Apply digital stereo output to the selected audio channels. Audio input is disabled.
Digital Stereo (IEC958) Output + Analog Stereo Input	Apply digital stereo output and analog stereo input to the selected audio channels.
Analog Stereo Output	Apply analog stereo output to the selected audio channels. Audio input is disabled.
Analog Stereo Duplex	Apply analog stereo duplex to the selected audio channels.
Digital Surround 5.1 (HDMI) Output	Apply digital surround 5.1 output to the selected audio channels. No audio input is available.
Digital Stereo (HDMI) Output	Apply digital stereo output to the selected audio channels. No audio input is available.

3. If the profile you selected is related to the audio output, a Test Speakers button is shown for your to test each audio channel's output.
  - Make sure a speaker or headphones have been connected when testing the audio output.

---

### Input

The audio input setting is NOT configurable if the audio profile you selected in the Hardware tab enables the audio output only.

- Determine the audio input volume by adjusting the "Input volume" slider bar.
- To disable the audio input channel, select Mute.

---

*Note: Ignore the other fields in this tab since they are not configurable.*

---

### Output

The User Station has two types of built-in audio output ports.

- Audio Output port. See **Front View** (on page 4).
  - HDMI port. See **Rear View** (on page 5).
- **To configure the audio output:**
1. Click the audio output device you want to configure.
  2. Adjust available output settings:
    - Balance: Determine the balance between left and right speakers.
    - Fade: Determine the balance between front and rear speakers.
    - Subwoofer: Determine the strength of the low-frequency subwoofer channel.

---

*Note: Fade and Subwoofer settings are available for digital audio surround 5.1 profile only.*

---

---

## Default Shortcut Icons in the Main Toolbar

Shortcut icons in the Main Toolbar provides quick access to some system settings. For information on the Main Toolbar, see **Main Screen and Main Toolbar** (on page 8).

This section introduces the following factory default icons.

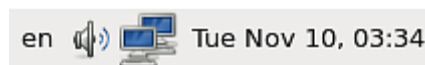



---

## Keyboard Layout Icon

en

### ▶ Clicking the icon:

The keyboard layout switches among available languages. By default, the following languages are available.

- *en* - English (US)
- *es* - Spanish
- *fr* - French
- *de* - German

### ▶ Right-clicking the icon:

A shortcut menu with these commands displays.

- *Layouts*: Changes the keyboard layout.
- *Keyboard Preferences*: Triggers the Keyboard Preferences dialog. See **Keyboard** (on page 102).
- *Show Current Layout*: Shows a keyboard image to indicate the current layout.

---

## Volume Icon



### ▶ Clicking the icon:

A slider bar displays for you to adjust the volume.

### ▶ Right-clicking the icon:

A shortcut menu with these commands displays.

- *Mute*: Mutes the sound.
- *Sound Preferences*: Triggers the Sound Preferences dialog. See **Sound Preferences** (on page 120).

---

## Network Icon



► **Clicking the icon:**

A list of available Ethernet networks and connections displays.

- Only one network connection is shown if only one LAN port is connected to the network.
- Two network connections are listed if both LAN ports are connected to the network.
- By default, *enp2s0* is for the LAN port near the power jack, and *enp3s0* is for the other.

An "active" network connection is highlighted in bold, with a Disconnect command following it. To disable any active connection, select Disconnect.

- The formatting of that connection's name turns from bold to normal, indicating that it becomes inactive.

To activate any disabled network connection shown in the list, click it.

- The formatting of that connection's name turns from normal to bold, indicating that it becomes active.

► **Right-clicking the icon:**

A shortcut menu with these commands displays.

- *Enable Networking*: Enables or disables the networking capability. The default is to enable it.
- *Connection Information*: This command shows the networking information of the User Station, including IPv4 and IPv6 addresses.

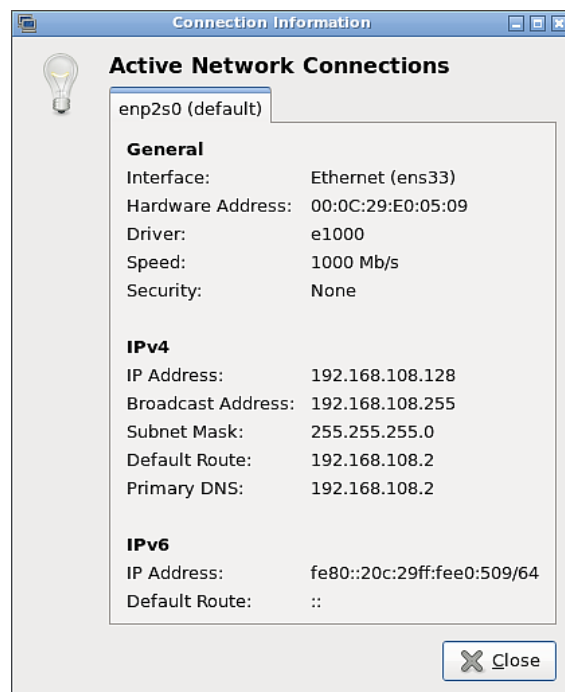

- When only one network connection is active, this dialog shows one tab.
- When both network connections are active, this dialog shows two tabs.
- The default connection has the word "default" shown on its tab.
- *Edit Connections*: This triggers the Network Connections dialog. See **Network Connections** (on page 111).

---

### Clock Icon

Tue Nov 10, 03:34

► **Clicking the icon:**

A calendar displays, as well as the Locations section.

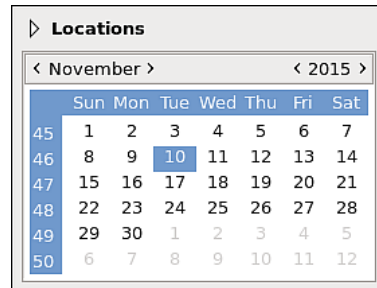

You can click "Locations" to:

- Determine the location of the User Station.
- Change the time format of the clock shown in the Main Toolbar.

For details, see **Location and Clock Time Format** (on page 127).

To close the calendar, click the clock icon in the Main Toolbar again.

► **Right-clicking the icon:**

A shortcut menu with these commands displays.

- *Copy Time*: Copies the current time.
- *Copy Date*: Copies the current date.
- *Help*: Shows the online help of the Clock applet.
- *About*: Shows the Clock applet's version information.

### Location and Clock Time Format

After expanding the Locations section, click Edit.

▼ **Locations** Edit



< November > < 2015 >

	Sun	Mon	Tue	Wed	Thu	Fri	Sat
45	1	2	3	4	5	6	7
46	8	9	10	11	12	13	14
47	15	16	17	18	19	20	21
48	22	23	24	25	26	27	28
49	29	30	1	2	3	4	5
50	6	7	8	9	10	11	12

The Clock Preferences dialog appears. Click the desired tab or button to configure settings.

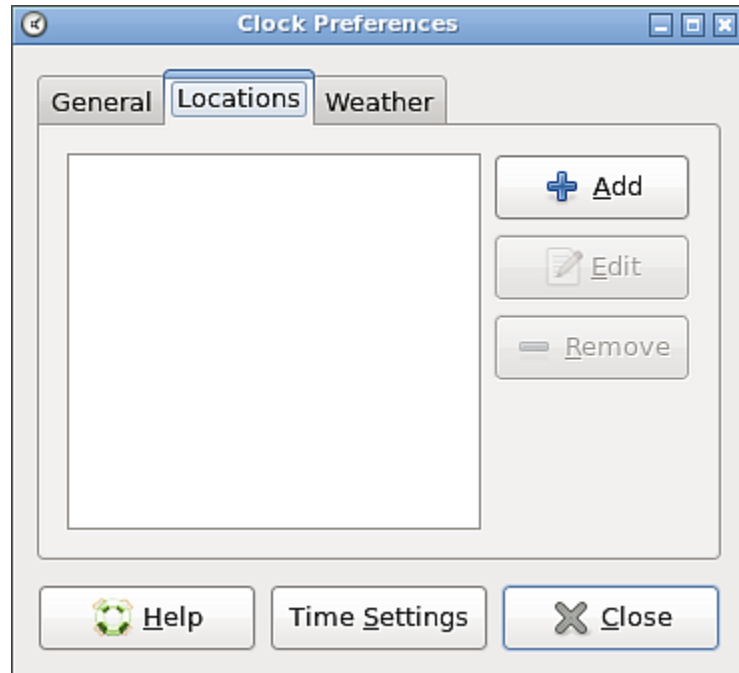

▶ **Help:**

- You can click the Help button in this dialog for detailed information about the dialog.

▶ **Time Settings:**

- See **Date/Time** (on page 99).

▶ **Locations:**

- Click Add to specify your city or country.
  - You can simply type the city or country name in the Location Name field and then select the correct one from the list that appears.
  - If your city's or country's name is not available in the list, you can manually specify the Timezone, Latitude and Longitude.

- To modify or delete any existing location in the Locations tab, select it and click Edit or Remove.

► **General:**

- *Clock Format:* Select the desired clock format to be shown in the Main Toolbar - 12 or 24 hour format.
- *Panel Display:* Select the information that is shown or available via the Main Toolbar - date, seconds, weather and temperature.
  - If date and seconds are selected, their information is shown in the clock on the Main Toolbar.
  - If weather and temperature are selected, their information is shown in the Locations section when you hover your mouse pointer over the small icon below the location name. See the following diagram.

The weather information includes the weather, temperature, wind speed and the time for sunrise/sunset.

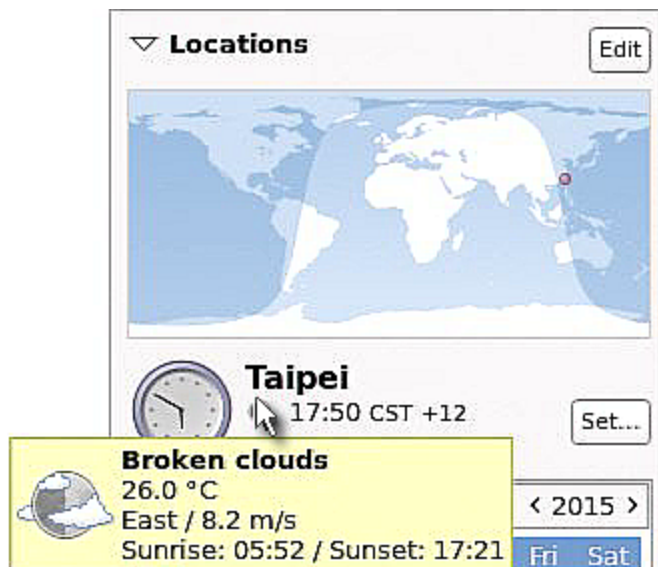

---

*Note: Ignore the Set button that may appear to the right because you are not allowed to configure this setting.*

---

► **Weather:**

- Determine the temperature unit: C (degree Celsius), F (degree Fahrenheit) or K (degree Kelvin).
- Determine the wind speed unit: m/s, km/h, mph, knots, or Beaufort scale.

## Screen and Keyboard Settings in the Login Screen

The following settings are available in the Login Screen, and their changes only impact the **Login Screen** (on page 6).

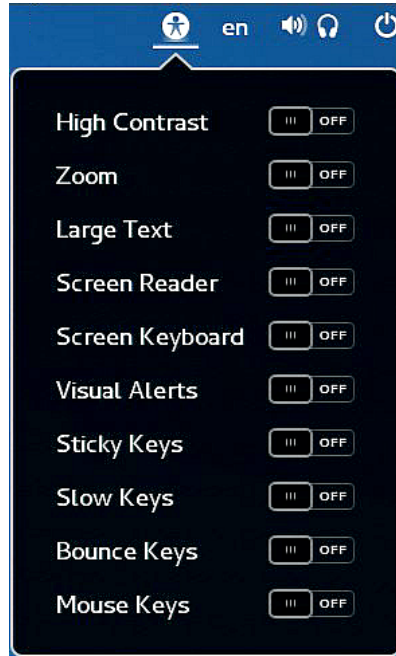

To turn any item on or off, just click it.

*Note: Screen Reader is NOT supported.*

Setting	Description
High Contrast	Sharpen the contrast of the screen.
Zoom	Zoom in the screen.
Large Text	Enlarge the text onscreen.
Screen Keyboard	Show an onscreen keyboard for users to enter data.  This is useful when there is no keyboard connected or the keyboard is broken.
Visual Alerts	See <b>Accessibility</b> (on page 106).
Sticky Keys	See <b>Accessibility</b> (on page 106).
Slow Keys	See <b>Accessibility</b> (on page 106).
Bounce Keys	See <b>Accessibility</b> (on page 106).



Setting	Description
Mouse Keys	See <b><i>Mouse Keys</i></b> (on page 108).

## Appendix A Specification

<b>Chassis design</b>	Slim 1.3 litre metal chassis, black
<b>Dimension (LxWxH)</b>	190 x 165 x 43 mm
<b>Operating temperature</b>	0 to 40 degrees Celsius
<b>Humidity</b>	non-condensing: 10~90%
<b>VESA mount</b>	<ul style="list-style-type: none"><li>▪ 75 x 75 mm</li><li>▪ 100 x 100 mm</li></ul>
<b>Video</b>	<ul style="list-style-type: none"><li>▪ 1 x HDMI</li><li>▪ 2 x DisplayPort</li><li>▪ Support video resolutions up to 3840 x 2560</li></ul>
<b>I/O ports</b>	<ul style="list-style-type: none"><li>▪ 1 x SD card reader</li><li>▪ 2 x Audio (Line out, mic)</li><li>▪ 2 x USB 3.0 (rear), 6 x USB 2.0 (4 front, 2 rear)</li><li>▪ 2 x Gigabit LAN (RJ-45), supports WOL, PXE</li><li>▪ 2 x COM ports (RS-232 + RS-232/RS-422/RS-485)</li></ul>
<b>Power supply</b>	External 90W fanless power adapter

## Appendix B Authentication of User Stations and KVM Switches

User credentials you use to log in to the Dominion User Station can be different or identical to the user credentials you enter for accessing the port information of any KX III KVM switch.

### ► User Station's user credentials:

User credentials for logging in to the User Station determine the tasks/permissions you are allowed to perform on the User Station, but not the tasks/permissions you can perform on KVM switches and KVM ports.

For example, user credentials of the User Station determine whether you can add or remove the data of KVM switches, or whether you can back up and restore the User Station settings.

For detailed information on what you can do on a User Station, see **Privileges** (on page 87).

### ► KVM Switch's user credentials:

User credentials entered for KVM switches determine the tasks/permissions you are allowed to perform while accessing computer devices connected to KVM ports (that is, target servers).

For example, user credentials for the KVM switch determine whether you can access all KVM ports on this KVM switch, or whether you can perform the virtual media or power control function on a KVM port/target server.

This is why users of the User Station CANNOT share user credentials of KVM switches, and each user must enter and save his or her own user credentials for KVM switches respectively. See **Editing KVM Switches** (on page 30).

For detailed information on what you can do with a KVM port/target server, see the user documentation for KX III KVM switches, which is accessible from the KVM switch's application or KX III section of Raritan website's **Support page** (<http://www.raritan.com/support/>).

### ► Examples:

The following table illustrates different combinations of user credentials for User Stations and KVM switches.

User account for the User Station	Tasks you can do on the User Station	User account for the KVM switch	Tasks you can do on a KVM port/target server
admin	<p>You can do anything, including:</p> <ul style="list-style-type: none"> <li>▪ System administration, such as backup or software update.</li> <li>▪ Device administration, such as adding KVM switches.</li> <li>▪ Device access, such as access to the data of all KVM switches and KVM ports.</li> </ul>	user-A	<p>Limited privileges are granted:</p> <ul style="list-style-type: none"> <li>▪ Port access permitted.</li> <li>▪ No virtual media access permitted.</li> <li>▪ No power control permitted.</li> </ul>
user-1	<p>Limited privileges are granted:</p> <ul style="list-style-type: none"> <li>▪ Device access permitted.</li> <li>▪ No device administration permitted.</li> <li>▪ No system administration permitted</li> </ul>	admin	<p>You can do anything, including:</p> <ul style="list-style-type: none"> <li>▪ Port access.</li> <li>▪ Virtual media access.</li> <li>▪ Power control permitted.</li> </ul>
user-1	Limited privileges are granted. See the above.	user-A	Limited privileges are granted. See the above.

## Appendix C Available Key Sets

The following table shows available key sets for **Keyboard Macros** (on page 74). Note that a few keys may belong to more than one key set.

Key set	Keys contained
Letters	A to Z
Numbers	0 to 9
Non-Graphic Keys	<ul style="list-style-type: none"> <li>▪ Left Windows Key</li> <li>▪ Right Windows Key</li> <li>▪ Menu Key</li> <li>▪ Print Screen/SysRq</li> <li>▪ Pause</li> <li>▪ ESC</li> <li>▪ Enter</li> <li>▪ Delete</li> <li>▪ Insert</li> <li>▪ Space Bar</li> <li>▪ Tab</li> <li>▪ Key Pad Enter</li> <li>▪ Backspace</li> <li>▪ Home</li> <li>▪ End</li> <li>▪ Page Up</li> <li>▪ Page Down</li> </ul>
Shift Modifiers	<ul style="list-style-type: none"> <li>▪ Left Ctrl</li> <li>▪ Right Ctrl</li> <li>▪ Left Alt</li> <li>▪ Right Alt</li> <li>▪ Left Shift</li> <li>▪ Right Shift</li> <li>▪ Scroll Lock</li> <li>▪ Caps Lock</li> <li>▪ Num Lock</li> </ul>

Key set	Keys contained
Symbols	<ul style="list-style-type: none"> <li>▪ - (Minus)</li> <li>▪ = (Equals)</li> <li>▪ [ (Left Bracket)</li> <li>▪ ] (Right Bracket)</li> <li>▪ \ (Back Slash)</li> <li>▪ ; (Semi-colon)</li> <li>▪ ' (Apostrophe)</li> <li>▪ ` (Grave)</li> <li>▪ , (Comma)</li> <li>▪ . (Period)</li> </ul>
Direction Keys	<ul style="list-style-type: none"> <li>▪ Tab</li> <li>▪ Backspace</li> <li>▪ Home</li> <li>▪ End</li> <li>▪ Page Up</li> <li>▪ Page Down</li> <li>▪ Right Arrow</li> <li>▪ Left Arrow</li> <li>▪ Up Arrow</li> <li>▪ Down Arrow</li> </ul>
F1-F16	F1 to F16
Key Pad Keys	<p>All keys on the key pad, including:</p> <ul style="list-style-type: none"> <li>▪ . (period)</li> <li>▪ 0 to 9</li> <li>▪ Enter</li> <li>▪ +</li> <li>▪ -</li> <li>▪ *</li> <li>▪ /</li> </ul>
Special Functions	<p>Delay time in milliseconds (ms), including:</p> <ul style="list-style-type: none"> <li>▪ 25 ms</li> <li>▪ 100 ms</li> <li>▪ 500 ms</li> <li>▪ 1000 ms</li> </ul>

Key set	Keys contained
Japanese Keys	<ul style="list-style-type: none"> <li>▪ Japan Kana</li> <li>▪ Japan Convert</li> <li>▪ Japan No Convert</li> <li>▪ Japan Yen</li> <li>▪ Japan Circumflex</li> <li>▪ Japan @</li> <li>▪ Japan :</li> <li>▪ Japan Kanji</li> <li>▪ Japan Ro</li> </ul>
Korean Keys	<ul style="list-style-type: none"> <li>▪ Korea Hanja</li> <li>▪ Korea Hanjul</li> </ul>
Sun Keys	<p>Specials keys on the Sun keyboard, including:</p> <ul style="list-style-type: none"> <li>▪ Stop</li> <li>▪ Again</li> <li>▪ Undo</li> <li>▪ Cut</li> <li>▪ Copy</li> <li>▪ Paste</li> <li>▪ Find</li> <li>▪ Mute</li> <li>▪ Volume Up</li> <li>▪ Volume Down</li> <li>▪ Props</li> <li>▪ Front</li> <li>▪ Help</li> <li>▪ Compose</li> <li>▪ Open</li> </ul>

## Appendix D Hot Keys for Controlling User Station Windows

You can use pre-programmed hot keys to move or resize any active window on the User Station, such as the Port Navigator window or a KVM Client window.

Hot key	Function
Ctrl + Alt + Shift + ←	When there are two monitors connected, move the window to the other monitor.
Ctrl + Alt + Shift + →	
Ctrl + Alt + ↑	Move the window to the screen edge in the specified direction on the monitor.
Ctrl + Alt + ↓	
Ctrl + Alt + ←	
Ctrl + Alt + →	
Ctrl + Alt + 1 (on the keypad)	Move the window to the screen corner in the specified direction on the monitor.
Ctrl + Alt + 3 (on the keypad)	
Ctrl + Alt + 7 (on the keypad)	
Ctrl + Alt + 9 (on the keypad)	
Ctrl + Shift + ↑	Move the window, in the specified direction, to the nearest edge, which is one of the following: <ul style="list-style-type: none"> <li>▪ Borders of another window</li> <li>▪ Monitor edges in the dual-monitor configuration</li> <li>▪ Desktop boundaries</li> </ul>
Ctrl + Shift + ↓	
Ctrl + Shift + ←	
Ctrl + Shift + →	
Ctrl + Windows + ↑	Enlarge the window in the specified direction until its border touches the nearest edge, which is one of the following: <ul style="list-style-type: none"> <li>▪ Borders of another window</li> <li>▪ Monitor edges in the dual-monitor configuration</li> <li>▪ Desktop boundaries</li> </ul>
Ctrl + Windows + ↓	
Ctrl + Windows + ←	<hr/> <i>Note: If the window border already aligns with the screen edge, the window size shrinks instead.</i> <hr/>
Ctrl + Windows + →	
Alt + Windows + ↑	Shrink the window in the specified direction until its border touches the nearest edge, which is one of the following: <ul style="list-style-type: none"> <li>▪ Borders of another window</li> <li>▪ Monitor edges in the dual-monitor configuration</li> <li>▪ Desktop boundaries</li> </ul>
Alt + Windows + ↓	



Hot key	Function
Alt + Windows + ←	<i>Note: If no nearest edges are found in the specified direction, the window size is halved instead.</i>
Alt + Windows + →	
Alt + Left mouse button	While pressing Alt, press and "hold down" the left mouse button to drag the window to the new location onscreen.

---

*Tip: For a complete list of pre-programmed hot keys of the User Station, you can refer to "Help on Hotkeys" in the Main Menu. See **Online Help and Hot Keys Help** (on page 10).*

---

# Index

## A

About this Device • 94, 96  
Absolute Mouse Mode • 52, 53, 55  
Accessibility • 102, 106, 130  
Adding KVM Switches • 28, 29  
Administration Features • 28, 81  
Advanced Color Settings • 57, 60  
Advanced Video Settings • 57, 58  
Audio • 33, 61, 64, 69  
Audio Settings • 69, 78  
Authentication of User Stations and KVM Switches • 14, 30, 65, 82, 133  
Automatic Mouse Mode • 54  
Available Key Sets • 75, 135

## B

Backup and Restore • 89, 94  
Basic Network Settings • 13, 21

## C

Clock Icon • 9, 125  
Color Accuracy • 46, 49  
Configuring KVM Ports • 10, 15, 31, 39, 69  
Connecting Audio Devices • 69  
Connection Properties • 46

## D

Date and Time • 99, 100  
Date/Time • 99, 128  
Default Connection Properties • 46, 48  
Default Shortcut Icons in the Main Toolbar • 122  
Deleting Backup Files • 90, 91  
Deleting KVM Switches • 31  
Disconnecting from a Virtual Media Drive • 67  
Dual Mouse Modes • 52, 53

## E

Editing KVM Switches • 14, 29, 30, 35, 63, 65, 133  
Editing or Deleting Macros • 77  
Editing or Deleting User Groups • 87  
Editing or Deleting Users • 80, 84

Executing Macros • 75, 76  
Exporting and Importing Backup Files • 89, 90

## F

Factory Reset • 92  
Fit window to Target • 71  
Front View • 4, 121, 122  
Full Screen Mode • 72

## G

General • 102, 103  
Getting Started • 11

## H

Hardware • 120, 121  
Hot Keys for Controlling User Station Windows • 10, 138

## I

Identifying States of KVM Switches and Ports • 35, 39, 40  
Input • 121, 122  
Installation and Configuration • 11  
Introduction • 1  
Introduction to the Software • 6  
Introduction to the User Station • 4  
Invalid Hot Keys for Port Access • 33  
IPv4 Settings • 22, 112, 113  
IPv6 Settings • 22, 113, 117

## K

Keyboard • 102, 123  
Keyboard Layout Icon • 9, 123  
Keyboard Macro Example • 76, 77  
Keyboard Macros • 50, 74, 77, 135  
Keyboard Options • 105  
Keyboard/Hot Key Settings • 50  
KVM Client Settings • 72, 79

## L

Layouts • 102, 104  
Location and Clock Time Format • 126, 127  
Login Screen • 6, 130  
Logout or Shutdown • 23

## M

- Main Screen and Main Toolbar • 8, 13, 104, 106, 110, 122
- Managing KVM Switches and Ports • 27
- Monitors • 9, 55, 109
- Mounting CD-ROM/DVD-ROM/ISO Images • 66
- Mounting Local Drives • 64
- Mouse Keys • 102, 108, 131
- Mouse Settings • 51
- Mouse Synchronization Tips • 52, 55

## N

- Navigation and Access to KVM Ports • 36
- Network Connections • 21, 111, 125
- Network Icon • 9, 96, 111, 113, 115, 118, 123
- Noise Filter • 47, 50
- Number of Supported Virtual Media Drives • 68

## O

- Online Help and Hot Keys Help • 10, 139
- Output • 121, 122
- Overview • 1, 11, 37

## P

- Package Contents • 2
- Password Change • 13, 80
- Port Data Retrieval Status • 32, 34, 42
- Port Navigator • 15, 33, 38
- Power Control • 70
- Prerequisites for Using Virtual Media • 63
- Privileges • 82, 85, 86, 87, 133
- Product Features • 2
- Product Photos • 3
- Product Photos and Features • 2

## R

- Rackmount Using L-type Brackets (Optional) • 25
- Rear View • 5, 121, 122

## S

- Scale Video • 72, 80

- Scenarios When Read/Write is Unavailable • 65
- Screen and Keyboard Settings in the Login Screen • 7, 130
- Setting User Preferences • 28, 74
- Show Window Decorations • 72, 80
- Side View • 5
- Single Mouse Cursor • 52, 55
- Software Update • 94
- Sound Preferences • 78, 120, 123
- Specification • 132
- Standard Mouse Mode • 55
- Step 1
  - Connect the Equipment • 11
- Step 2
  - Log in to the Dominion User Station • 6, 12
- Step 3
  - Add KX III KVM Switches • 13, 28, 29
- Step 4
  - Access KVM Switches and KVM Ports • 15, 38
- Step 5
  - Use the KVM Client • 18
- Support • 95
- Supported Virtual Media Types • 63, 64
- Synchronize Mouse • 52, 54
- System Settings • 98

## T

- Text Readability • 46, 49
- Time Zone • 99, 101
- Typing Break • 102, 109

## U

- USB Profile Overview • 61, 62
- USB Settings • 61, 64
- User Groups • 84, 85, 88
- User Station Configuration • 27, 29, 74, 78, 79, 80, 82, 86, 89, 92, 94, 95, 96
- Users • 82, 85, 88
- Using Filters • 16, 39, 43
- Using Search • 39, 42
- Using the KVM Client • 20, 45, 76

## V

- VESA Mount (Optional) • 23
- Video Mode • 47, 49
- Video Settings • 56

View Settings • 71  
Virtual Media • 2, 61, 63  
Virtual Media CIMs • 53, 64, 68  
Volume Icon • 9, 123

▶ **U.S./Canada/Latin America**

Monday - Friday  
8 a.m. - 6 p.m. ET  
Phone: 800-724-8090 or 732-764-8886  
For CommandCenter NOC: Press 6, then Press 1  
For CommandCenter Secure Gateway: Press 6, then Press 2  
Fax: 732-764-8887  
Email for CommandCenter NOC: tech-ccnoc@raritan.com  
Email for all other products: tech@raritan.com

▶ **China**

**Beijing**

Monday - Friday  
9 a.m. - 6 p.m. local time  
Phone: +86-10-88091890

**Shanghai**

Monday - Friday  
9 a.m. - 6 p.m. local time  
Phone: +86-21-5425-2499

**GuangZhou**

Monday - Friday  
9 a.m. - 6 p.m. local time  
Phone: +86-20-8755-5561

▶ **India**

Monday - Friday  
9 a.m. - 6 p.m. local time  
Phone: +91-124-410-7881

▶ **Japan**

Monday - Friday  
9:30 a.m. - 5:30 p.m. local time  
Phone: +81-3-5795-3170  
Email: support.japan@raritan.com

▶ **Europe**

**Europe**

Monday - Friday  
8:30 a.m. - 5 p.m. GMT+1 CET  
Phone: +31-10-2844040  
Email: tech.europe@raritan.com

**United Kingdom**

Monday - Friday  
8:30 a.m. to 5 p.m. GMT  
Phone +44(0)20-7090-1390

**France**

Monday - Friday  
8:30 a.m. - 5 p.m. GMT+1 CET  
Phone: +33-1-47-56-20-39

**Germany**

Monday - Friday  
8:30 a.m. - 5:30 p.m. GMT+1 CET  
Phone: +49-20-17-47-98-0  
Email: rg-support@raritan.com

▶ **Melbourne, Australia**

Monday - Friday  
9:00 a.m. - 6 p.m. local time  
Phone: +61-3-9866-6887

▶ **Taiwan**

Monday - Friday  
9 a.m. - 6 p.m. GMT -5 Standard -4 Daylight  
Phone: +886-2-8919-1333  
Email: support.apac@raritan.com