

# Cascading Guide

---

Release 3.4.0

## Safety Guidelines

**WARNING!** Read and understand all sections in this guide before installing or operating this product.

**WARNING!** Connect this product to an AC power source whose voltage is within the range specified on the product's nameplate. Operating this product outside the nameplate voltage range may result in electric shock, fire, personal injury and death.

**WARNING!** Connect this product to an AC power source that is current limited by a suitably rated fuse or circuit breaker in accordance with national and local electrical codes. Operating this product without proper current limiting may result in electric shock, fire, personal injury and death.

**WARNING!** Connect this product to a protective earth ground. Never use a "ground lift adaptor" between the product's plug and the wall receptacle. Failure to connect to a protective earth ground may result in electric shock, fire, personal injury and death.

**WARNING!** This product contains no user serviceable parts. Do not open, alter or disassemble this product. All servicing must be performed by qualified personnel. Disconnect power before servicing this product. Failure to comply with this warning may result in electric shock, personal injury and death.

**WARNING!** Use this product in a dry location. Failure to use this product in a dry location may result in electric shock, personal injury and death.

**WARNING!** Do not rely on this product's receptacle lamps, receptacle relay switches or any other receptacle power on/off indicator to determine whether power is being supplied to a receptacle. Unplug a device connected to this product before performing repair, maintenance or service on the device. Failure to unplug a device before servicing it may result in electric shock, fire, personal injury and death.

**WARNING!** Only use this product to power information technology equipment that has a UL/IEC 60950-1 or equivalent rating. Attempting to power non-rated devices may result in electric shock, fire, personal injury and death.

**WARNING!** Do not use a Raritan product containing outlet relays to power large inductive loads such as motors or compressors. Attempting to power a large inductive load may result in damage to the relay.

**WARNING!** Do not use this product to power critical patient care equipment, fire or smoke alarm systems. Use of this product to power such equipment may result in personal injury and death.

**WARNING!** If this product is a model that requires assembly of its line cord or plug, all such assembly must be performed by a licensed electrician and the line cord or plugs used must be suitably rated based on the product's nameplate ratings and national and local electrical codes. Assembly by unlicensed electricians or failure to use suitably rated line cords or plugs may result in electric shock, fire, personal injury or death.

**WARNING!** This product contains a chemical known to the State of California to cause cancer, birth defects, or other reproductive harm.

# Safety Instructions

1. Installation of this product should only be performed by a person who has knowledge and experience with electric power.
2. Make sure the line cord is disconnected from power before physically mounting or moving the location of this product.
3. This product is designed to be used within an electronic equipment rack. The metal case of this product is electrically bonded to the line cord ground wire. A threaded grounding point on the case may be used as an additional means of protectively grounding this product and the rack.
4. Examine the branch circuit receptacle that will supply electric power to this product. Make sure the receptacle's power lines, neutral and protective earth ground pins are wired correctly and are the correct voltage and phase. Make sure the branch circuit receptacle is protected by a suitably rated fuse or circuit breaker.
5. If the product is a model that contains receptacles that can be switched on/off, electric power may still be present at a receptacle even when it is switched off.

---

*Tip 1: The outlet (socket) shall be installed near the equipment and shall be easily accessible.*

---

*Tip 2: For detailed information on any Raritan PDU's overcurrent protectors' design, refer to that model's product specification on Raritan website's **PDU Product Selector page** <https://www.raritan.com/product-selector>.*

---

This document contains proprietary information that is protected by copyright. All rights reserved. No part of this document may be photocopied, reproduced, or translated into another language without express prior written consent of Raritan, Inc.

© Copyright 2018 Raritan, Inc. All third-party software and hardware mentioned in this document are registered trademarks or trademarks of and are the property of their respective holders.

#### FCC Information

This equipment has been tested and found to comply with the limits for a Class A digital device, pursuant to Part 15 of the FCC Rules. These limits are designed to provide reasonable protection against harmful interference in a commercial installation. This equipment generates, uses, and can radiate radio frequency energy and if not installed and used in accordance with the instructions, may cause harmful interference to radio communications. Operation of this equipment in a residential environment may cause harmful interference.

#### VCCI Information (Japan)

この装置は、クラスA情報技術装置です。この装置を家庭環境で使用すると電波妨害を引き起こすことがあります。この場合には使用者が適切な対策を講ずるよう要求されることがあります。 VCCI-A

Raritan is not responsible for damage to this product resulting from accident, disaster, misuse, abuse, non-Raritan modification of the product, or other events outside of Raritan's reasonable control or not arising under normal operating conditions.

If a power cable is included with this product, it must be used exclusively for this product.



### Warning

This is a class A product. In a domestic environment this product may cause radio interference in which case the user may be required to take adequate measures.

### CAUTION:



To reduce the risk of shock — Use indoors only in a dry location. No user serviceable parts inside. Refer servicing to qualified personnel. For use with IT equipment only. Disconnect power before servicing.



SecureLock™

# Contents

Safety Guidelines	ii
<hr/>	
Safety Instructions	iii
<hr/>	
Applicable Products	ix
<hr/>	
What's New in the Cascading Guide	x
<hr/>	
<b>Chapter 1 Cascading Solution's Overview</b>	<b>1</b>
<hr/>	
Cascading Applications .....	1
Illustration.....	2
Best Practices .....	3
When to Avoid Cascading Devices.....	4
Cascading Procedure .....	4
<hr/>	
<b>Chapter 2 Cascading Modes</b>	<b>6</b>
<hr/>	
Overview of the Cascading Modes.....	6
Setting the Cascading Mode.....	8
Mode Change via Web Interface .....	8
Mode Change via CLI.....	10
<hr/>	
<b>Chapter 3 Cascading Raritan Devices</b>	<b>12</b>
<hr/>	
USB Cascading .....	12
USB-Cascading Requirements.....	13
Cascading Raritan devices via USB .....	14
Extended Cascading (for iX7™ Devices Only).....	16
Extended-Cascading Requirements.....	16
Cascading iX7™ Devices via Ethernet or USB .....	18
Cascading Restrictions.....	20
<hr/>	
<b>Chapter 4 Accessing Raritan Devices</b>	<b>22</b>
<hr/>	
Finding the IP Address .....	22
LCD Display .....	22

Local Console.....	26
MAC Address.....	27
HTTP/HTTPS Access .....	27
Supported Web Browsers .....	27
Login.....	27
SSH/Telnet Access .....	28
SNMP Management.....	29
SNMP Notifications.....	29
Third-Party SNMP Managers .....	29
Port Numbers for Port-Forwarding Devices .....	30
Port Number Syntax .....	30
Port Forwarding Examples.....	32
<b>Chapter 5 Identifying Cascaded Devices</b>	<b>35</b>
Using the Web Interface.....	35
Using the CLI .....	38
Using the SNMP.....	40
Using the LCD Display .....	42
Dot-Matrix LCD Display .....	42
Character LCD Display.....	45
<b>Chapter 6 Adding, Removing or Swapping Cascaded Devices</b>	<b>47</b>
<b>Chapter 7 Firmware Upgrade</b>	<b>49</b>
Updating the Raritan device Firmware .....	49
Upgrade Sequence in an Existing Cascading Chain .....	50
<b>Appendix A Unsupported Cascading Connections for Port Forwarding</b>	<b>52</b>
<b>Appendix B Cascading Troubleshooting</b>	<b>55</b>
Possible Root Causes.....	55
Slave Device Events in the Log.....	58
The Ping Tool.....	58
Ping via the Web Interface .....	59
Ping via the CLI .....	60

<b>Appendix C Additional Information</b>	<b>62</b>
Connecting the Raritan device to a Computer .....	62
Making a Connection.....	62
Installing the USB-to-Serial Driver (Optional) .....	63
Configuring Network Settings.....	64
Configuration via Web Interface .....	65
Configuration via CLI.....	66
Wireless LAN Information.....	71
Supported Wireless LAN Configuration .....	71
USB Wireless LAN Adapters.....	71
<b>Index</b>	<b>73</b>



# Applicable Products

This guide is applicable to the following Raritan products.

- PX2 series power distribution units (PDUs)
- PX3 series PDUs, including PX3-iX7
- EMX asset management devices
- PX3TS transfer switches
- Branch Circuit Monitor 1 (BCM1)
- Branch Circuit Monitor 2 (BCM2), including PMC and PMMC models

# What's New in the Cascading Guide

**Warning:** Firmware version 3.3.10 or later is NOT compatible with pre-3.3.10 firmware versions in terms of the cascading feature so all devices in the cascading chain must run version 3.3.10 or later. Otherwise, a networking issue occurs.

To upgrade an existing USB-cascading chain from a firmware version older than 3.3.10, you must start from the last slave device and so on until the master device. Otherwise, a networking issue occurs. See *Upgrade Sequence in an Existing Cascading Chain* (on page 50).

The following sections have changed or information has been added to the Cascading Guide based on changes and enhancements to the Raritan software, hardware, and/or user documentation.

- *Applicable Products* (on page ix)
- *Best Practices* (on page 3)
- *Overview of the Cascading Modes* (on page 6)
- *Setting the Cascading Mode* (on page 8)
- *Mode Change via Web Interface* (on page 8)
- *Cascading Raritan Devices* (on page 12)
- *USB Cascading* (on page 12)
- *USB-Cascading Requirements* (on page 13)
- *Cascading Raritan devices via USB* (on page 14)
- *Extended Cascading for iX7<sup>®</sup> Devices Only* (see "Extended Cascading (for iX7<sup>™</sup> Devices Only)" on page 16)
- *Extended-Cascading Requirements* (on page 16)
- *Cascading iX7<sup>®</sup> Devices via Ethernet or USB* (on page 18)
- *Cascading Restrictions* (on page 20)
- *Finding the IP Address* (on page 22)
- *Dot-Matrix LCD Display* (on page 23)
- *Upgrade Sequence in an Existing Cascading Chain* (on page 50)
- *Possible Root Causes* (on page 55)

# Chapter 1 Cascading Solution's Overview

In this guide, iX7™ devices refer to any Raritan product with the iX7™ controller, including PX3-iX7 PDUs and PX3TS-iX7 transfer switches.

Raritan provides a cascading solution, which enables multiple Raritan devices to share the network connectivity by cascading them through the USB or Ethernet interface.

You can access and administer each device in the cascading chain over the Internet from anywhere via various protocols -- HTTP(S), SNMP, SSH, Telnet and Modbus. Besides, each device can be upgraded respectively.

For documentation purposes, the first device in the cascading chain is called the 'master' device and the others are called 'slave' devices.

## In This Chapter

Cascading Applications .....	1
When to Avoid Cascading Devices.....	4
Cascading Procedure .....	4

---

## Cascading Applications

To reduce the number of Ethernet connections or save networking costs in your data center, you can apply the cascading solution.

---

### Illustration

In a cascading chain, all Raritan devices are cascaded via USB or Ethernet, and only the master device is connected to the LAN.

The following diagrams illustrate different cascading scenarios using Zero U PDUs. Red lines in the diagrams represent the cascading connections, which are either USB or standard network patch cables.

- ▶ **Scenario 1: Cabinet 1 has four PDUs cascaded, sharing one Ethernet connection.**

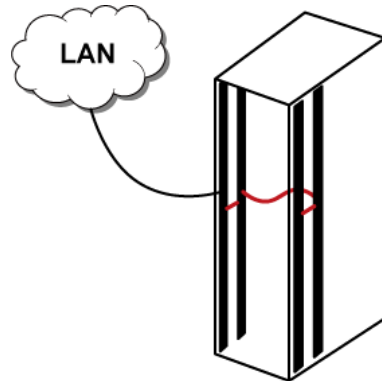

- ▶ **Scenario 2: Cabinet 1 and Cabinet 2 have four PDUs respectively.**  
The eight PDUs are cascaded, sharing one Ethernet connection.

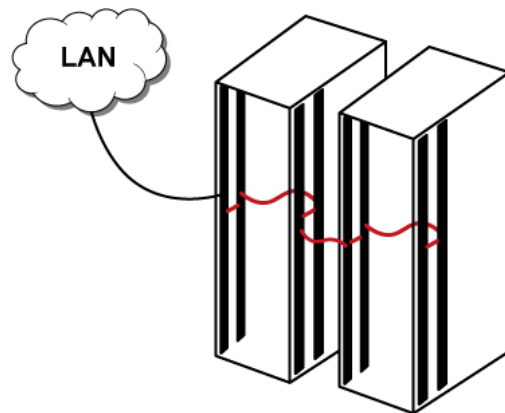

- ▶ **Scenario 3: Cabinet 1 through Cabinet 4 have four PDUs respectively.**  
The 16 PDUs are cascaded, sharing one Ethernet connection.

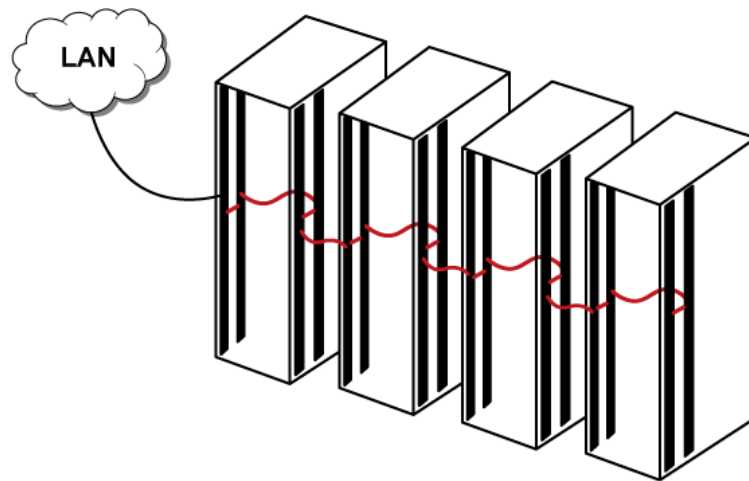

---

### Best Practices

▶ **One Ethernet connection per cabinet is better:**

One Ethernet connection per cabinet is better than one Ethernet connection across cabinets because of these advantages:

- Easier to manage or maintain one cabinet when all of the cabling and connections are located in the same cabinet.
- Reduces the cross-cabinet cabling.

▶ **When to establish a chain comprising 16 devices:**

A chain consisting of 16 devices saves the most Ethernet connections and costs, and it is recommended only when:

- External Ethernet ports are expensive or limited.
- Available IP addresses are limited.

▶ **Ethernet cascading is recommended for PX3-iX7 and PX3TS-iX7:**

If your Raritan products are PX3-iX7 PDUs or PX3TS-iX7 transfer switches, cascading them via Ethernet is better than via USB because the Ethernet interface offers the following benefits.

- Longer cabling distance
- Lower latency
- Connection more reliable with RJ-45 connectors

See *Extended Cascading (for iX7<sup>®</sup> Devices Only)* (on page 16).

---

## When to Avoid Cascading Devices

There are two scenarios where the cascading solution is NOT recommended.

▶ **High network reliability is required:**

The cascading solution increases the number of network bridging points for cascaded devices, which may result in network unreliability. Therefore, when high network reliability is required, establish a separate network connection for each Raritan device to minimize the number of potential network failure points.

▶ **High bandwidth is required:**

The bandwidth among cascaded devices is limited by the USB or Ethernet interface where they are connected. When high bandwidth is required, such as transmission of webcam videos, it is strongly recommended to directly connect that Raritan device to the network to optimize the data transfer rate.

**The maximum bandwidth supported by each interface:**

- *USB:* 12 or 480 Mbps, half duplex.
  - 12 Mbps (half duplex) when both or either side supports full-speed USB only.
  - 480 Mbps (half duplex) when both cascaded devices are iX7™ devices, which support high-speed USB.
- *Ethernet:* 100 Mbps, full duplex.

---

*Note: Effective throughput may be lower than the rate listed due to protocol overhead.*

---

---

## Cascading Procedure

Since firmware version 3.3.10, you must follow the steps below to establish a cascading chain.

---

**Warning: Networking issues occur if the following steps are reversed.**

---

▶ **Main cascading procedure:**

1. Log in to each Raritan device and configure the cascading mode.  
Refer to:
  - *Setting the Cascading Mode* (on page 8).
2. Cascade all devices.

Refer to:

- *Cascading Raritan devices via USB* (on page 14)
- *Cascading iX7<sup>®</sup> Devices via Ethernet or USB* (on page 18)

## Chapter 2 Cascading Modes

You must apply a cascading mode to a cascading chain.

The cascading mode determines how each device in the chain is accessed.

### In This Chapter

Overview of the Cascading Modes.....	6
Setting the Cascading Mode.....	8

---

### Overview of the Cascading Modes

There are two cascading modes: Bridging and Port Forwarding.

In the following illustration, it is assumed that users enable the DHCP networking for the cascading chain comprising four devices. In the diagrams, "M" is the master device and "S" is a slave device.

► **Illustration:**

- "Bridging" mode:

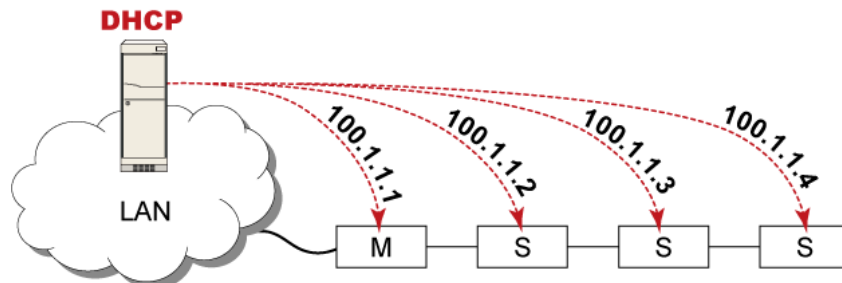

In this mode, the DHCP server communicates with every cascaded device respectively and assigns four *different* IP addresses. Each device has its own IP address.

The way to remotely access each cascaded device is completely the same as accessing a standalone device in the network.



- "Port Forwarding" mode:

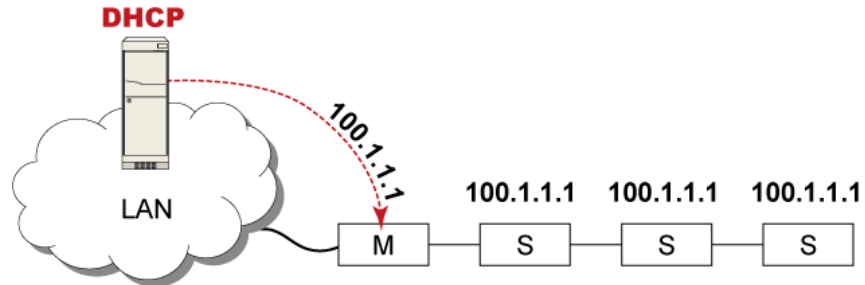

In this mode, the DHCP server communicates with the master device alone and assigns one IP address to the master device. All slave devices share the same IP address as the master device.

You must specify a 5XXXX port number (where X is a number) when remotely accessing any slave device with the shared IP address. See *Port Number Syntax* (on page 30).

► **Comparison between cascading modes:**

- The Bridging mode supports the wired network only, while the Port Forwarding mode supports both wired and wireless networks.
- Both cascading modes support a maximum of 16 devices in a chain.
- Both cascading modes support both DHCP and static IP addressing.
- In the Bridging mode, each cascaded device has a unique IP address. In the Port Forwarding mode, all cascaded devices share the same IP address(es) as the master device.
- In the Bridging mode, each cascaded device has only one IP address. In the Port Forwarding mode, each cascaded device can have multiple IP addresses as long as the master device has multiple network interfaces enabled/configured properly.

For example:

- If the master device is a non-iX7 product, you can enable the ETHERNET and WIRELESS interfaces so that the Port-Forwarding chain has one wired IP address and one wireless IP address.
- If the master device is an iX7™ product, you can enable ETH1, ETH2 and WIRELESS interfaces so that the Port-Forwarding chain has two wired IP addresses and one wireless IP address.

---

## Setting the Cascading Mode

The cascading mode of all devices in the chain must be the same.

---

**Warning: If any slave device's cascading mode is different from the master device's, a networking failure occurs on that one and the subsequent slave devices.**

---

The cascading mode can be configured via the web interface or command line interface (CLI).

Only a user with the Change Network Settings permission can configure the cascading mode.

---

### Mode Change via Web Interface

Repeat the following procedure for each device you want to cascade until all devices share the same cascading mode.

► **To set the cascading mode via the Web interface:**

1. Connect the Raritan device to the LAN and find its IP address, or connect it to a computer.
  - For computer connection instructions, see *Connecting the Raritan device to a Computer* (on page 62).
  - To find the IP address, see *Finding the IP Address* (on page 22).
2. Log in to its web interface. See *Login* (on page 27).
3. Choose Device Settings > Network.
4. Select the preferred mode in the Cascading Mode field.

Mode	Description
None	No cascading mode is enabled. This is the default.
Bridging	Each device in the cascading chain is accessed with a different IP address.
Port Forwarding	Each device in the cascading chain is accessed with the same IP address(es) but with a different port number assigned. For details on port numbers, see <i>Port Number Syntax</i> (on page 30).

---

*Tip: If selecting Port Forwarding, the Device Information page will show a list of port numbers for all cascaded devices. Simply choose Maintenance > Device Information > Port Forwarding.*

---

- For the Port Forwarding mode, one to two more fields have to be configured.

Note that if either setting below is incorrectly configured, a networking issue occurs.

Field	Description
<b>Role</b> (available on all cascaded devices)	<i>Master or Slave.</i> This is to determine which device is the master and which ones are slave devices.
<b>Downstream interface</b> (available on the maser device only)	<i>USB or ETHERNET (or ETH1/ETH2).</i> This is to determine which port on the master device is connected to Slave 1. Always select 'USB' for NON-PX3-iX7 product models, but you can select either 'USB' or 'ETH1/ETH2' for PX3-iX7 PDUs.  If ETH1 or ETH2 is selected, make sure the selected Ethernet interface is enabled.

- (Optional) Configure the network settings by clicking the BRIDGE, ETHERNET (or ETH1/ETH2), or WIRELESS section on the same page.
  - In the Bridging mode, each cascaded device can have different network settings. You may need to configure each device's network settings in the BRIDGE section.
  - In the Port Forwarding mode, all cascaded devices share the master device's network settings. You only need to configure the master device's network settings in the ETHERNET (or ETH1/ETH2) and/or WIRELESS section.

See **Configuration via Web Interface** (on page 65).

---

*Tip: You can enable/configure multiple network interfaces in the Port Forwarding mode so that the cascading chain has multiple IP addresses.*

---

- Click Save.

---

### Mode Change via CLI

Repeat the following procedure for each device you want to cascade until all devices share the same cascading mode.

► **To set the cascading mode via CLI:**

1. Connect the Raritan device to the LAN and find its IP address, or connect it to a computer.
2. Log in to its CLI.
  - To use the SSH or Telnet service, see *SSH/Telnet Access* (on page 28).
3. Type `config` and press Enter to enter the configuration mode.
4. Type the following command to set the cascading mode.

```
config:# network <mode> enabled <option1>
```

*Variables:*

- <mode> is one of the following cascading modes.

Mode	Description
bridge	The Bridging mode, where each cascaded device is assigned a unique IP address.
portForwarding	The Port Forwarding mode, where every cascaded device in the chain shares the same IP address, with diverse port numbers assigned.

---

**Important: When enabling either cascading mode, you must make sure the other cascading mode is disabled, or the preferred cascading mode may not be enabled successfully.**

---

- <option1> is one of the following options:

Option	Description
true	The selected cascading mode is enabled.
false	The selected cascading mode is disabled.

- ▶ **If Port Forwarding mode is enabled, you must configure two more settings to finish the configuration:**

On ALL cascaded devices, you must configure the 'role' setting one by one.

```
config:# network portForwarding role <option2>
```

On the master device, you must configure the 'downstream interface' setting.

```
config:# network portForwarding
        masterDownstreamInterface <option3>
```

*Variables:*

- <option2> is one of the following cascading roles:

Role	Description
master	The device is a master device.
slave	The device is a slave device.

- <option3> is one of the following options:

Option	Description
Ethernet (or ETH1/ETH2)	Ethernet (or ETH1/ETH2) port is the port where the 1st slave device is connected.
Usb	USB port is the port where the 1st slave device is connected.

# Chapter 3 Cascading Raritan Devices

In this guide, iX7™ devices refer to any Raritan product with the iX7™ controller, including PX3-iX7 PDUs and PX3TS-iX7 transfer switches.

There are two cascading methods.

- *USB cascading:* All devices in the chain are cascaded via USB ports. All Raritan products described in this guide support this cascading method.
- *Extended cascading:* All devices in the chain are cascaded via either USB or Ethernet ports. Only iX7™ devices support this cascading method.

## In This Chapter

USB Cascading.....	12
Extended Cascading (for iX7™ Devices Only) .....	16
Cascading Restrictions.....	20

---

## USB Cascading

All Raritan devices described in this guide support full-speed USB, which transfers data at a maximum rate of 12 Mbps.

iX7™ devices support high-speed USB so they can transfer data at a rate up to 480 Mbps. PMMC also supports high-speed USB because it is an iX7-based device.

USB communication is always half duplex.

Note that the USB bandwidth between the master and the first slave device will limit the actual data transfer rate between all USB-cascaded slave devices.

---

*Tip: If two or more iX7 devices are involved in a USB-cascading chain, you can set them as the master and the first several slave devices for optimal data transmission.*

---

The distance between two USB-cascaded devices CANNOT exceed 5 meters (16 feet).



## USB-Cascading Requirements

The USB-cascading chain comprises either identical or diverse Raritan products. For example, you can cascade PX2 PDUs only, or you can mix PX2, PX3, EMX, PX3TS and BCM devices in a USB-cascading chain.

### ▶ Hardware requirements:

- The USB-cascading chain must consist of the following Raritan products.

Raritan products	Number of USB-A ports
PX2 series PDUs	1
PX3 series PDUs, including PX3-iX7	2
EMX devices	1
PX3TS transfer switches, including PX3TS-iX7	2
BCM1	1
BCM2	2
PMC	2
PMMC	1

- If wireless networking is wanted, the master device must be a product with two USB-A ports.

### ▶ Software requirements:

- Firmware version 3.3.10 or later is NOT compatible with pre-3.3.10 firmware versions in terms of the cascading feature so all devices in the cascading chain must run version 3.3.10 or later.
- You can also choose to have the USB-cascading chain run any pre-3.3.10 firmware. The disadvantage is that a pre-3.3.10 firmware version supports a maximum of 8 cascaded devices rather than 16.

Check firmware versions before cascading Raritan devices and upgrade any device as needed.

**Warning:** To upgrade an existing USB-cascading chain from a firmware version older than 3.3.10, you must start from the last slave device and so on until the master device. Otherwise, a networking issue occurs. See *Upgrade Sequence in an Existing Cascading Chain* (on page 50).

---

### Cascading Raritan devices via USB

Any certified USB 2.0 cable up to 5 meters (16 feet) long can be used.

For a list of Raritan products supporting the USB-cascading feature, see *USB-Cascading Requirements* (on page 13).

You must set the cascading mode before establishing the chain. See *Setting the Cascading Mode* (on page 8).

---

*Tip: If your Raritan products are iX7™ devices, you can cascade them via either USB or Ethernet. See **Cascading iX7™ Devices via Ethernet or USB** (on page 18).*

---

The following illustrates a USB-cascading chain.

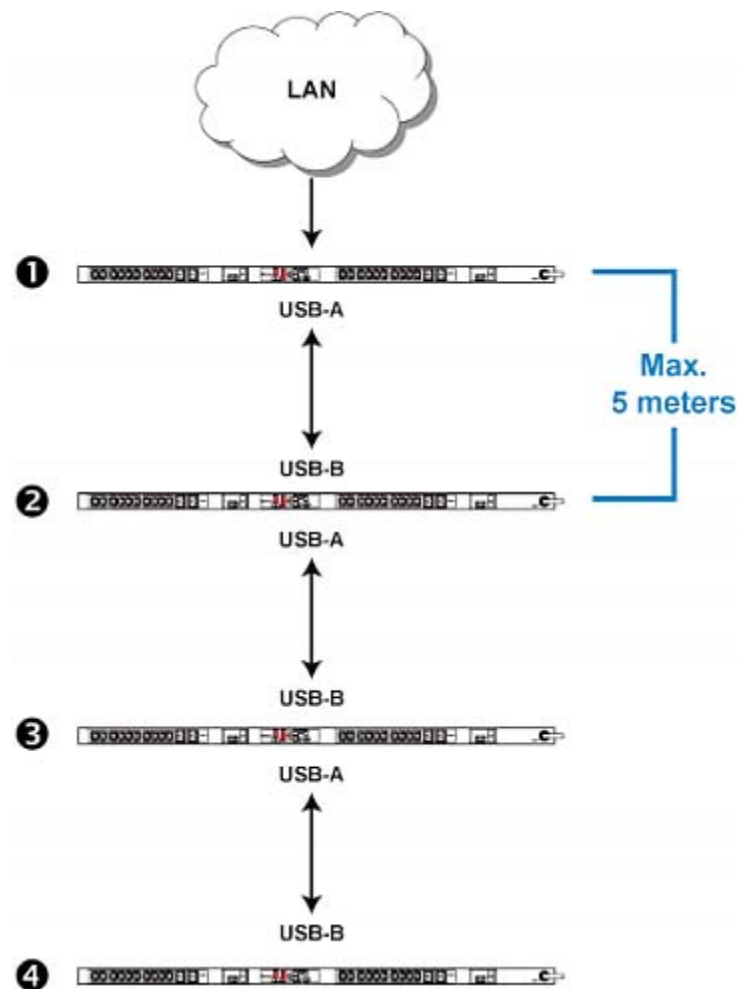



Number	Device role
①	Master device
②	Slave 1
③	Slave 2
④	Slave 3

► **To cascade Raritan devices:**

1. Make sure all Raritan devices are running firmware version 3.3.10 or later.

---

*Important: To upgrade an existing USB-cascading chain from any pre-3.3.10 firmware version to version 3.3.10 or later, follow the **Upgrade Sequence in an Existing Cascading Chain** (on page 50).*

---

2. Make sure all devices share the same cascading mode.
3. Choose the appropriate one as the master device.
4. Connect the master device to the LAN, using a method below.
  - **Bridging mode:**  
Use a standard network patch cable (CAT5e or higher).
  - **Port Forwarding mode:**  
Use a standard network patch cable and/or a Raritan USB WIFI wireless LAN adapter. For information on the Raritan USB WIFI adapter, see ***USB Wireless LAN Adapters*** (on page 71).
5. Connect the USB-A port of the master device to the USB-B port of an additional Raritan device via a USB cable. This additional device is Slave 1.
6. Connect Slave 1's USB-A port to the USB-B port of an additional Raritan device via another USB cable. The second additional device is Slave 2.
7. Repeat the same step to connect more slave devices. You can cascade up to 15 slave devices.

## Extended Cascading (for iX7™ Devices Only)

Extended cascading can be made via USB or Ethernet interfaces on iX7™ devices. iX7™ devices support high-speed USB so they can transfer data at a rate up to 480 Mbps.

The following is the comparison between the two interfaces of an iX7™ device.

Item	Maximum rate or distance
Data transfer rate	<ul style="list-style-type: none"> <li>▪ <i>USB</i>: 480 Mbps (half duplex)</li> <li>▪ <i>Ethernet</i>: 100 Mbps (full duplex)</li> </ul>
Cabling distance between two cascaded devices	<ul style="list-style-type: none"> <li>▪ <i>USB</i>: 5 meters (16 feet)</li> <li>▪ <i>Ethernet</i>: 100 meters (328 feet)</li> </ul>

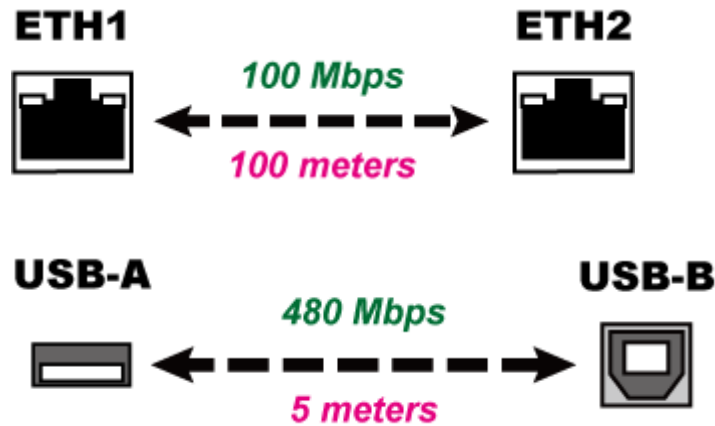

### Extended-Cascading Requirements

The extended-cascading chain must meet these requirements.

► **Hardware requirements:**

- All cascaded devices are iX7™ devices, including PX3-iX7 and PX3TS-iX7.

Only these devices support extended cascading because they have dual USB-A ports and dual Ethernet ports -- ETH1 and ETH2.

---

*Note: PMMC does not support extended cascading because it does not have two Ethernet ports.*

---

▶ **Software requirements:**

- All cascaded devices must run firmware version 3.3.10 or later. This is because 'Ethernet' cascading is supported as of release 3.3.10.

---

### Cascading iX7™ Devices via Ethernet or USB

Though iX7™ devices support both USB- and Ethernet-cascading connections, Ethernet cascading is recommended because of the longer distance, lower latency and more reliable connection it supports.

You can use either Ethernet port on the iX7™ device for cascading.

The 'green' ETH1 port (ETH⑩10/100/1000) of the master device is recommended for network connection because it supports up to 1000 Mbps.

You must set the cascading mode before establishing the chain. See ***Setting the Cascading Mode*** (on page 8).

When establishing a Port-Forwarding chain, make sure you follow the guidelines described in the section titled ***Unsupported Cascading Connections for Port Forwarding*** (on page 52).

You can mix Ethernet and USB cascading in an iX7™ chain if preferred. The following diagram illustrates such a chain.

---

*Note: The following diagram illustrates PX3-iX7 Zero U PDUs, but the same procedure also applies to other Raritan iX7™ products.*

---

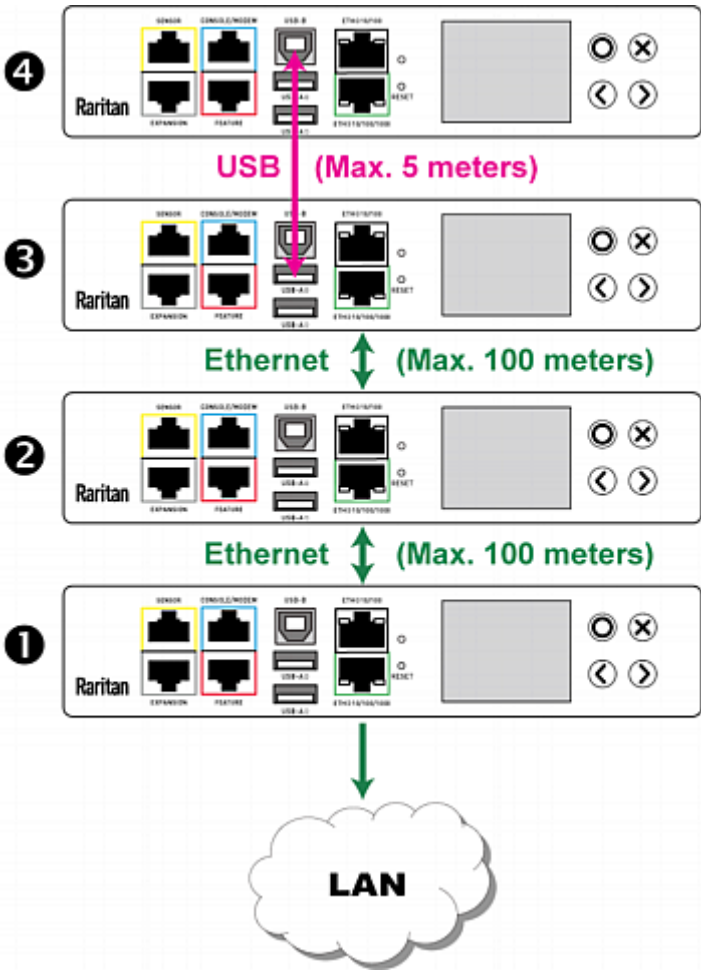

Number	Device role
①	Master device
②	Slave 1
③	Slave 2
④	Slave 3

For instructions on USB cascading, see *Cascading Raritan devices via USB* (on page 14).

► **To cascade iX7™ devices via Ethernet ports:**

1. Make sure all Raritan devices are running firmware version 3.3.10 or later.
2. Make sure all devices share the same cascading mode.
3. Choose an appropriate iX7™ device as the master device.

4. Connect the master device to the LAN, using a method below.
    - **Bridging mode:**  
Use a standard network patch cable (CAT5e or higher).
    - **Port Forwarding mode:**  
Use a standard network patch cable and/or a Raritan USB WIFI wireless LAN adapter. For information on the Raritan USB WIFI adapter, see *USB Wireless LAN Adapters* (on page 71).
  5. Connect an available Ethernet port of the master device to either Ethernet port of another iX7™ device via a standard network patch cable. This additional iX7™ device is Slave 1.
  6. Connect Slave 1's available Ethernet port to either Ethernet port of another iX7™ device via a standard network patch cable. The second additional iX7™ device is Slave 2.
  7. Repeat the same step to connect more iX7™ slave devices. You can cascade up to 15 slave devices.
- ▶ **Enable R/STP if a cascade loop is preferred:**
- You can "loop" a cascading chain to create network communication redundancy (Bridging mode only), but only when your network supports R/STP protocol.  
Make sure that your network has R/STP enabled if using a cascade loop (Bridging mode) *or else network loops may occur.*

---

## Cascading Restrictions

- ▶ **General:**
- All devices in the chain must run "compatible" firmware versions. Note that firmware version 3.3.10 or later is NOT compatible with pre-3.3.10 firmware versions in terms of the cascading function.
    - **USB-cascading chain:**  
All devices must run firmware version 3.3.10 or later, or all run any firmware version earlier than 3.3.10.
    - **Extended-cascading chain:**  
All iX7™ devices must run firmware version 3.3.10 or later.

---

*Warning: To upgrade an existing USB-cascading chain from a firmware version older than 3.3.10, you must start from the last slave device and so on until the master device. Otherwise, a networking issue occurs. See **Upgrade Sequence in an Existing Cascading Chain** (on page 50).*

---

- The cascading mode of all devices in the chain must be the same.
- Both cascading modes support a maximum of 16 devices in a chain.
- Only the master device is connected to the LAN.  
Do NOT connect slave devices to the LAN via a standard network patch cable or a USB wireless LAN adapter.
- Appropriate networking methods vary based on the cascading mode. See ***Setting the Cascading Mode*** (on page 8).
  - The Bridging mode supports the *wired* networking only.
  - The Port Forwarding mode supports both the *wired* and *wireless* networking.
- Your network switch's port security settings must support the cascading solution. Make sure that packets forwarding is enabled for the "external" Ethernet port where the master device is connected.
- Plug-and-play is no longer supported as of release 3.3.10 so you CANNOT add, remove or swap cascaded devices in a chain randomly. For the appropriate procedure, see ***Adding, Removing or Swapping Cascaded Devices*** (on page 47).

► **Restrictions for the Bridging mode only:**

- In the Bridging mode, the master device can have "only one" connection to the network. If the master device is an iX7™ device with two Ethernet ports, DO NOT connect both ports to the network(s) unless your network has the R/STP protocol enabled.

---

*Note: The Port Forwarding mode does NOT have this restriction. In this mode, you can enable one wired and one wireless network connections for non-iX7 products, or enable two wired and one wireless network connections for iX7™ products.*

---

► **Restrictions for the "wireless" LAN (Port Forwarding mode):**

- You must use Raritan's USB WIFI wireless LAN adapter instead of other WIFI adapters for wireless network connection.
- No external USB hub is used with the master device.
- To establish a **USB-cascading** chain, the master device must be a Raritan product with two USB-A ports. This is because it requires one USB-A port to connect the USB wireless LAN adapter and the other to connect a slave device.

## Chapter 4 Accessing Raritan Devices

The master device functions as the network bridge and can transmit IP packets between the LAN and all slave devices connected to it. Therefore, you can remotely access the master and every slave device via the Web (http or https), SNMP, SSH, or Telnet interface.

### In This Chapter

Finding the IP Address .....	22
HTTP/HTTPS Access .....	27
SSH/Telnet Access .....	28
SNMP Management.....	29
Port Numbers for Port-Forwarding Devices .....	30

---

### Finding the IP Address

Before you can remotely access any Raritan device, you should first find its IP address(es).

There are three IP retrieval methods:

- Operate the front panel LCD display if the Raritan device is a PX3, PX3-iX7, PX3TS, PX3TS-iX7, BCM1, BCM2, PMC, PMMC, or EMX device.
- Access the local console.
- Use the device's MAC address and common networking tools.

---

#### LCD Display

Some Raritan products have a front panel LCD display which can show its networking information.

Depending on the Raritan product you purchased, the LCD display type varies.

- PX3, PX3-iX7, PX3TS-iX7, BCM2, PMC, and PMMC models have a dot-matrix LCD display.
- EMX, PX3TS, and BCM1 have a character LCD display.



### Dot-Matrix LCD Display

The dot-matrix LCD display can show both IPv4 and IPv6 networking information.



Note that the diagrams illustrated in this section are for Zero U PDUs, and your dot-matrix LCD display may look slightly different if it is on a different product model.

---





*Note: Your device's front panel data may look a little different from the following images if it is of a different Raritan product model.*

---

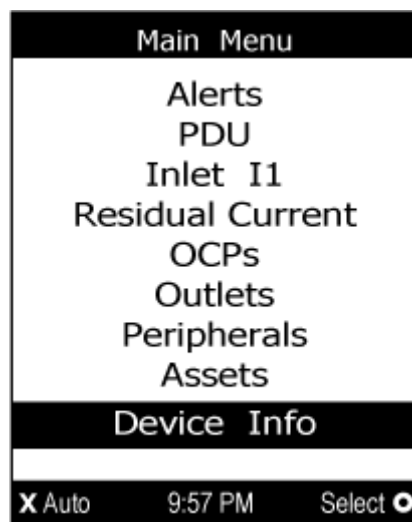
► **To retrieve the IPv4 and/or IPv6 addresses:**

1. If the LCD display is in the Automatic mode, exit it by pressing  or . The Main Menu similar to the following is displayed.



2. Press  or  to select "Device Info" in the Main Menu, and press .
3. Press  until IPv4 and/or IPv6 address(es) of the device are displayed.

The diagram illustrates the IP address screen in the 'Bridging' mode. For information on the Port Forwarding mode, see *Dot-Matrix LCD Display* (on page 42).

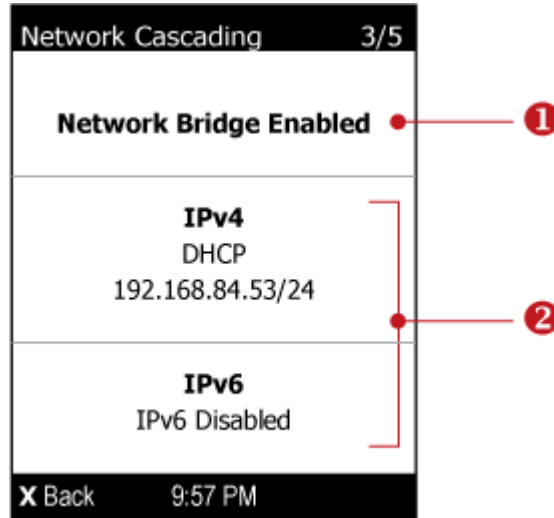

Number	Description
①	Current cascading mode. <ul style="list-style-type: none"> <li>In the above diagram, it shows the Bridging mode.</li> </ul>
②	IPv4/IPv6 network information, including: <ul style="list-style-type: none"> <li>Network configuration: DHCP (or Automatic), or Static. Static represents Static IP.</li> <li>The device's IP address.</li> <li>IPv4 or IPv6 prefix length (such as "/24").</li> </ul>

If you do not enable IPv4 or IPv6 settings, a message is displayed to indicate IPv4 or IPv6 is disabled.

### Character LCD Display

The IP address is available in the Device mode, which is indicated by the alphabet 'd' shown at the top of the LCD display. Note that this type of LCD display only shows the IPv4 address (if available).

Below illustrates the IP address information.

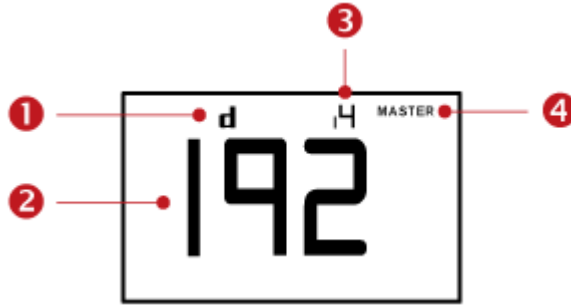

Section	Example information
①	"d" means the LCD display has entered the Device mode.
②	The LCD display is showing 192, which is one of the four IP address octets. It will cycle through four octets.
③	"i4" indicates that the IP address shown on the LCD display is an IPv4 address.
④	The word "MASTER" indicates the Raritan device is the master device in a cascading chain. For a slave device, it shows "SLAVE" instead.  <i>Note: As of release 3.3.10, the "MASTER/SLAVE" information is no longer available in the Bridging mode, but remains available in the Port Forwarding mode.</i>

If you connect your Raritan device to the wireless network, a Wi-Fi icon is displayed at the bottom-right corner.



► **To retrieve the "IPv4" address on Raritan device:**

1. Press the MODE button to enter the Device mode, indicated by an alphabet "d" at the top left of the display.
2. The LCD display cycles between the four octets of the IPv4 address, indicated by "i4" at the upper right corner of the display.

For example, 192.168.84.4 cycles in this sequence:

192 --> 168 --> 84 --> 4

---

### Local Console

The IP address of the master or slave device is available in each device's local console, which is the command line interface (CLI).

To access the local console, first connect the Raritan device to the computer using a serial RS-232 cable, and then use a terminal emulation program on the computer to access it.

You can also access a cascaded device's local console via a USB connection. For details, see the Quick Setup Guide, Online Help or User Guide, which can be downloaded from Raritan website's *Support page* (<http://www.raritan.com/support/>).

You can use any terminal emulation programs for local access to the command line interface.

This section illustrates HyperTerminal, which is part of Windows operating systems prior to Windows Vista.

► **To get the IP address using HyperTerminal:**

1. Connect your computer to the Raritan device via a local (USB or RS-232) connection.
2. Launch HyperTerminal on your computer and open a console window. When the window first opens, it is blank.

Make sure the COM port settings use this configuration:

- Bits per second = 115200 (115.2Kbps)
  - Data bits = 8
  - Stop bits = 1
  - Parity = None
  - Flow control = None
3. In the communications program, press Enter to send a carriage return to the Raritan device. Now you should see the Raritan device's IP address displayed in the terminal.

---

### MAC Address

A label is affixed to the Raritan device, showing both the serial number and MAC address.



If necessary, you can find its IP address through the MAC address by using commonly-used network tools. Contact your LAN administrator for assistance.

---

### HTTP/HTTPS Access

You can remotely access the web interface of any Raritan device in a cascading chain by using a web browser. See *Supported Web Browsers* (on page 27) for a list of supported web browsers.

---

### Supported Web Browsers

The following web browsers can be used to access a Raritan device's web interface. For details, see the online help or User Guide for your Raritan device.

- Internet Explorer®
- Windows Edge
- Firefox®
- Safari®
- Google® Chrome®
- Android
- IOS

---

### Login

You must enable JavaScript in the web browser for proper operation.

► **To log in to the web interface:**

1. Open a browser and type the IP address of the Raritan device.



---

*Note: The address to access a slave device in the Port Forwarding mode via non-standard ports is a combination of a protocol (<http://> or <https://>), an IP address and a port number. See **Port Forwarding Examples** (on page 32).*

---

2. If any security alert message appears, accept it.
3. The login screen displays. Type your user name and password. User credentials are case sensitive.

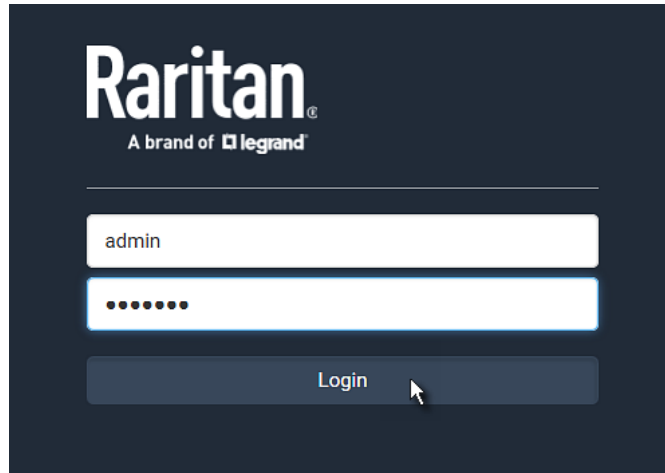

4. (Optional) If a security agreement is displayed, accept it. Otherwise, you cannot log in.
5. Click Login or press Enter. The Raritan device web interface opens.

---

## SSH/Telnet Access

All devices in the cascading chain support the SSH or Telnet service. You can remotely log in to the command line interface (CLI) using an SSH or Telnet client, such as PuTTY.

---

*Note: PuTTY is a free program you can download from the Internet. See PuTTY's documentation for details on configuration.*

---

► **To log in using SSH or Telnet:**

1. Ensure SSH or Telnet has been enabled.
2. Launch an SSH or Telnet client and open a console window. A login prompt appears.

```
login as: █
```

3. Type a name and press Enter. The name is case sensitive.

---

*Note: If using the SSH client, the name must NOT exceed 25 characters. Otherwise, the login fails.*

---

Then you are prompted to enter a password.

```
login as: admin
admin@192.168.84.88's password: █
```

4. Type a password and press Enter. The password is case sensitive.
5. After properly entering the password, the # or > system prompt appears.

---

*Tip: The "Last Login" information, including the date and time, is also displayed if the same user account was used to log in to this product's web interface or CLI.*

---

6. You are now logged in to the command line interface and can begin administering the Raritan device.

---

## SNMP Management

In the cascading chain, the SNMP capability of each Raritan device remains unchanged. A cascaded device is able to send SNMP notifications and communicate with an SNMP manager.

---

### SNMP Notifications

Like a standalone Raritan device, a cascaded Raritan device in the chain can also send out SNMP traps or informs to an SNMP destination. All you have to do is to configure the SNMP notification setting on that device. For details, see "Configuring SNMP Settings" in the online help, which is accessible from the application or on the Raritan website's **Support page** (<http://www.raritan.com/support/>).

---

### Third-Party SNMP Managers

A third-party SNMP manager can communicate with any Raritan device in the cascading chain. There are no differences made to the SNMP accessibility no matter the device is a master or slave device.

To allow a Raritan device to communicate with an SNMP manager, you must enable the SNMP agent implemented on that device and download the latest SNMP MIB for your SNMP manager. For details, see "Enabling and Configuring SNMP" in the online help, which is accessible from the application or on the Raritan website's **Support page** (<http://www.raritan.com/support/>).

---

## Port Numbers for Port-Forwarding Devices

All devices in a Port-Forwarding chain share the same IP address(es). Therefore, a port number is required when accessing any device in the chain.

---

### Port Number Syntax

In the Port Forwarding mode, all devices in the cascading chain share the same IP address(es). To access any cascaded device, you must assign an appropriate port number to it.

- Master device: The port number is either *5NNXX* or the standard TCP/UDP port.
- Slave device: The port number is *5NNXX*.

► **5NNXX port number syntax:**

- NN is a two-digit number representing the network protocol as shown below:

Protocols	NN
HTTPS	00
HTTP	01
SSH	02
TELNET	03
SNMP	05
MODBUS	06



- XX is a two-digit number representing the device position as shown below.

Position	XX	Position	XX
Master device	00	Slave 8	08
Slave 1	01	Slave 9	09
Slave 2	02	Slave 10	10
Slave 3	03	Slave 11	11
Slave 4	04	Slave 12	12
Slave 5	05	Slave 13	13
Slave 6	06	Slave 14	14
Slave 7	07	Slave 15	15

For example, to access the Slave 4 device via Modbus/TCP, the port number is 50604. See *Port Forwarding Examples* (on page 32) for further illustrations.

---

*Tip: The full list of each cascaded device's port numbers can be retrieved from the web interface. Choose Maintenance > Device Information > Port Forwarding.*

---

► **Standard TCP/UDP ports:**

The master device can be also accessed through standard TCP/UDP ports as listed in the following table.

Protocols	Port Numbers
HTTPS	443
HTTP	80
SSH	22
TELNET	23
SNMP	161
MODBUS	502

In the Port Forwarding mode, the Raritan device does NOT allow you to modify the standard TCP/UDP port configuration, including HTTP, HTTPS, SSH, Telnet and Modbus/TCP.

---

### Port Forwarding Examples

To access a cascaded device in the Port Forwarding mode, assign a port number to the IP address.

- Master device: Assign proper 5NNXX port numbers or standard TCP/UDP ports. See *Port Number Syntax* (on page 30) for details.
- Slave device: Assign proper 5NNXX port numbers.

**Assumption:** *The Port Forwarding mode is applied to a cascading chain comprising three Raritan devices. The IP address is 192.168.84.77.*

► **Master device:**

Position code for the master device is '00' so each port number is 5NN00 as listed below.

Protocols	Port numbers
HTTPS	50000
HTTP	50100
SSH	50200
TELNET	50300
SNMP	50500
MODBUS	50600

**Examples using "5NN00" ports:**

- To access the master device via HTTPS, the IP address is:  
*https://192.168.84.77:50000/*
- To access the master device via HTTP, the IP address is:  
*http://192.168.84.77:50100/*
- To access the master device via SSH, the command is:  
*ssh -p 50200 192.168.84.77*

**Examples using standard TCP/UDP ports:**

- To access the master device via HTTPS, the IP address is:  
*https://192.168.84.77:443/*
- To access the master device via HTTP, the IP address is:  
*http://192.168.84.77:80/*

- To access the master device via SSH, the command is:

```
ssh -p 22 192.168.84.77
```

► **Slave 1 device:**

Position code for Slave 1 is '01' so each port number is 5NN01 as shown below.

Protocols	Port numbers
HTTPS	50001
HTTP	50101
SSH	50201
TELNET	50301
SNMP	50501
MODBUS	50601

**Examples:**

- To access Slave 1 via HTTPS, the IP address is:

```
https://192.168.84.77:50001/
```

- To access Slave 1 via HTTP, the IP address is:

```
http://192.168.84.77:50101/
```

- To access Slave 1 via SSH, the command is:

```
ssh -p 50201 192.168.84.77
```

► **Slave 2 device:**

Position code for Slave 2 is '02' so each port number is 5NN02 as shown below.

Protocols	Port numbers
HTTPS	50002
HTTP	50102
SSH	50202
TELNET	50302
SNMP	50502
MODBUS	50602

**Examples:**

- To access Slave 2 via HTTPS, the IP address is:  
*https://192.168.84.77:50002/*
- To access Slave 2 via HTTP, the IP address is:  
*http://192.168.84.77:50102/*
- To access Slave 2 via SSH, the command is:  
*ssh -p 50202 192.168.84.77*

# Chapter 5 Identifying Cascaded Devices

You can retrieve a device's cascading status from one of these interfaces:

- Web interface: Accessible via HTTP or HTTPS.
- Command line interface (CLI): Accessible via SSH, Telnet or the serial interface.
- SNMP: An SNMP manager is required.
- LCD display: Use the front panel LCD display if your Raritan device has it.

Before remotely accessing a Raritan device, you need to get its IP address. See *Finding the IP Address* (on page 22).

## In This Chapter

Using the Web Interface .....	35
Using the CLI .....	38
Using the SNMP .....	40
Using the LCD Display.....	42

---

## Using the Web Interface

This section explains how to identify a cascaded device through the web interface.

The following only introduces the web interface of firmware version 3.3.10 or later, which is different from old firmware versions.

1. Log in to the desired Raritan device using a supported web browser. See *HTTP/HTTPS Access* (on page 27).
2. Choose Maintenance > Device Information.
3. Click the Network title bar.



- If the information shown on this page does not match the latest status, press F5 to reload it.

► **Cascading information in the Bridging mode:**

- The Common section contains two read-only fields for indicating the cascading status. Note that the cascading position is NOT available in the Bridging mode.

Fields	Description
Port Forwarding	Indicates the Port Forwarding is disabled. See <i>Setting the Cascading Mode</i> (on page 8).
BRIDGE section	Indicates the device is in the Bridging mode and its IP address.

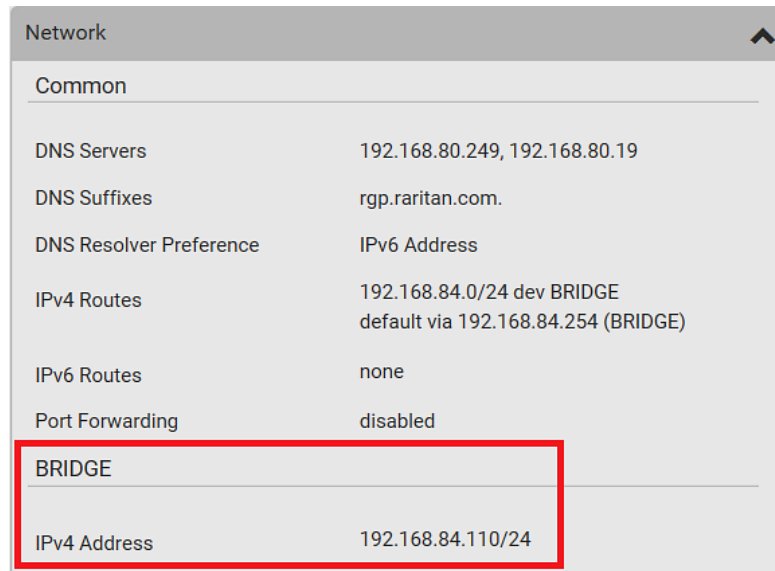

► **Cascading information in the Port Forwarding mode:**

- The Common section contains three read-only fields for indicating the cascading status.

Fields	Description
Port Forwarding	Indicates the Port Forwarding is enabled. See <i>Setting the Cascading Mode</i> (on page 8).
Cascade Position	Indicates the position of the Raritan device in the cascading chain. <ul style="list-style-type: none"> <li>▪ 0 (zero) represents the master device.</li> <li>▪ A non-zero number represents a slave device. 1 is Slave 1, 2 is Slave 2, 3 is Slave 3 and so on.</li> </ul>

Fields	Description
Cascaded Device Connected	Indicates whether a slave device is detected on the USB-A or Ethernet port. <ul style="list-style-type: none"> <li>yes: Connection to a slave device is detected.</li> <li>no: NO connection to a slave device is detected.</li> </ul>

- A master device shows 0(zero) in the Cascade Position field and *yes* in the Cascaded Device Connected field.

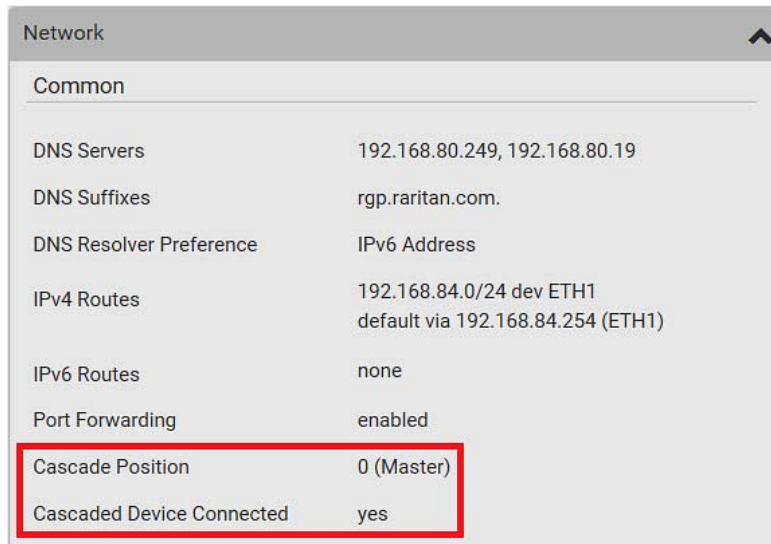

- A slave device in the middle position shows a non-zero number which indicates its exact position in the Cascade Position field and *yes* in the Cascaded Device Connected field.

The following diagram shows 1, indicating it is the first slave - Slave 1.



- The final slave device shows a non-zero number which indicates its position in the Cascade Position field and *no* in the Cascaded Device Connected field.

The following diagram shows 2, indicating it is the second slave - Slave 2. The Cascaded Device Connected field shows *no*, indicating that it is the final one in the chain.



The screenshot shows a 'Network' configuration window with a 'Common' section. The 'Cascade Position' field is highlighted with a red box and contains the value '2 (Slave)'. The 'Cascaded Device Connected' field contains the value 'no'.

Common	
DNS Servers	192.168.80.249, 192.168.80.19
DNS Suffixes	rgp.raritan.com.
DNS Resolver Preference	IPv6 Address
Port Forwarding	enabled
Cascade Position	2 (Slave)
Cascaded Device Connected	no

- For a list of port numbers required for accessing each cascaded device in the Port Forwarding mode, click the Port Forwarding title bar on the same page.



---

## Using the CLI

This section explains how to identify a cascaded device through CLI.

The following only introduces the CLI commands of firmware version 3.3.10 or later, which are different from pre-3.3.10 firmware versions.

1. Log in to the CLI of the desired cascaded device. To use the SSH or Telnet service, see ***SSH/Telnet Access*** (on page 28).
2. Type the following CLI commands and press Enter.

```
# show network
```



► **In the Bridging mode:**

In the Bridging mode, IP-related information is shown under the 'BRIDGE' interface, similar to the following.

```
Interface 'BRIDGE'
Link
  MAC address:      00:0d:5d:0e:e1:2d
IPv4
  Config method:   DHCP
  Address:         None
  Preferred hostname: Not configured
  DHCP server:     Not available
IPv6
  Disabled
```

► **In the Port Forwarding mode:**

In the Port Forwarding mode, the Port Forwarding status shows 'Enabled'.

```
Port forwarding
Status:      Enabled
```

The 'Role' or 'Slave number' field indicates the device's position.

- For a master device, the Role field shows 'Master'.

```
Port forwarding
Status:      Enabled
Role:       Master
```

- For a slave device, the Role field shows 'Slave'. The 'Slave number' field indicates its position: 1 is the first slave device, 2 is the second, and so on.

```
Port forwarding
Status:      Enabled
Role:       Slave
Slave number: 1
```

## Using the SNMP

The *unitConfigurationTable* in MIB contains entries for cascading information. One SNMP MIB manager, such as a MIB browser, is required for retrieving the SNMP data.

As of release 3.3.10, cascading information other than the cascading mode is no longer available in the Bridging mode, but all cascading information remains available in the Port Forwarding mode.

### ► In the Port Forwarding mode:

1. Launch your SNMP MIB manager and connect to the desired Raritan device.
2. To find whether the Raritan device is in a cascading chain, retrieve the value of either one below:
  - SNMP name - **pduDaisychainMemberType**
  - SNMP object identifier (OID) - **1.3.6.1.4.1.13742.6.3.2.2.1.41**

One of the following values is returned.

SNMP value	Description
standalone (0)	The Raritan device is not in the cascading chain. It is a standalone device.
master (1)	The Raritan device is the master device.
slave (2)	The Raritan device is a slave device.

3. To check which cascading mode is applied, retrieve the value of either one below:
  - SNMP name - **deviceCascadeType**
  - SNMP OID - **1.3.6.1.4.1.13742.6.3.2.2.1.70**

One of the values in the following table is returned.

SNMP value	Cascading mode
0	Bridging mode
1	Port Forwarding mode

The value 1 is returned in the Port Forwarding mode.

4. To identify the device's position in the cascading chain, retrieve the value of either one below:
  - SNMP name - **deviceCascadePosition**
  - SNMP OID - **1.3.6.1.4.1.13742.6.3.2.2.1.71**

One of the following values is returned.

SNMP value	Device position
0	Master device
1 to 15	Slave 1 to Slave 15

- To find whether the Raritan device is the final slave device, retrieve the value of either one below:

- SNMP name - **cascadedDeviceConnected**
- SNMP OID - **1.3.6.1.4.1.13742.6.3.2.2.1.58**

Check which value is returned. A final slave device has NO slave device connected to its Ethernet (ETH1 or ETH2) or USB-A port.

SNMP value	Description
true (1)	A slave device has been connected to either Ethernet or USB-A port of this Raritan device.
false (2)	No slave device is connected to either Ethernet or USB-A port of this Raritan device.

► **In the Bridging mode:**

- Launch your SNMP MIB manager and connect to the desired Raritan device.
- To check which cascading mode is applied, retrieve the value of either one below:

- SNMP name - **deviceCascadeType**
- SNMP OID - **1.3.6.1.4.1.13742.6.3.2.2.1.70**

One of the values in the following table is returned.

SNMP value	Cascading mode
0	Bridging mode
1	Port Forwarding mode

The value 0 is returned in the Bridging mode.

- The following cascading information is NOT available in the Bridging mode so they always show a permanent value, which CANNOT correctly indicate the current cascading status.
  - `pduDaisychainMemberType`  
(1.3.6.1.4.1.13742.6.3.2.2.1.41) always shows 'standalone (0)'
  - `deviceCascadePosition`  
(1.3.6.1.4.1.13742.6.3.2.2.1.71) always shows 'Master device (0)'

- `cascadedDeviceConnected`  
(1.3.6.1.4.1.13742.6.3.2.2.1.58) always shows 'false  
(2)'

---

## Using the LCD Display

Some Raritan products have a front panel LCD display which can show cascading information, such as the device position.

Depending on the Raritan product you purchased, the LCD display type varies.



- PX3, PX3-iX7, PX3TS-iX7, BCM2, PMC, and PMMC models have a dot-matrix LCD display.
- EMX, PX3TS, and BCM1 have a character LCD display.

---





### Dot-Matrix LCD Display

On the dot-matrix LCD display, available cascading information depends on the cascading mode.

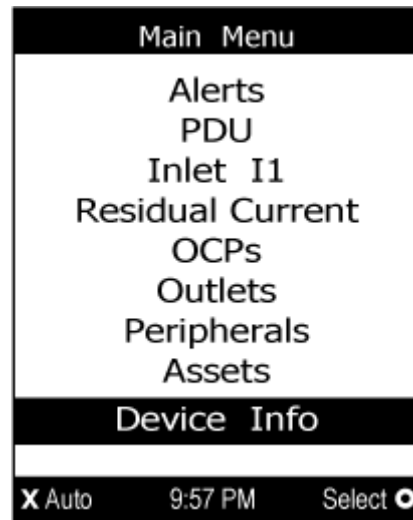
Note that the diagrams illustrated in this section are for Zero U PDUs, and your dot-matrix LCD display may look slightly different if it is on a different product model.

1. If the LCD display is in the Automatic mode, exit it by pressing  or . The Main Menu similar to the following is displayed.



2. Press  or  to select "Device Info" in the Main Menu, and press .
3. Press  until the Network Cascading page displays.

► **Bridging mode:**

In this mode, the LCD display only indicates the Bridging mode is enabled, but the device position information is NOT available.

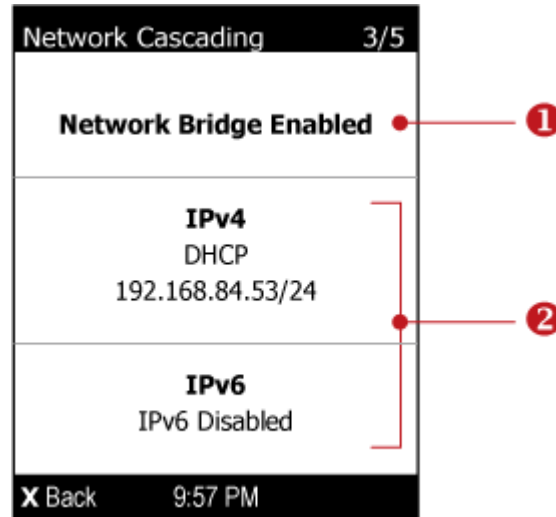

Number	Description
①	Current cascading mode. <ul style="list-style-type: none"> <li>In the above diagram, it shows the Bridging mode.</li> </ul>
②	IPv4/IPv6 network information, including: <ul style="list-style-type: none"> <li>Network configuration: DHCP (or Automatic), or Static. Static represents Static IP.</li> <li>The device's IP address.</li> <li>IPv4 or IPv6 prefix length (such as "/24").</li> </ul>

If you do not enable IPv4 or IPv6 settings, a message is displayed to indicate IPv4 or IPv6 is disabled.

► **Port Forwarding mode:**

In this mode, the LCD display indicates the cascading mode, device position and the presence/absence of a connected slave device.

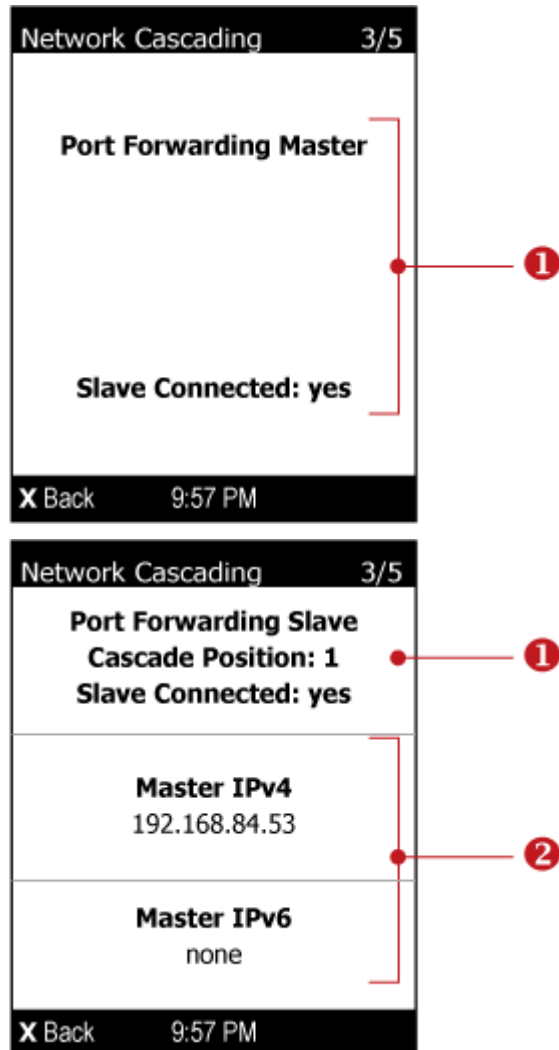

Number	Description
①	Cascading mode-related information, including: <ul style="list-style-type: none"> <li>▪ Port Forwarding mode</li> <li>▪ Master or Slave</li> <li>▪ Cascade position -- This information is available on slave devices only. 1 represents the first slave, 2 represents the second slave, and the like.</li> <li>▪ Slave Connected: <i>yes</i> indicates a downstream slave device is detected, and <i>no</i> indicates no downstream slave devices are detected.</li> </ul>
②	The master device's IPv4/IPv6 address.

### Character LCD Display

Note: As of release 3.3.10, the following cascading information is no longer available in the Bridging mode, but remains available in the Port Forwarding mode.

A cascaded device's position is available by operating the LCD display. Below illustrates a slave device's position.

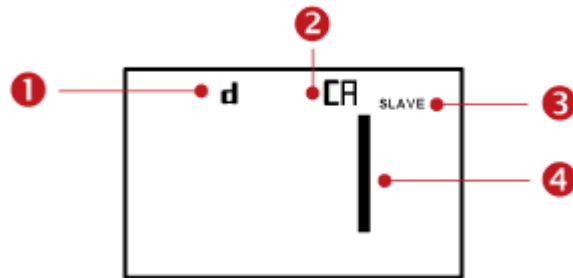

Section	Example information
①	"d" means the LCD display has entered the Device mode.
②	"CA" indicates that the cascading information is being displayed.

Section	Example information
<b>3</b>	"SLAVE" indicates that this Raritan device is a slave device. <hr/> <i>Note: For a master device, it shows the word "MASTER" instead.</i> <hr/>
<b>4</b>	The number 1 means the device position is Slave 1.

► **To retrieve the device's cascading position information:**

1. Press the MODE button to enter the Device mode, indicated by a 'd' in at the top left of the display.
2. Press the FUNC button until "CA" is displayed at the top right of the display.
3. The device's position is represented by any number defined below:

Number	Device position	Number	Device position
<b>0</b>	Master device	<b>8</b>	Slave 8
<b>1</b>	Slave 1	<b>9</b>	Slave 9
<b>2</b>	Slave 2	<b>10</b>	Slave 10
<b>3</b>	Slave 3	<b>11</b>	Slave 11
<b>4</b>	Slave 4	<b>12</b>	Slave 12
<b>5</b>	Slave 5	<b>13</b>	Slave 13
<b>6</b>	Slave 6	<b>14</b>	Slave 14
<b>7</b>	Slave 7	<b>15</b>	Slave 15



## Chapter 6 Adding, Removing or Swapping Cascaded Devices

Change a device's cascading mode first before adding that device to a cascading chain, or before disconnecting that device from the chain.

If you only want to change the cascading mode of an existing chain, or swap the master and slave device, always start from the slave device.

---

*Note: If the following procedures are not followed, a networking issue occurs. When a networking issue occurs, check the cascading connection and/or software settings of all devices in the chain. See **Cascading Troubleshooting** (on page 55).*

---

### ▶ To add a device to an existing chain:

1. Connect the Raritan device to the LAN and find its IP address, or connect it to a computer.
2. Log in to this device and set its cascading mode to be the same as the existing chain's cascading mode. See **Setting the Cascading Mode** (on page 8).
3. Connect it to the chain, using either a USB or Ethernet cable.

### ▶ To remove a device from the chain:

1. Log in to the desired cascaded device, and change its cascading mode to None.

---

*Exception: If you are going to connect the removed device to another cascading chain, set its cascading mode to be the same as the mode of another chain.*

---

2. Now disconnect it from the cascading chain.

### ▶ To swap the master and slave device:

- In the Bridging mode, you can swap the master and slave devices by simply disconnecting ALL cascading cables from them, and then reconnecting cascading cables. No changes to software settings are required.
- In the Port Forwarding mode, you must follow the procedure below:
  - a. Access the slave device that will replace the master device, and set its role to 'Master', and correctly set the downstream interface.
  - b. Access the master device, set its role to 'Slave'.
  - c. Swap the master and slave device now. You must disconnect ALL cascading cables connected to the two devices first before swapping them and reconnecting cascading cables.

► **To change the cascading mode applied to a chain:**

1. Access the last slave device, and change its cascading mode.
  - If the new cascading mode is 'Port Forwarding', you must also set its role to 'Slave'.
2. Access the second to last, third to last and so on until the first slave device to change their cascading modes one by one.
3. Access the master device, and change its cascading mode.
  - If the new cascading mode is 'Port Forwarding', you must also set its role to 'Master', and correctly select the downstream interface.

The following diagram indicates the correct sequence. 'N' is the final one.

- M = Master device
- S = Slave device



## Chapter 7 Firmware Upgrade

You can upgrade each individual Raritan device in the cascading chain through the web interface. The upgrade procedure is completely identical to the procedure for a standalone Raritan device.

Firmware version 3.3.10 or later is NOT compatible with pre-3.3.10 firmware versions in terms of the cascading feature so all devices in the cascading chain must run version 3.3.10 or later.

To upgrade an existing USB-cascading chain from a firmware version older than 3.3.10, you must start from the last slave device and so on until the master device. Otherwise, a networking issue occurs. See *Upgrade Sequence in an Existing Cascading Chain* (on page 50).

### In This Chapter

Updating the Raritan device Firmware .....	49
Upgrade Sequence in an Existing Cascading Chain .....	50

---

### Updating the Raritan device Firmware

Firmware files are available on Raritan website's *Support page* (<http://www.raritan.com/support/>).

► **To update the firmware:**

1. Choose Maintenance > Update Firmware.
2. Click  to select an appropriate firmware file.
3. Click Upload. A progress bar appears to indicate the upload process.
4. Once complete, information of both installed and uploaded firmware versions as well as compatibility and signature-checking results are displayed.
  - If anything is incorrect, click Discard Upload.
5. To proceed with the update, click Update Firmware.

---

*Warning: Do NOT power off the Raritan device during the update.*

---

6. When the update is complete, the Raritan device resets, and the Login page re-appears.

---

**Important:** If you are using the Raritan device with an SNMP manager, download its MIB again after the firmware update to ensure your SNMP manager has the correct MIB for the latest release you are using.

---

---

## Upgrade Sequence in an Existing Cascading Chain

Depending on the firmware version(s) of your cascading chain, there may or may not be limitations for the firmware upgrade sequence in the chain.

► **Upgrade from "pre-3.3.10" to 3.3.10 or post-3.3.10:**

You must follow the firmware upgrade sequence below to upgrade a cascading chain from a firmware version older than 3.3.10 to version 3.3.10 or later. If you do not follow this upgrade sequence, you will not be able to access some cascaded devices over the Internet.

- The upgrade must start from the last slave device (S), then the second to last, the third to last, and so on until the master device (M).

Red numbers below represent the appropriate upgrade sequence. 'N' is the final one to upgrade.



- You must upgrade ALL devices in the chain to 3.3.10 or later. If you upgrade only some devices in the chain, networking issues occur on some cascaded devices.

► **Upgrade from 3.3.10 or post-3.3.10 to post-3.3.10:**

There is no upgrade sequence limitation.

Firmware version 3.3.10 is compatible with later firmware versions so you can upgrade all devices of the chain in a random order.

---

**Important: Raritan does not guarantee that no upgrade sequence limitation will be required for all future firmware versions. It is highly suggested to check the latest revision of the Cascading Guide or your product's User Guide/Online Help before performing the firmware upgrade. The other alternative is to always stick to the same sequence as the above diagram.**

---

► **Downgrade from 3.3.10 to pre-3.3.10:**

There is no downgrade sequence limitation.

Firmware versions earlier than 3.3.10 are compatible with each other so you can downgrade or upgrade all devices of the chain in a random order when .

---

*Note: Firmware downgrade in a cascading chain is NOT recommended. Consult Raritan Technical Support first if downgrade is needed. It is suggested to always stick to the same sequence as the above diagram.*

---

# Appendix A Unsupported Cascading Connections for Port Forwarding

The following guidelines must be obeyed for establishing a cascading chain in the **Port Forwarding** mode.

- Each cascaded device, except for the master device, must have only one upstream device.
- Each cascaded device, except for the last slave device, must have only one downstream device.
- Use only one cable to cascade two devices. That is, NO simultaneous connection of USB and Ethernet cables between two cascaded devices.

The following diagrams illustrate cascading connections that are NOT supported.

---

*Note: These diagrams are based on Raritan's PX3-iX7 Zero U PDUs, but the same guidelines apply to other Raritan iX7™ products.*

---

▶ **UNSUPPORTED connections:**

- One cascaded device has two upstream devices via Ethernet cables.

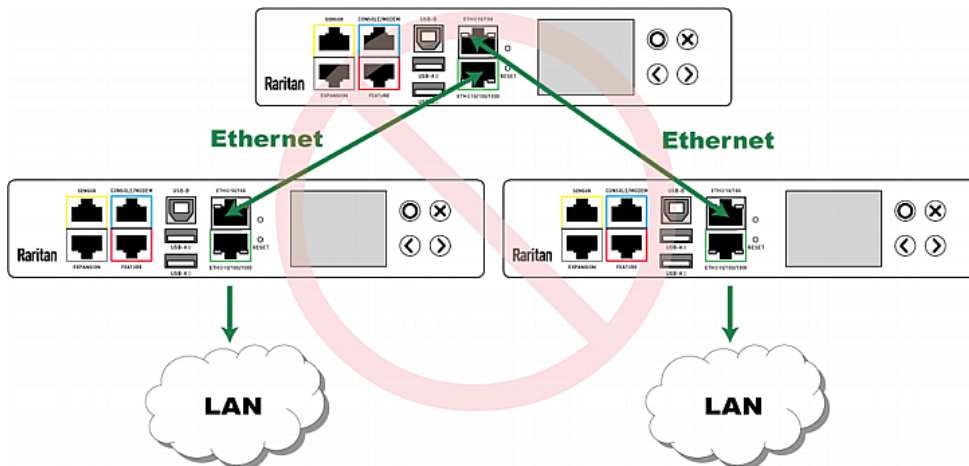

- One cascaded device has two upstream devices via Ethernet and USB cables.

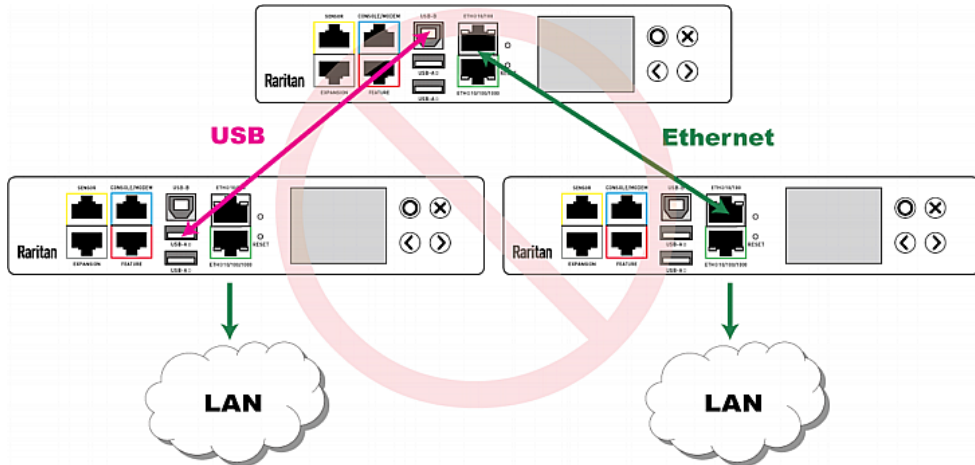

- One cascaded device has two downstream devices.

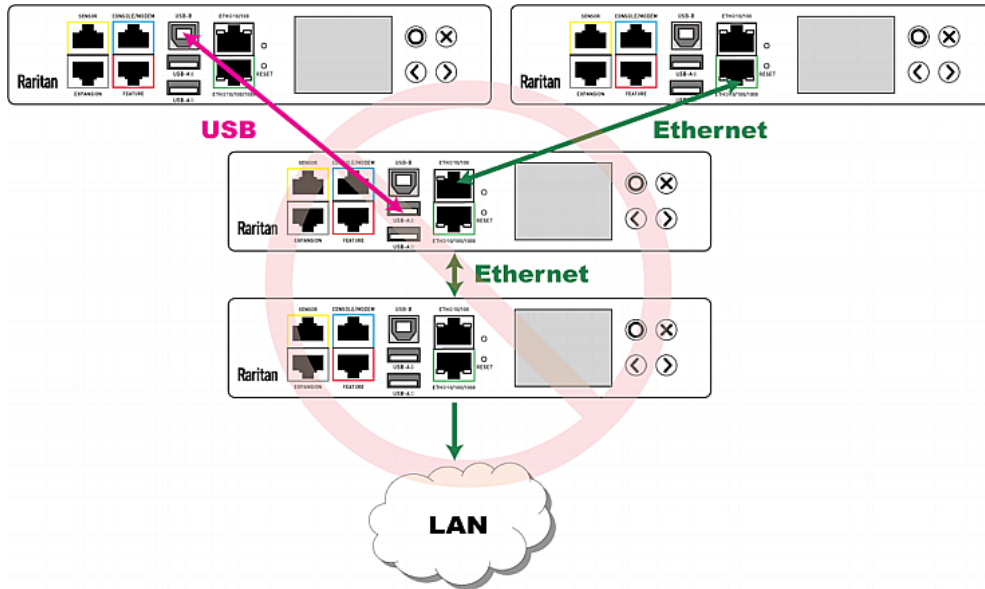

Appendix A: Unsupported Cascading Connections for Port Forwarding

- One device is connected to another device via two cascading cables - USB and Ethernet cables.

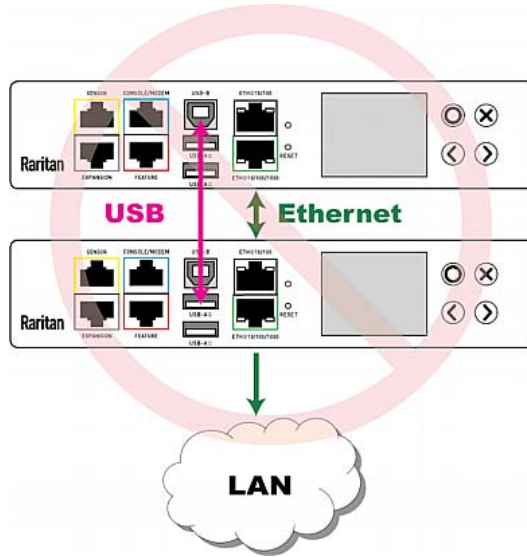



## Appendix B Cascading Troubleshooting

Any accessibility problem occurred on one of the devices in the cascading chain may result in failure to access all downstream slave devices that are connected to it.

### In This Chapter

Possible Root Causes.....	55
Slave Device Events in the Log.....	58
The Ping Tool.....	58

---

### Possible Root Causes

The following lists the network accessibility issues and possible root causes.

You can always troubleshoot the software settings by connecting the Raritan device to a computer if network access to that Raritan device fails. See *Connecting the Raritan device to a Computer* (on page 62).

Symptom	Probable cause
<p>Failure to access the master device</p>	<ul style="list-style-type: none"> <li>• Anything below is lost on the master device:                             <ul style="list-style-type: none"> <li>▪ Network connection</li> <li>▪ Power supply</li> </ul> </li> <li>• Anything below is disabled on the master device:                             <ul style="list-style-type: none"> <li>▪ The Ethernet or wireless interface</li> <li>▪ IPv4 or IPv6 settings</li> </ul> </li> <li>• In the Port Forwarding mode, related settings are incorrectly configured on the master device.                             <ul style="list-style-type: none"> <li>▪ The master device's role is incorrectly set to 'Slave'.</li> <li>▪ The interface where the network is connected is incorrectly set as the downstream interface.</li> </ul> </li> <li>• For the wireless networking, one of the following issues occurs:                             <ul style="list-style-type: none"> <li>▪ The USB wireless LAN adapter attached to the master device is not the Raritan USB WIFI LAN adapter. See <i>USB Wireless LAN Adapters</i> (on page 71).</li> <li>▪ The wireless LAN configuration is not supported. See <i>Supported Wireless LAN Configuration</i> (on page 71).</li> <li>▪ The installed CA certificate chain contains any certificate that has expired or is not valid yet.</li> </ul> </li> </ul>

Symptom	Probable cause
Failure to access a slave device	<ul style="list-style-type: none"> <li>• One of the following issues occurs on the master device: <ul style="list-style-type: none"> <li>▪ Network connection is lost.</li> <li>▪ The Ethernet or wireless interface is disabled.</li> </ul> </li> <li>• One of the following issues occurs on the slave device in question or any upstream device (if available): <ul style="list-style-type: none"> <li>▪ Connection of the cascading cable is loose or lost.</li> <li>▪ No power supply.</li> <li>▪ The cascading mode is set incorrectly. For example, the master device is set to Bridging, but the slave device in question or any upstream device is set to Port Forwarding.</li> </ul> </li> <li>• In the Bridging mode, IPv4 (or IPv6) settings are disabled on the slave device in question.</li> <li>• In the Port Forwarding mode, one of the following issues occurs: <ul style="list-style-type: none"> <li>▪ The master device's role is incorrectly set to 'Slave'.</li> <li>▪ The master device's downstream interface is incorrectly set. For example, you use a USB cable to connect the 1st slave device, but select the Ethernet port as the downstream interface.</li> <li>▪ The role of the slave device in question or any upstream device is set to 'Master' instead of 'Slave'.</li> <li>▪ The port number you added to the IP address is incorrect. See <i>Port Number Syntax</i> (on page 30).</li> <li>▪ IPv4 (or IPv6) settings are disabled on the master device.</li> </ul> </li> <li>• The slave device in question or any upstream device runs a "pre-3.3.10" firmware version while the rest of the chain runs firmware version 3.3.10 or later.</li> </ul>

---

*Tip: To determine which Raritan device may be the failure point of network, you may ping each Raritan device in the cascading chain, or check the slave-related events in the event log of each Raritan device. See **The Ping Tool** (on page 58) and **Slave Device Events in the Log** (on page 58).*

---

► **For an iX7™ cascading chain, also check the following:**

- Whether the Ethernet interface (ETH1 or ETH2) where the network or cascading cable is connected is disabled on the cascaded device in question or any upstream device.
- Whether the connection complies with the cascading guidelines if it is set to the Port Forwarding mode. See **Unsupported Cascading Connections for Port Forwarding** (on page 52).

---

## Slave Device Events in the Log

In the Bridging mode, events regarding connection/disconnection of a downstream slave device via USB is NOT logged.

However, in the Port Forwarding mode, whenever the connection or disconnection of a downstream slave device via USB is detected, the Raritan device at the USB-A end of the USB cable logs it in the internal log. Note that the Raritan device at the USB-B end of the cable does NOT log these events.

There are two slave-related events in the Port Forwarding mode:

Event	Description
Slave connected	This log entry is generated when a Raritan device detects the presence of a slave device on its USB-A port.
Slave disconnected	This log entry is generated when it detects the disconnection of a slave device from its USB-A port.

---

## The Ping Tool

The Raritan device provides a ping tool in the web interface and CLI so you can ping any host or Raritan device in your data center.

---

### Ping via the Web Interface

To log in to the web interface, see *Login* (on page 27).

The Ping tool is useful for checking whether a host is accessible through the network or Internet.

► **To ping a host:**

1. Choose Maintenance > Network Diagnostics.
2. Type values in the following fields.

Field	Description
Network Host	The name or IP address of the host that you want to check.
Number of Requests	A number up to 20. This determines how many packets are sent for pinging the host.

3. Click Run Ping to ping the host. The Ping results are then displayed.

---

### Ping via the CLI

You can access the CLI interface by connecting a computer to the Raritan device or using SSH/Telnet. See *SSH/Telnet Access* (on page 28) for details.

You must perform the ping command in the diagnostic mode. To enter the diagnostic mode, type the following command and press Enter.

```
#          diag
```

After the diag> or diag# prompt appears, you can perform the ping command.

This ping command sends the ICMP ECHO\_REQUEST message to a network host for checking its network connectivity. If the output shows the host is responding properly, the network connectivity is good. If not, either the host is shut down or it is not being properly connected to the network.

```
diag>      ping <host>
```

#### Variables:

- <host> is the host name or IP address whose networking connectivity you want to check.

#### Options:

- You can include any or all of additional options listed below in the ping command.

Options	Description
count <number1>	Determines the number of messages to be sent. <number1> is an integer number between 1 and 100.
size <number2>	Determines the packet size. <number2> is an integer number in bytes between 1 and 65468.
timeout <number3>	Determines the waiting period before timeout. <number3> is an integer number in seconds ranging from 1 to 600.

The command looks like the following when it includes all options:

```
diag> ping <host> count <number1> size <number2> timeout <number3>
```

# Appendix C Additional Information

## In This Chapter

Connecting the Raritan device to a Computer .....	62
Configuring Network Settings.....	64
Wireless LAN Information.....	71

---

## Connecting the Raritan device to a Computer

To change the cascading mode of any Raritan device, you can connect it to the computer via one of the following ports on the Raritan device.

- ETHERNET port
- USB-B port
- RS-232 serial port (model dependent -- RJ-45 or male DB9 connector)

To use the command line interface (CLI) for configuration, establish an RS-232 or USB connection.

To use a web browser for configuration, make a network connection to the computer. The Raritan device is automatically configured with the following link-local addressing in any network without DHCP available:

- *https://169.254.x.x* (where x is a number)
- *https://pdu.local*

---

## Making a Connection

Establish one of the following connections to a computer. The Ethernet port of Raritan device must be enabled for the described connection to work properly. Per default, the Ethernet port is enabled.

### ▶ Direct network connection:

1. Connect one end of a standard network patch cable to the ETHERNET port of the Raritan device.
  - For iX7™ with dual Ethernet ports, either Ethernet port is fine.
2. Connect the other end to a computer's Ethernet port.
3. On the connected computer, launch a web browser to access the Raritan device, using either link-local addressing: *pdu.local* or *169.254.x.x*.

### ▶ Serial connection for "DB9" RS-232 connector on Raritan device:

1. Connect one end of the null-modem DB9 cable to the male "DB9" RS-232 port labeled CONSOLE / MODEM on the Raritan device.



2. Connect the other end to your computer's RS-232 port (COM).
- ▶ **Serial connection for "RJ-45" RS-232 connector on iX7™ devices:**
    - The iX7™ device's serial connection procedure is the same as above except that a third party RJ-45 to "DB9 female" adapter/cable is required, such as the blue Cisco adapter cable. This is because the CONSOLE / MODEM port on the iX7™ device is a female RJ-45 connector.
  - ▶ **USB connection:**
    1. A USB-to-serial driver is required in Windows®. Install this driver before connecting the USB cable. See *Installing the USB-to-Serial Driver (Optional)* (on page 63).
    2. Connect a USB cable between the Raritan device's USB-B port and a computer's USB-A port.

---

### Installing the USB-to-Serial Driver (Optional)

The Raritan device can emulate a USB-to-serial converter over a USB connection. A USB-to-serial driver named "Dominion PX2 (or EMX)Serial Console" is required for Microsoft® Windows® operating systems.

Download the Windows driver for USB serial console from the Raritan website's *Support page* (<http://www.raritan.com/support/>). The downloaded driver's name is *dominion-serial-setup-<n>.exe*, where <n> represents the file's version number.

There are two ways to install this driver: automatic and manual installation. Automatic driver installation is highly recommended.

- ▶ **Automatic driver installation in Windows®:**
  1. Make sure the Raritan device is NOT connected to the computer via a USB cable.
  2. Run *dominion-serial-setup-<n>.exe* on the computer and follow online instructions to install the driver.

---

*Note: If any Windows security warning appears, accept it to continue the installation.*

---

3. Connect the Raritan device to the computer via a USB cable. The driver is automatically installed.
- ▶ **Manual driver installation in Windows®:**
    1. Make sure the Raritan device has been connected to the computer via a USB cable.
    2. The computer detects the new device and the "Found New Hardware Wizard" dialog appears.

- If this dialog does not appear, choose Control Panel > System > Hardware > Device Manager, right-click the *Dominion PX2 (or EMX)Serial Console*, and choose Update Driver.
3. Select the option of driver installation from a specific location, and then specify the location where both *dominion-serial.inf* and *dominion-serial.cat* are stored.

---

*Note: If any Windows security warning appears, accept it to continue the installation.*

---

4. Wait until the installation is complete.

---

*Note: If the Raritan device enters the disaster recovery mode when the USB serial driver is not installed yet, it may be shown as a 'GPS camera' in the Device Manager on the computer connected to it.*

---

► **In Linux:**

No additional drivers are required, but you must provide the name of the tty device, which can be found in the output of the "dmesg" after connecting the Raritan device to the computer. Usually the tty device is "/dev/ttyACM#" or "/dev/ttyUSB#," where # is an integer number.

For example, if you are using the kermit terminal program, and the tty device is "/dev/ttyACM0," perform the following commands:

```
> set line /dev/ttyACM0
> Connect
```

---

## Configuring Network Settings

Network settings can be configured through either the web interface or command line interface (CLI). This appendix only shows basic operation. For details, see the online help or User Guide for your Raritan device.

- In the Bridging mode, each cascaded device can have different network settings. You may need to configure each device's network settings in the BRIDGE section.
- In the Port Forwarding mode, all cascaded devices share the master device's network settings. You only need to configure the master device's network settings in the ETHERNET (or ETH1/ETH2) and/or WIRELESS section.

## Configuration via Web Interface

When you are able to connect to the master or slave device over Internet, you can access its web interface to change the network settings.

Note that all slave devices share the master device's IP address(es) in the Port-Forwarding mode. To access a Port-Forwarding slave device, you must add a port number to the end of the IP address. See ***Port Numbers for Port-Forwarding Devices*** (on page 30).

### ► To change initial network settings:

1. Launch a web browser and type the IP address of the Raritan device in the address bar.

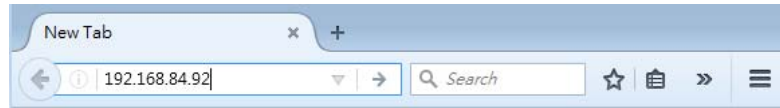

2. Accept any warnings that may appear and log in to that Raritan device using the administrator account.
  - User name: *admin*
  - Password: *raritan* (or a new password if you have changed the default)

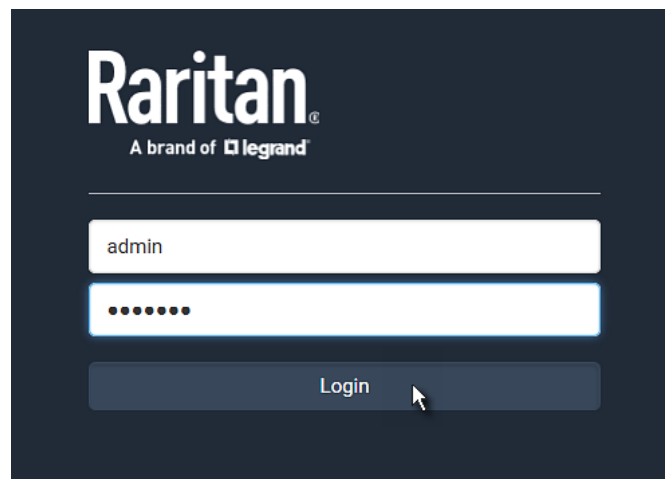

3. If this is the first time to log in to the Raritan device, you are prompted to change the password. Type the new password.
4. Choose Device Settings > Network.
5. (Optional) If the current cascading mode does not meet your needs, select an appropriate cascading mode: Bridging or Port Forwarding.
  - For the Port Forwarding mode, you must also set the role and downstream interface correctly.
6. Go to the correct interface to enable IPv4, IPv6 or both protocols.

- In the Bridging mode, click the BRIDGE interface.
  - In the Port Forwarding mode, click ETHERNET (or ETH1/ETH2) and/or WIRELESS interface on the master device.
7. Depending on which IP protocol has been enabled in the above step, configure the corresponding IP settings.

---

### Configuration via CLI

If you want to configure a master or slave device's network settings via CLI, you must connect that device to a computer via a serial RS-232 connection.

You can also access the master device's CLI through a USB connection. For details, see the Quick Setup Guide, Online Help or User Guide, which can be downloaded from Raritan website's *Support page* (<http://www.raritan.com/support/>).

► **To configure network settings via CLI:**

1. On the computer connected to the Raritan device, open a communications program such as HyperTerminal or PuTTY.
2. Select the appropriate COM port, and set the following port settings:
  - Bits per second = 115200 (115.2Kbps)
  - Data bits = 8
  - Stop bits = 1
  - Parity = None
  - Flow control = None

---

*Tip: For a USB connection, you can determine the COM port by choosing Control Panel > System > Hardware > Device Manager, and locating the "Dominion PX2 (or EMX)Serial Console" under the Ports group.*

---

3. In the communications program, press Enter to send a carriage return to the Raritan device.
4. The Raritan device prompts you to log in. Both user name and password are case sensitive.
  - a. Username: admin
  - b. Password: raritan (or a new password if you have changed it).
5. If prompted to change the default password, change or ignore it.
  - To change it, follow onscreen instructions to type your new password.
  - To ignore it, simply press Enter.
6. The # prompt appears.
7. Type `config` and press Enter.

8. To configure network settings, type appropriate commands and press Enter. Refer to the following commands list. CLI commands are case sensitive.
9. After finishing the network settings, type `apply` to save changes. To abort, type `cancel`.

► **Commands for wired networking:**

---

*The <ipvX> variable in the following commands is either ipv4 or ipv6, depending on the type of IP protocol you are configuring.*

---

**For all Raritan products other than PX3-iX7, replace the variable <ETH> with the word "ethernet". For PX3-iX7, replace the variable <ETH> with either 'ETH1' or 'ETH2', depending on which Ethernet port you are configuring.**

- **General IP settings:**

To set or enable	Use this command
IPv4 or IPv6 protocol	network <ipvX> interface <ETH> enabled <option>  <option> = <i>true</i> , or <i>false</i>
IPv4 configuration method	network ipv4 interface <ETH> configMethod <mode>  <mode> = <i>dhcp</i> (default) or <i>static</i>
IPv6 configuration method	network ipv6 interface <ETH> configMethod <mode>  <mode> = <i>automatic</i> (default) or <i>static</i>
Preferred host name (optional)	network <ipvX> interface <ETH> preferredHostName <name>  <name> = preferred host name
IP address returned by the DNS server	network dns resolverPreference <resolver>  <resolver> = <i>preferV4</i> or <i>preferV6</i>

- **Static IP configuration:**

To set	Use this command
Static IPv4 or IPv6 address	<pre>network &lt;ipvX&gt; interface &lt;ETH&gt; address &lt;ip address&gt;</pre> <p>&lt;ip address&gt; = static IP address, with a syntax similar to the example below.</p> <ul style="list-style-type: none"> <li>▪ Example: <i>192.168.7.9/24</i></li> </ul>
Static IPv4 or IPv6 gateway	<pre>network &lt;ipvX&gt; gateway &lt;ip address&gt;</pre> <p>&lt;ip address&gt; = gateway's IP address</p>
IPv4 or IPv6 primary DNS server	<pre>network dns firstServer &lt;ip address&gt;</pre> <p>&lt;ip address&gt; = DNS server's IP address</p>
IPv4 or IPv6 secondary DNS server	<pre>network dns secondServer &lt;ip address&gt;</pre> <p>&lt;ip address&gt; = DNS server's IP address</p>
IPv4 or IPv6 third DNS server	<pre>network dns thirdServer &lt;ip address&gt;</pre> <p>&lt;ip address&gt; = DNS server's IP address</p>

- ▶ **Commands for wireless networking:**

- **General wireless settings:**

To set or enable	Use this command
Wireless interface	<pre>network wireless enabled &lt;option&gt;</pre> <p>&lt;option&gt; = <i>true</i>, or <i>false</i></p>
SSID	<pre>network wireless SSID &lt;ssid&gt;</pre> <p>&lt;ssid&gt; = SSID string</p>
BSSID	<pre>network wireless BSSID &lt;bssid&gt;</pre> <p>&lt;bssid&gt; = AP MAC address or <i>none</i></p>

To set or enable	Use this command
802.11n protocol	<pre>network wireless enableHT &lt;option&gt;</pre> <p>&lt;option&gt; = <i>true</i>, or <i>false</i></p>
Authentication method	<pre>network wireless authMethod &lt;method&gt;</pre> <p>&lt;method&gt; = <i>psk</i> or <i>eap</i></p>
PSK	<pre>network wireless PSK &lt;psk&gt;</pre> <p>&lt;psk&gt; = PSK string</p>
EAP outer authentication	<pre>network wireless eapOuterAuthentication &lt;outer_auth&gt;</pre> <p>&lt;outer_auth&gt; = <i>PEAP</i></p>
EAP inner authentication	<pre>network wireless eapInnerAuthentication &lt;inner_auth&gt;</pre> <p>&lt;inner_auth&gt; = <i>MSCHAPv2</i></p>
EAP identity	<pre>network wireless eapIdentity &lt;identity&gt;</pre> <p>&lt;identity&gt; = your user name for EAP authentication</p>
EAP password	<pre>network wireless eapPassword</pre> <p>When prompted to enter the password for EAP authentication, type the password.</p>
EAP CA certificate	<pre>network wireless eapCACertificate</pre> <p>When prompted to enter the CA certificate, open the certificate with a text editor, copy and paste the content into the communications program.</p>

The content to be copied from the CA certificate does NOT include the first line containing "BEGIN CERTIFICATE" and the final line containing "END CERTIFICATE." If a certificate is installed, configure the following:

Whether to	Use this command
Verify the certificate	<pre>network wireless enableCertVerification &lt;option1&gt;</pre> <p>&lt;option1&gt; = <i>true</i> or <i>false</i></p>
Accept an expired or not valid certificate	<pre>network wireless allowOffTimeRangeCerts &lt;option2&gt;</pre> <p>&lt;option2&gt; = <i>true</i> or <i>false</i></p>
Make the connection successful by ignoring the "incorrect" system time	<pre>network wireless allowConnectionWithIncorrectC lock &lt;option3&gt;</pre> <p>&lt;option3&gt; = <i>true</i> or <i>false</i></p>

- **Wireless IPv4 / IPv6 settings:**

Commands for wireless IP settings are identical to those for wired networking. Just replace the variable <ETH> with the word 'wireless'. The following illustrates a few examples.

To set or enable	Use this command
IPv4 configuration method	<pre>network ipv4 interface WIRELESS configMethod &lt;mode&gt;</pre> <p>&lt;mode&gt; = <i>dhcp</i> (default) or <i>static</i></p>
IPv6 configuration method	<pre>network ipv6 interface WIRELESS configMethod &lt;mode&gt;</pre> <p>&lt;mode&gt; = <i>automatic</i> (default) or <i>static</i></p>

- ▶ **To verify network settings:**

After exiting the above configuration mode and the # prompt re-appears, type this command to verify all network settings.

- `show network`



---

## Wireless LAN Information

The cascading chain can connect to a wired and/or wireless LAN in the Port Forwarding mode. See *Setting the Cascading Mode* (on page 8).

This appendix provides information regarding wireless LAN configuration and LAN adapters.

---

### Supported Wireless LAN Configuration

If wireless networking is preferred, ensure that the wireless LAN configuration of your Raritan device matches the access point. The following is the wireless LAN configuration that the Raritan device supports.

- Network type: 802.11 A/B/G/N
- Protocol: WPA2 (RSN)
- Key management: WPA-PSK, or WPA-EAP with PEAP and MSCHAPv2 authentication
- Encryption: CCMP (AES)

---

**Important: Supported 802.11 network protocols vary according to the wireless LAN adapter being used with the Raritan device. See *USB Wireless LAN Adapters* (on page 71).**

---

### USB Wireless LAN Adapters

A standalone Raritan device supports the use of all USB wireless LAN adapters below. However, the Port Forwarding mode only supports the use of the Raritan USB WIFI LAN adapter.

Wi-Fi LAN adapters	Supported 802.11 protocols
SparkLAN WUBR-508N	A/B/G/N
Proxim Orinoco 8494	A/B/G
Zyxel NWD271N	B/G
Edimax EW-7722UnD	A/B/G/N
TP-Link TL-WDN3200 v1	A/B/G/N
Raritan USB WIFI	A/B/G/N

---

*Note: To use the Edimax EW-7722UnD or Raritan USB WIFI wireless LAN adapter to connect to an 802.11n wireless network, the handshake timeout setting must be changed to 500 or greater, or the wireless connection will fail.*

---

# Index

## A

- Accessing Raritan Devices • 22
- Adding, Removing or Swapping Cascaded Devices • 21, 47
- Additional Information • 62
- Applicable Products • ix, x

## B

- Best Practices • x, 3

## C

- Cascading Applications • 1
- Cascading iX7™ Devices via Ethernet or USB • x, 5, 14, 18
- Cascading Modes • 6
- Cascading Procedure • 4
- Cascading Raritan Devices • x, 12
- Cascading Raritan devices via USB • x, 5, 14, 19
- Cascading Restrictions • x, 20
- Cascading Solution's Overview • 1
- Cascading Troubleshooting • 47, 55
- Character LCD Display • 25, 45
- Configuration via CLI • 66
- Configuration via Web Interface • 9, 65
- Configuring Network Settings • 64
- Connecting the Raritan device to a Computer • 8, 55, 62

## D

- Dot-Matrix LCD Display • x, 23, 24, 42

## E

- Extended Cascading (for iX7™ Devices Only) • x, 3, 16
- Extended-Cascading Requirements • x, 16

## F

- Finding the IP Address • x, 8, 22, 35
- Firmware Upgrade • 49

## H

- HTTP/HTTPS Access • 27, 35

## I

- Identifying Cascaded Devices • 35
- Illustration • 2
- Installing the USB-to-Serial Driver (Optional) • 63

## L

- LCD Display • 22
- Local Console • 26
- Login • 8, 27, 59

## M

- MAC Address • 27
- Making a Connection • 62
- Mode Change via CLI • 10
- Mode Change via Web Interface • x, 8

## O

- Overview of the Cascading Modes • x, 6

## P

- Ping via the CLI • 60
- Ping via the Web Interface • 59
- Port Forwarding Examples • 28, 31, 32
- Port Number Syntax • 7, 8, 30, 32, 57
- Port Numbers for Port-Forwarding Devices • 30, 65
- Possible Root Causes • x, 55

## S

- Safety Guidelines • ii
- Safety Instructions • iii
- Setting the Cascading Mode • x, 4, 8, 14, 18, 21, 36, 47, 71
- Slave Device Events in the Log • 58
- SNMP Management • 29
- SNMP Notifications • 29
- SSH/Telnet Access • 10, 28, 38, 60
- Supported Web Browsers • 27

Supported Wireless LAN Configuration • 56, 71

## T

The Ping Tool • 58

Third-Party SNMP Managers • 29

## U

Unsupported Cascading Connections for Port Forwarding • 18, 52, 58

Updating the Raritan device Firmware • 49

Upgrade Sequence in an Existing Cascading Chain • x, 13, 15, 20, 49, 50

USB Cascading • x, 12

USB Wireless LAN Adapters • 15, 20, 56, 71

USB-Cascading Requirements • x, 13, 14

Using the CLI • 38

Using the LCD Display • 42

Using the SNMP • 40

Using the Web Interface • 35

## W

What's New in the Cascading Guide • x

When to Avoid Cascading Devices • 4

Wireless LAN Information • 71