

PX3-1000/2000 Series

User Guide

Xerus™ Firmware v3.3.10

Safety Guidelines

WARNING! Read and understand all sections in this guide before installing or operating this product.

WARNING! Connect this product to an AC power source whose voltage is within the range specified on the product's nameplate. Operating this product outside the nameplate voltage range may result in electric shock, fire, personal injury and death.

WARNING! Connect this product to an AC power source that is current limited by a suitably rated fuse or circuit breaker in accordance with national and local electrical codes. Operating this product without proper current limiting may result in electric shock, fire, personal injury and death.

WARNING! Connect this product to a protective earth ground. Never use a "ground lift adaptor" between the product's plug and the wall receptacle. Failure to connect to a protective earth ground may result in electric shock, fire, personal injury and death.

WARNING! This product contains no user serviceable parts. Do not open, alter or disassemble this product. All servicing must be performed by qualified personnel. Disconnect power before servicing this product. Failure to comply with this warning may result in electric shock, personal injury and death.

WARNING! Use this product in a dry location. Failure to use this product in a dry location may result in electric shock, personal injury and death.

WARNING! Do not rely on this product's receptacle lamps, receptacle relay switches or any other receptacle power on/off indicator to determine whether power is being supplied to a receptacle. Unplug a device connected to this product before performing repair, maintenance or service on the device. Failure to unplug a device before servicing it may result in electric shock, fire, personal injury and death.

WARNING! Only use this product to power information technology equipment that has a UL/IEC 60950-1 or equivalent rating. Attempting to power non-rated devices may result in electric shock, fire, personal injury and death.

WARNING! Do not use a Raritan product containing outlet relays to power large inductive loads such as motors or compressors. Attempting to power a large inductive load may result in damage to the relay.

WARNING! Do not use this product to power critical patient care equipment, fire or smoke alarm systems. Use of this product to power such equipment may result in personal injury and death.

WARNING! If this product is a model that requires assembly of its line cord or plug, all such assembly must be performed by a licensed electrician and the line cord or plugs used must be suitably rated based on the product's nameplate ratings and national and local electrical codes. Assembly by unlicensed electricians or failure to use suitably rated line cords or plugs may result in electric shock, fire, personal injury or death.

WARNING! This product contains a chemical known to the State of California to cause cancer, birth defects, or other reproductive harm.

Safety Instructions

1. Installation of this product should only be performed by a person who has knowledge and experience with electric power.
2. Make sure the line cord is disconnected from power before physically mounting or moving the location of this product.
3. This product is designed to be used within an electronic equipment rack. The metal case of this product is electrically bonded to the line cord ground wire. A threaded grounding point on the case may be used as an additional means of protectively grounding this product and the rack.
4. Examine the branch circuit receptacle that will supply electric power to this product. Make sure the receptacle's power lines, neutral and protective earth ground pins are wired correctly and are the correct voltage and phase. Make sure the branch circuit receptacle is protected by a suitably rated fuse or circuit breaker.
5. If the product is a model that contains receptacles that can be switched on/off, electric power may still be present at a receptacle even when it is switched off.

This document contains proprietary information that is protected by copyright. All rights reserved. No part of this document may be photocopied, reproduced, or translated into another language without express prior written consent of Raritan, Inc.

© Copyright 2017 Raritan, Inc. All third-party software and hardware mentioned in this document are registered trademarks or trademarks of and are the property of their respective holders.

FreeType Project Copyright Notice

Portions of this software are copyright © 2015 The FreeType Project (www.freetype.org). All rights reserved.

FCC Information

This equipment has been tested and found to comply with the limits for a Class A digital device, pursuant to Part 15 of the FCC Rules. These limits are designed to provide reasonable protection against harmful interference in a commercial installation. This equipment generates, uses, and can radiate radio frequency energy and if not installed and used in accordance with the instructions, may cause harmful interference to radio communications. Operation of this equipment in a residential environment may cause harmful interference.

VCCI Information (Japan)

この装置は、クラスA情報技術装置です。この装置を家庭環境で使用すると電波妨害を引き起こすことがあります。この場合には使用者が適切な対策を講ずるよう要求されることがあります。 VCCI-A

Raritan is not responsible for damage to this product resulting from accident, disaster, misuse, abuse, non-Raritan modification of the product, or other events outside of Raritan's reasonable control or not arising under normal operating conditions.

If a power cable is included with this product, it must be used exclusively for this product.



Warning

This is a class A product. In a domestic environment this product may cause radio interference in which case the user may be required to take adequate measures.

CAUTION:



To reduce the risk of shock — Use indoors only in a dry location. No user serviceable parts inside. Refer servicing to qualified personnel. For use with IT equipment only. Disconnect power before servicing.



SecureLock™

Contents

Safety Guidelines	ii
<hr/>	
Safety Instructions	iii
<hr/>	
Applicable Models	xvii
<hr/>	
What's New in the PX3 User Guide	xix
<hr/>	
Chapter 1 Introduction	1
<hr/>	
Product Models.....	1
Package Contents.....	1
Zero U Products	2
1U Products.....	2
2U Products.....	2
APIPA and Link-Local Addressing	3
Before You Begin	4
Unpacking the Product and Components.....	4
Preparing the Installation Site.....	4
Checking the Branch Circuit Rating	4
Filling Out the Equipment Setup Worksheet.....	5
<hr/>	
Chapter 2 Rackmount, Inlet and Outlet Connections	6
<hr/>	
Circuit Breaker Orientation Limitation	6
Rack-Mounting the PDU.....	6
Rackmount Safety Guidelines.....	6
Mounting Zero U Models Using L-Brackets	7
Mounting Zero U Models Using Button Mount	9
Mounting Zero U Models Using Claw-Foot Brackets.....	10
Mounting Zero U Models Using Two Rear Buttons	12
Mounting Zero U Models Using L-Brackets and Buttons	13
Mounting 1U or 2U Models	14
Connecting a Locking Line Cord	16
Disconnecting a Locking Line Cord	17

Installing Cable Retention Clips on the Inlet (Optional)	18
Installing Cable Retention Clips on Outlets (Optional)	19
Locking Outlets and Cords	20
SecureLock™ Outlets and Cords	21
Button-Type Locking Outlets	22
Chapter 3 Initial Installation and Configuration	23
Connecting the PDU to a Power Source	23
Connecting the PX3 to Your Network	24
USB Wireless LAN Adapters	25
Supported Wireless LAN Configuration	26
Dual Ethernet Connection (for iX7™ Only)	27
Configuring the PX3	27
Connecting the PX3 to a Computer	28
Installing the USB-to-Serial Driver (Optional)	31
Initial Network Configuration via CLI	32
Bulk Configuration Methods	37
Cascading Multiple PX3 Devices for Sharing Ethernet Connectivity	38
Cascading the PX3 via USB	40
Extended Cascading with PX3-iX7 Models	42
Unsupported Cascading Connections for Port Forwarding	45
Power-Sharing Restrictions and Connection (for iX7™ Only)	47
Making a Power-Sharing Connection	49
Power-Sharing Configurations and Restrictions	50
Supported Sensor Configurations for Power Sharing	51
Chapter 4 Connecting External Equipment (Optional)	53
Connecting Environmental Sensor Packages	53
DPX Sensor Packages	54
DPX2 Sensor Packages	59
DPX3 Sensor Packages	61
DX Sensor Packages	63
Using an Optional DPX3-ENVHUB4 Sensor Hub	66
Mixing Diverse Sensor Types	68
Connecting Asset Management Strips	72
Combining Regular Asset Strips	72
Introduction to Asset Tags	74
Connecting Regular Asset Strips to PX3	74
Connecting Blade Extension Strips	76
Connecting Composite Asset Strips	79

Connecting a Logitech Webcam.....	81
Connecting a GSM Modem	82
Connecting an Analog Modem	83
Connecting an External Beeper	83
Connecting a Schroff LHX/SHX Heat Exchanger	84

Chapter 5 Introduction to PDU Components 85

Panel Components	85
Inlet	86
Outlets	87
Connection Ports.....	88
Dot-Matrix LCD Display	91
Reset Button	117
Circuit Breakers	118
Resetting the Button-Type Circuit Breaker.....	118
Resetting the Handle-Type Circuit Breaker	119
Fuse	120
Fuse Replacement on Zero U Models	120
Fuse Replacement on 1U Models	121
Beeper	123
Replaceable Controller	124

Chapter 6 Using the Web Interface 126

Supported Web Browsers	126
Login, Logout and Password Change.....	126
Login.....	127
Changing Your Password.....	128
Remembering User Names and Passwords	129
Logout	129
Web Interface Overview.....	129
Menu.....	132
Quick Access to a Specific Page	134
Sorting a List	134
Dashboard	135
Dashboard - Inlet I1	137
Dashboard - OCP	139
Dashboard - Alerted Sensors	140
Dashboard - Inlet History	142
Dashboard - Alarms.....	143
PDU	145
Internal Beeper State	148
PX3 Latching Relay Behavior	150
Options for Outlet State on Startup	150
Initialization Delay Use Cases.....	151

Inrush Current and Inrush Guard Delay	151
Z Coordinate Format	152
How the Automatic Management Function Works.....	152
Time Units	153
Setting Thresholds for Total Active Energy or Power	153
+12V Power Supply Sensor (for iX7™ Only)	154
Inlet	155
Configuring a Multi-Inlet Model.....	157
Outlets	158
Available Data of the Outlets Overview Page	162
Setting Outlet Power-On Sequence and Delay.....	162
Setting Non-Critical Outlets	163
Load Shedding Mode.....	164
Individual Outlet Pages	165
OCPs	170
Individual OCP Pages	172
Peripherals	175
Yellow- or Red-Highlighted Sensors	180
Managed vs Unmanaged Sensors/Actuators	181
Sensor/Actuator States.....	182
Finding the Sensor's Serial Number	184
Identifying the Sensor Position and Channel	185
Managing One Sensor or Actuator	186
Individual Sensor/Actuator Pages	188
Sensor/Actuator Location Example.....	192
Feature Port	193
Asset Strip.....	195
External Beeper	203
Schroff LHX/SHX	204
Power CIM.....	207
User Management	207
Creating Users	208
Editing or Deleting Users.....	212
Creating Roles.....	213
Editing or Deleting Roles	214
Setting Your Preferred Measurement Units	215
Setting Default Measurement Units	216
Device Settings	217
Configuring Network Settings	218
Configuring Network Services.....	239
Configuring Security Settings	247
Setting the Date and Time	269
Event Rules and Actions	272
Setting Data Logging.....	317
Configuring Data Push Settings	318
Monitoring Server Accessibility	320

Front Panel Settings	324
Configuring the Serial Port	325
Lua Scripts	327
Miscellaneous	332
Maintenance	333
Device Information	334
Viewing Connected Users	338
Viewing or Clearing the Local Event Log	339
Updating the PX3 Firmware	341
Viewing Firmware Update History	343
Bulk Configuration	344
Backup and Restore of Device Settings	347
Network Diagnostics	348
Downloading Diagnostic Information	349
Rebooting the PX3 Device	350
Resetting All Settings to Factory Defaults	350
Retrieving Software Packages Information	351
Webcam Management	352
Configuring Webcams and Viewing Live Images	352
Sending Snapshots or Videos in an Email or Instant Message	354
Viewing Saved Snapshots and Managing Storage	355

Chapter 7 Using SNMP 357

Enabling and Configuring SNMP	357
SNMPv2c Notifications	358
SNMPv3 Notifications	359
Downloading SNMP MIB	360
SNMP Gets and Sets	361
The PX3 MIB	361
A Note about Enabling Thresholds	364

Chapter 8 Using the Command Line Interface 365

About the Interface	365
Logging in to CLI	366
With HyperTerminal	366
With SSH or Telnet	367
With an Analog Modem	368
Different CLI Modes and Prompts	368
Closing a Local Connection	369
Help Command	369
Querying Available Parameters for a Command	370
Showing Information	370
Network Configuration	371
PDU Configuration	375

Outlet Information.....	375
Inlet Information	376
Overcurrent Protector Information	377
Date and Time Settings.....	378
Default Measurement Units.....	378
Environmental Sensor Information	379
Environmental Sensor Package Information	380
Actuator Information.....	381
Outlet Sensor Threshold Information.....	382
Outlet Pole Sensor Threshold Information	383
Inlet Sensor Threshold Information	384
Inlet Pole Sensor Threshold Information	385
Overcurrent Protector Sensor Threshold Information	386
Environmental Sensor Threshold Information.....	388
Environmental Sensor Default Thresholds	389
Security Settings	390
Existing User Profiles	391
Existing Roles.....	392
Load Shedding Settings	392
Serial Port Settings.....	393
EnergyWise Settings	393
Asset Strip Settings	393
Rack Unit Settings of an Asset Strip.....	394
Blade Extension Strip Settings	395
Event Log.....	396
Wireless LAN Diagnostic Log	397
Server Reachability Information.....	397
Command History	399
History Buffer Length	399
Reliability Data	399
Reliability Error Log.....	399
Examples.....	400
Clearing Information	402
Clearing Event Log.....	402
Clearing WLAN Log.....	403
Configuring the PX3 Device and Network	403
Entering Configuration Mode.....	403
Quitting Configuration Mode	404
PDU Configuration Commands.....	404
Network Configuration Commands.....	412
Time Configuration Commands.....	438
Checking the Accessibility of NTP Servers	443
Security Configuration Commands.....	443
Outlet Configuration Commands	464
Inlet Configuration Commands.....	465
Overcurrent Protector Configuration Commands.....	467

Contents

- User Configuration Commands 467
- Role Configuration Commands..... 481
- Environmental Sensor Configuration Commands 486
- Configuring Environmental Sensors' Default Thresholds 491
- Sensor Threshold Configuration Commands..... 493
- Actuator Configuration Commands..... 504
- Server Reachability Configuration Commands 505
- EnergyWise Configuration Commands..... 509
- Asset Management Commands..... 511
- Serial Port Configuration Commands 518
- Setting the History Buffer Length..... 519
- Multi-Command Syntax 520
- Load Shedding Configuration Commands 521
 - Enabling or Disabling Load Shedding..... 522
- Power Control Operations..... 523
 - Turning On the Outlet(s) 523
 - Turning Off the Outlet(s) 524
 - Power Cycling the Outlet(s) 525
 - Canceling the Power-On Process..... 526
 - Example - Power Cycling Specific Outlets 526
- Actuator Control Operations 526
 - Switching On an Actuator..... 527
 - Switching Off an Actuator 527
 - Example - Turning On a Specific Actuator 528
- Unblocking a User 528
- Resetting the PX3 528
 - Restarting the PDU 529
 - Resetting Active Energy Readings..... 529
 - Resetting to Factory Defaults 530
- Network Troubleshooting..... 530
 - Entering Diagnostic Mode..... 530
 - Quitting Diagnostic Mode..... 531
 - Diagnostic Commands 531

Retrieving Previous Commands.....	533
Automatically Completing a Command	533
Logging out of CLI.....	534
Chapter 9 Using SCP Commands	535
<hr/>	
Firmware Update via SCP	535
Bulk Configuration via SCP	536
Backup and Restore via SCP	537
Downloading Diagnostic Data via SCP	538
Appendix A Specifications	540
<hr/>	
Maximum Ambient Operating Temperature.....	540
Serial RS-232 "DB9" Port Pinouts	540
Serial RS-232 "RJ-45" Port Pinouts (for iX7™ Only).....	541
Sensor RJ-45 Port Pinouts.....	541
Feature RJ-45 Port Pinouts	542
Expansion RJ-45 Port Pinouts (for iX7™ Only).....	542
Appendix B Equipment Setup Worksheet	544
<hr/>	
Appendix C Configuration or Firmware Upgrade with a USB Drive	548
<hr/>	
Device Configuration/Upgrade Procedure.....	548
System and USB Requirements.....	549
Configuration Files	550
fwupdate.cfg.....	551
config.txt.....	555
devices.csv	557
Creating Configuration Files via Mass Deployment Utility	558
Data Encryption in 'config.txt'	559

Firmware Upgrade via USB.....	560
Appendix D Bulk Configuration or Firmware Upgrade via DHCP/TFTP	562
<hr/>	
Bulk Configuration/Upgrade Procedure	562
TFTP Requirements.....	563
DHCP IPv4 Configuration in Windows	564
DHCP IPv6 Configuration in Windows	574
DHCP IPv4 Configuration in Linux.....	581
DHCP IPv6 Configuration in Linux.....	583
Appendix E Resetting to Factory Defaults	585
<hr/>	
Using the Reset Button	585
Using the CLI Command	586
Appendix F PX3 Models with Residual Current Monitoring	588
<hr/>	
RCM Current Sensor	588
RCM State Sensor.....	589
Compliance with IEC 62020	590
RCM Self-Test.....	591
Web Interface Operations for RCM	591
Checking RCM State and Current.....	591
Setting RCM Current Thresholds	592
Scheduling RCM Self-Test	593
Disabling or Enabling Front Panel RCM Self-Test.....	593
Front Panel Operations for RCM.....	594
LCD Message for RCM Critical State.....	594
Checking RCM States and Current.....	595
Running RCM Self-Test	596
RCM SNMP Operations	597
RCM Trap.....	597
RCM Residual Current and State Objects	598
Setting RCM Thresholds	598
Running RCM Self-Test	598
CLI Operations for RCM.....	598
Showing Residual Current Monitor Information	599
Setting RCM Current Thresholds	599
Setting Front Panel RCM Self-Test	600
Running RCM Self-Test	601
Degaussing RCM Type B Sensors.....	601

Appendix G Old PX3 Character LCD Display 602

Overview of the LCD Display	603
Control Buttons	604
Operating the LCD Display	604
Outlet Information.....	604
Inlet Information	606
Overcurrent Protector Information	607
IPv4 Address	609
MAC Address.....	610
Outlet Switching.....	611
Environmental Sensor Information	613
Asset Strip Information.....	615
USB-Cascaded Device's Position	617
RCM Information.....	618

Appendix H LDAP Configuration Illustration 621

Step A. Determine User Accounts and Roles	621
Step B. Configure User Groups on the AD Server	622
Step C. Configure LDAP Authentication on the PX3 Device.....	623
Step D. Configure Roles on the PX3 Device	624

Appendix I Updating the LDAP Schema 627

Returning User Group Information	627
From LDAP/LDAPS	627
From Microsoft Active Directory.....	627
Setting the Registry to Permit Write Operations to the Schema.....	628
Creating a New Attribute.....	628
Adding Attributes to the Class	629
Updating the Schema Cache	631
Editing rciusergroup Attributes for User Members	631

Appendix J RADIUS Configuration Illustration 634

Standard Attributes	634
NPS Standard Attribute Illustration	634
FreeRADIUS Standard Attribute Illustration	652
Vendor-Specific Attributes	653
NPS VSA Illustration	653
FreeRADIUS VSA Illustration.....	665

AD-Related Configuration 666

Appendix K Additional PX3 Information 670

RJ45-to-DB9 Cable Requirements for Modem Connections (for iX7™ Only) 670

Reserving IP Addresses in DHCP Servers 671

 Reserving IP in Windows..... 672

 Reserving IP in Linux 673

Sensor Threshold Settings..... 675

 Thresholds and Sensor States..... 675

 “To Assert” and Assertion Timeout 678

 “To De-assert” and Deassertion Hysteresis 680

PDView App for Viewing the PX3 682

Altitude Correction Factors..... 684

Unbalanced Current Calculation..... 685

Data for BTU Calculation..... 686

Ways to Probe Existing User Profiles 687

Raritan Training Website..... 687

Role of a DNS Server 688

Cascading Troubleshooting..... 688

 Possible Root Causes 688

 Slave Connection and Disconnection Events..... 691

 The Ping Tool..... 692

Browsing through the Online Help..... 694

Appendix L Integration 696

Dominion KX II / III Configuration..... 696

 Configuring Rack PDU Targets..... 697

 Turning Outlets On/Off and Cycling Power..... 700

Dominion KSX II, SX or SX II Configuration 701

 Dominion KSX II..... 701

 Dominion SX and SX II 703

Power IQ Configuration 706

dcTrack 707

 dcTrack Overview..... 708

 Asset Management Strips and dcTrack..... 709

Index 711

Applicable Models

This User Guide is applicable to all the following PDU Generations.











- PX3 PDU Generation (1000/2000 series)
- PX3 with iX7™ PDU Generation (1000/2000 series)

Any PX Generations can be associated with existing metering families called “Series”, from 1000 series to 5000 series.





For example, PX2-4000, PX3-4000 series and PX3-iX7-4000 series are all inlet metered and outlet metered PDUs, but have different controller generations.

*Note: For information on other PX2, PX3 or PX3-iX7 models, see their respective Online Help or User Guide on the Raritan website's **Support** page (<http://www.raritan.com/support/>).*

► **PX models comparison in brief:**

Features	Inlet power measurement	Outlet power measurement	Outlet switching	Load shedding
1000 Series				
2000 Series				
3000 Series (Inline meters)				
4000 Series				
5000 Series				

► Comparison between PX2, PX3 and PX3-iX7:

Features	Front panel display	Outlet latching relays	Number of USB-A ports	SENSOR port type	Replaceable controller
PX2 Series	LED display		1	RJ-12	
PX3 phase I Series	Character LCD display	 *	2	RJ-45	***
PX3 phase II Series	Dot-matrix LCD display	 *	2	RJ-45	 **
PX3 with iX7 Controller	Dot-matrix LCD display	 *	2	RJ-45	 **

* Only PX3 models with outlet switching have outlet latching relays.

** Only PX3 "Zero U" (phase II and iX7™) have the replaceable controller.

*** PX3 phase I models do NOT support a replaceable controller and are NOT available for sale anymore.

► Comparison (continued):

Features	Number of LAN ports	Expansion ports	RS-232 port (CONSOLE / MODEM)
PX2 Series	1		Male DB9 Connector
PX3 phase I Series	1		Male DB9 Connector
PX3 phase II Series	1		Male DB9 Connector
PX3 with iX7 Controller	2		Female RJ-45 Connector

What's New in the PX3 User Guide

The following sections have changed or information has been added to the PX3 User Guide based on enhancements and changes to the equipment and/or user documentation.

Applicable Models (on page xvii)

USB Wireless LAN Adapters (on page 25)

Dual Ethernet Connection (for iX7[™] Only) (on page 27)

Connecting the PX3 to a Computer (on page 28)

Initial Network Configuration via CLI (on page 32)

Cascading Multiple PX3 Devices for Sharing Ethernet Connectivity (on page 38)

Cascading the PX3 via USB (on page 40)

Extended Cascading with PX3-iX7 Models (on page 42)

Unsupported Cascading Connections for Port Forwarding (on page 45)

Power-Sharing Restrictions and Connection (for iX7[™] Only) (on page 47)

Making a Power-Sharing Connection (on page 49)

Power-Sharing Configurations and Restrictions (on page 50)

Supported Sensor Configurations for Power Sharing (on page 51)

Introduction to Asset Tags (on page 74)

Connecting a Logitech Webcam (on page 81)

Connecting a GSM Modem (on page 82)

Connecting an Analog Modem (on page 83)

Zero U Connection Ports (on page 88)

Connection Port Functions (on page 89)

PDU (on page 99)

Device Info (on page 111)

Menu (on page 132)

Dashboard - OCP (on page 139)

PDU (on page 145)

+12V Power Supply Sensor (for iX7[™] Only) (on page 154)

Outlets (on page 158)

Setting Non-Critical Outlets (on page 163)

Individual OCP Pages (on page 172)

Asset Strip (on page 195)
Creating Users (on page 208)
Creating Roles (on page 213)
User Interfaces Showing Default Units (on page 216)
Device Settings (on page 217)
Configuring Network Settings (on page 218)
Wired Network Settings (on page 219)
Common Network Settings (on page 220)
Ethernet Interface Settings (on page 221)
Wireless Network Settings (on page 222)
Static Route Examples (on page 227)
Interface Names (on page 230)
Setting the Cascading Mode (on page 231)
Overview of the Cascading Modes (on page 233)
Configuring SMTP Settings (on page 242)
Editing or Deleting IP Access Control Rules (on page 249)
Editing or Deleting Role Access Control Rules (on page 251)
Setting Up an SSL/TLS Certificate (on page 252)
Installing a CA-Signed Certificate (on page 254)
Adding LDAP/LDAPS Servers (on page 260)
Managing External Authentication Settings (on page 265)
Event Rules and Actions (on page 272)
Built-in Rules and Rule Configuration (on page 273)
Default Log Messages (on page 278)
Available Actions (on page 289)
Alarm (on page 291)
Action Group (on page 292)
Request LHX/SHX Maximum Cooling (on page 296)
Send Sensor Report (on page 297)
Send an SNMP Notification (on page 300)
Start or Stop a Lua Script (on page 302)
Email and SMS Message Placeholders (on page 309)
Example 3 (on page 316)
Setting Data Logging (on page 317)
Configuring Data Push Settings (on page 318)

Configuring the Serial Port (on page 325)
Lua Scripts (on page 327)
Writing or Loading a Lua Script (on page 327)
Manually Starting or Stopping a Script (on page 329)
Checking Lua Scripts States (on page 331)
Modifying or Deleting a Script (on page 331)
Device Information (on page 334)
Identifying Cascaded Devices (on page 335)
Updating the PX3 Firmware (on page 341)
Upgrade Guidelines for Existing USB-Cascading Chains (on page 342)
Full Disaster Recovery (on page 343)
Bulk Configuration (on page 344)
Backup and Restore of Device Settings (on page 347)
Rebooting the PX3 Device (on page 350)
Resetting All Settings to Factory Defaults (on page 350)
Network Configuration (on page 371)
IP Configuration (on page 371)
IPv4-Only or IPv6-Only Configuration (on page 372)
Network Interface Settings (on page 373)
Configuring IPv4 Parameters (on page 412)
Setting the IPv4 Configuration Mode (on page 412)
Setting the IPv4 Preferred Host Name (on page 413)
Setting the IPv4 Address (on page 414)
Setting the IPv4 Gateway (on page 415)
Setting IPv4 Static Routes (on page 415)
Setting the IPv6 Configuration Mode (on page 416)
Setting the IPv6 Preferred Host Name (on page 417)
Setting the IPv6 Address (on page 418)
Setting the IPv6 Gateway (on page 419)
Setting IPv6 Static Routes (on page 419)
Configuring DNS Parameters (on page 421)
Setting LAN Interface Parameters (on page 421)
Enabling or Disabling the LAN Interface (on page 422)
Changing the LAN Interface Speed (on page 422)

- Changing the LAN Duplex Mode* (on page 423)
- Configuring the Cascading Mode* (on page 429)
- Deleting an NTP Server* (on page 440)
- RCM Critical State Alarm* (on page 592)
- Setting RCM Current Thresholds* (on page 592)
- IPv4 Address* (on page 609)
- USB-Cascaded Device's Position* (on page 617)
- Step C. Configure LDAP Authentication on the PX3 Device* (on page 623)
- Reserving IP Addresses in DHCP Servers* (on page 671)
- Reserving IP in Windows* (on page 672)
- Reserving IP in Linux* (on page 673)
- "To Assert" and Assertion Timeout* (on page 678)
- "To De-assert" and Deassertion Hysteresis* (on page 680)
- Cascading Troubleshooting* (on page 688)
- Possible Root Causes* (on page 688)
- Slave Connection and Disconnection Events* (on page 691)
- Dominion SX II* (on page 703)

Please see the Release Notes for a more detailed explanation of the changes applied to this version of PX3.

Chapter 1 Introduction

In this User Guide, PX3 refers to both PX3 and “PX3 with iX7™ controller” unless otherwise specified. The PX3 with iX7™ controller is also called PX3-iX7 or iX7™ in the User Guide.

Raritan PX3 is an intelligent power distribution unit (PDU) that allows you to reboot remote servers and other network devices and/or to monitor power in the data center.

The intended use of the Raritan PX3 is distribution of power to information technology equipment such as computers and communication equipment where such equipment is typically mounted in an equipment rack located in an information technology equipment room.

Raritan offers different types of PX3 units -- some are outlet-switching capable, and some are not. With the outlet-switching function, you can recover systems remotely in the event of system failure and/or system lockup, eliminate the need to perform manual intervention or dispatch field personnel, reduce downtime and mean time to repair, and increase productivity.

In This Chapter

Product Models	1
Package Contents.....	1
APIPA and Link-Local Addressing	3
Before You Begin	4

Product Models

The PX3 comes in several models that are built to stock and can be obtained almost immediately. Raritan also offers custom models that are built to order and can only be obtained on request.

Download the PX3 Data Sheet from Raritan's website, visit the ***Product Selector page*** (<http://www.findmypdu.com/>) on Raritan's website, or contact your local reseller for a list of available models.

Package Contents

The following sub-topics describe the equipment and other material included in the product package.

Zero U Products

- The PX3 device
- Screws, brackets and/or buttons for Zero U
- Cable retention clips for the inlet (for some models only)
- Cable retention clips for outlets (for some models only)
- An "optional" null-modem cable with DB9 connectors on both ends (Raritan number: 254-01-0006-00) -- for PX3 models

For **PX3-iX7**, use a third party RJ45-to-DB9 adapter/cable instead of the null-modem cable. See ***RJ45-to-DB9 Cable Requirements for Computer Connections (for iX7[™] Only)*** (on page 30).

1U Products

- The PX3 device
- 1U bracket pack and screws
- Cable retention clips for the inlet (for some models only)
- An "optional" null-modem cable with DB9 connectors on both ends (Raritan number: 254-01-0006-00) -- for PX3 models

For **PX3-iX7**, use a third party RJ45-to-DB9 adapter/cable instead of the null-modem cable. See ***RJ45-to-DB9 Cable Requirements for Computer Connections (for iX7[™] Only)*** (on page 30).

2U Products

- The PX3 device
- 2U bracket pack and screws
- Cable retention clips for the inlet (for some models only)
- An "optional" null-modem cable with DB9 connectors on both ends (Raritan number: 254-01-0006-00) -- for PX3

For **PX3-iX7**, use a third party RJ45-to-DB9 adapter/cable instead of the null-modem cable. See ***RJ45-to-DB9 Cable Requirements for Computer Connections (for iX7[™] Only)*** (on page 30).

APIPA and Link-Local Addressing

The PX3 supports Automatic Private Internet Protocol Addressing (APIPA).

With APIPA, your PX3 automatically configures a link-local IP address and a link-local host name when it cannot obtain a valid IP address from any DHCP server in the TCP/IP network.

Only IT devices connected to *the same subnet* can access the PX3 using the link-local address/host name. Those in a different subnet cannot access it.

*Exception: The PX3 in the Port Forwarding mode does not support APIPA. See **Setting the Cascading Mode** (on page 231).*

Once the PX3 can get a DHCP-assigned IP address, it stops using APIPA and the link-local address is replaced by the DHCP-assigned address.

▶ **Scenarios where APIPA applies:**

- DHCP is enabled on the PX3, but no IP address is assigned to the PX3.

This may be caused by the absence or malfunction of DHCP servers in the network.

*Note: Configuration by connecting the PX3 to a computer using a network cable is an application of this scenario. See **Connecting the PX3 to a Computer** (on page 28).*

- The PX3 previously obtained an IP address from the DHCP server, but the lease of this IP address has expired, and the lease cannot be renewed, or no new IP address is available.

▶ **Link-local addressing:**

- IPv4 address:

Factory default is to enable IPv4 only. The link-local IPv4 address is *169.254.x.x/16*, which ranges between 169.254.1.0 and 169.254.254.255.

- IPv6 address:

A link-local IPv6 address is available only after IPv6 is enabled on the PX3. See **Configuring Network Settings** (on page 218).

- Host name - **pdu.local**:

You can type *https://pdu.local* to access the PX3 instead of typing the link-local IP address.

For retrieval of the link-local address, see **Device Info** (on page 111).

Before You Begin

Before beginning the installation, perform the following activities:

- Unpack the product and components
- Prepare the installation site
- Check the branch circuit rating
- Fill out the equipment setup worksheet

Unpacking the Product and Components

1. Remove the PX3 device and other equipment from the box in which they were shipped. See **Package Contents** (on page 1) for a complete list of the contents of the box.
2. Compare the serial number of the equipment with the number on the packing slip located on the outside of the box and make sure they match.
3. Inspect the equipment carefully. If any of the equipment is damaged or missing, contact Raritan's Technical Support Department for assistance.
4. Verify that all circuit breakers on the PX3 device are set to ON. If not, turn them ON.

Or make sure that all fuses are inserted and seated properly. If there are any fuse covers, ensure that they are closed.

Note: Not all PX3 devices have overcurrent protection mechanisms.

Preparing the Installation Site

1. Make sure the installation area is clean and free of extreme temperatures and humidity.

*Note: If necessary, contact Raritan Technical Support for the maximum operating temperature for your model. See **Maximum Ambient Operating Temperature** (on page 540).*

2. Allow sufficient space around the PX3 device for cabling and outlet connections.
3. Review **Safety Instructions** (on page iii) listed in this User Guide.

Checking the Branch Circuit Rating

The rating of the branch circuit supplying power to the PDU shall be in accordance with national and local electrical codes.

Filling Out the Equipment Setup Worksheet

An Equipment Setup Worksheet is provided in this User Guide. See *Equipment Setup Worksheet* (on page 544). Use this worksheet to record the model, serial number, and use of each IT device connected to the PDU.

As you add and remove devices, keep the worksheet up-to-date.

Chapter 2 Rackmount, Inlet and Outlet Connections

In This Chapter

Circuit Breaker Orientation Limitation	6
Rack-Mounting the PDU.....	6
Connecting a Locking Line Cord	16
Installing Cable Retention Clips on the Inlet (Optional)	18
Installing Cable Retention Clips on Outlets (Optional)	19
Locking Outlets and Cords.....	20

Circuit Breaker Orientation Limitation

Usually a PDU can be mounted in any orientation. However, when mounting a PDU with circuit breakers, you must obey these rules:

- Circuit breakers CANNOT face down. For example, do not horizontally mount a Zero U PDU with circuit breakers on the ceiling.
- If a rack is subject to shock in environments such as boats or airplanes, the PDU CANNOT be mounted upside down. If installed upside down, shock stress reduces the trip point by 10%.

Note: If normally the line cord is down, upside down means the line cord is up.

Rack-Mounting the PDU

This chapter describes how to rack mount a PX3 device. To mount a Zero U PX-1000 series PDU, you can use either two buttons or L-brackets that Raritan provided.

Rackmount Safety Guidelines

In Raritan products which require rack mounting, follow these precautions:

- Operation temperature in a closed rack environment may be greater than room temperature. Do not exceed the rated maximum ambient temperature of the Power Distribution Units. See *Specifications* (on page 540) in the User Guide.
- Ensure sufficient airflow through the rack environment.
- Mount equipment in the rack carefully to avoid uneven mechanical loading.

- Connect equipment to the supply circuit carefully to avoid overloading circuits.
- Ground all equipment properly, especially supply connections, to the branch circuit.

Mounting Zero U Models Using L-Brackets

If your PDU has circuit breakers implemented, read *Circuit Breaker Orientation Limitation* (on page 6) before mounting it.

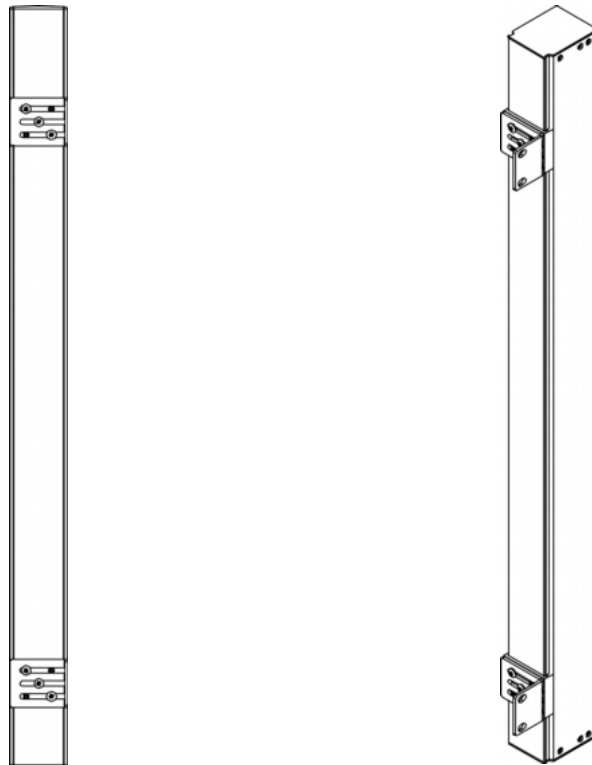

► **To mount Zero U models using L-brackets:**

1. Align the baseplates on the rear of the PX3 device.
2. Secure the baseplates in place. Use the included L-shaped hex key to loosen the hex socket screws until the baseplate is "slightly" fastened.

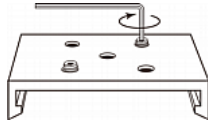

3. Align the L-brackets with the baseplates so that the five screw-holes on the baseplates line up through the L-bracket's slots. The rackmount side of brackets should face either the left or right side of the PX3 device.
4. Fasten the brackets in place with at least three screws (one through each slot). Use additional screws as desired.

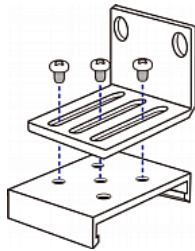

5. Using rack screws, fasten the PX3 device to the rack through the L-brackets.

Mounting Zero U Models Using Button Mount

If your PDU has circuit breakers implemented, read *Circuit Breaker Orientation Limitation* (on page 6) before mounting it.

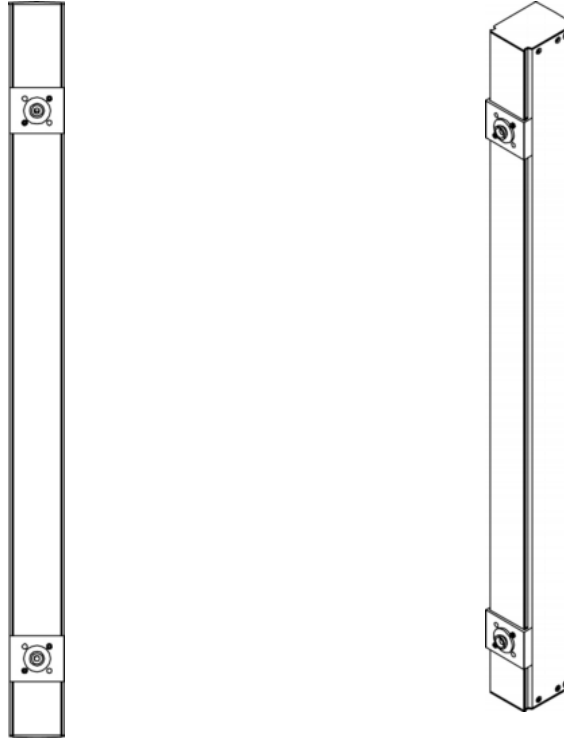

► **To mount Zero-U models using button mount:**

1. Align the baseplates on the rear of the PX3 device. Leave at least 24 inches between the baseplates for stability.
2. Make the baseplates grasp the device lightly. Use the included L-shaped hex key to loosen the hex socket screws until the baseplate is "slightly" fastened.
3. Screw each mounting button in the center of each baseplate. The recommended torque for the button is 1.96 N·m (20 kgf·cm).

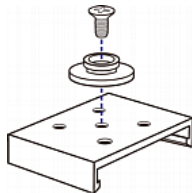

4. Align the large mounting buttons with the mounting holes in the cabinet, fixing one in place and adjusting the other.

5. Loosen the hex socket screws until the mounting buttons are secured in their position.
6. Ensure that both buttons can engage their mounting holes simultaneously.
7. Press the PX3 device forward, pushing the mounting buttons through the mounting holes, then letting the device drop about 5/8". This secures the PX3 device in place and completes the installation.

Mounting Zero U Models Using Claw-Foot Brackets

If your PDU has circuit breakers implemented, read *Circuit Breaker Orientation Limitation* (on page 6) before mounting it.

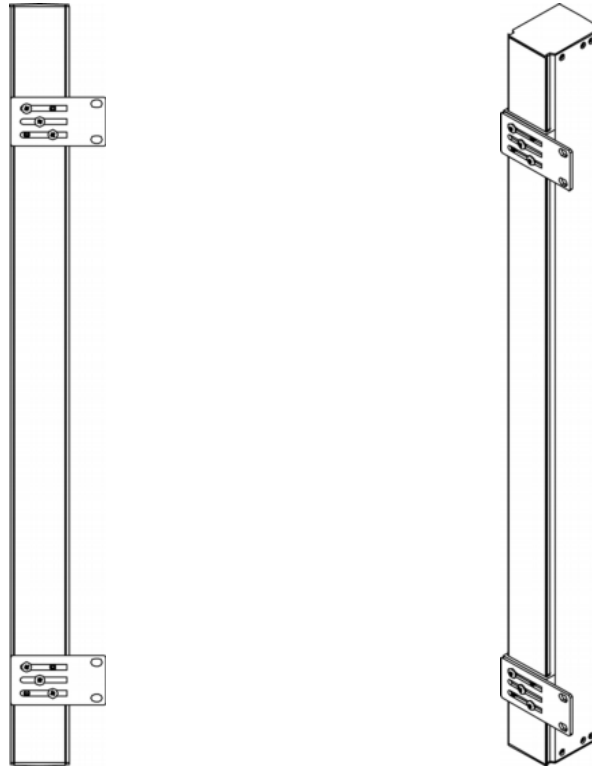

► **To mount Zero U models using claw-foot brackets:**

1. Align the baseplates on the rear of the PX3 device.
2. Secure the baseplates in place. Use the included L-shaped hex key to loosen the hex socket screws until the baseplate is "slightly" fastened.

3. Align the claw-foot brackets with the baseplates so that the five screw-holes on the baseplates line up through the bracket's slots. The rackmount side of brackets should face either the left or right side of the PX3 device.
4. Fasten the brackets in place with at least three screws (one through each slot). Use additional screws as desired.

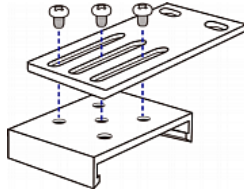

5. Using rack screws, fasten the PX3 device to the rack through the claw-foot brackets.

Mounting Zero U Models Using Two Rear Buttons

The following describes how to mount a PDU using two buttons only. If your PDU has circuit breakers implemented, read ***Circuit Breaker Orientation Limitation*** (on page 6) before mounting it.

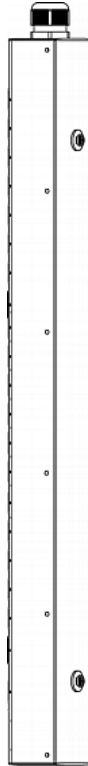

► **To mount Zero U models using two buttons:**

1. Turn to the rear of the PDU.
2. Locate two screw holes on the rear panel: one near the bottom and the other near the top (the side of cable gland).
3. Screw a button in the screw hole near the bottom. The recommended torque for the button is 1.96 N·m (20 kgf·cm).

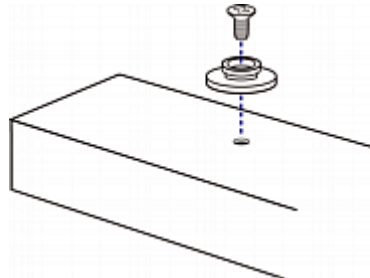

4. Screw a button in the screw hole near the top. The recommended torque for the button is 1.96 N·m (20 kgf·cm).
5. Ensure that the two buttons can engage their mounting holes in the rack or cabinet simultaneously.
6. Press the PX3 device forward, pushing the mounting buttons through the mounting holes, then letting the device drop slightly. This secures the PX3 device in place and completes the installation.

Mounting Zero U Models Using L-Brackets and Buttons

This section describes how to mount a PDU using L-brackets and two buttons. If your PDU has circuit breakers implemented, read ***Circuit Breaker Orientation Limitation*** (on page 6) before mounting it.

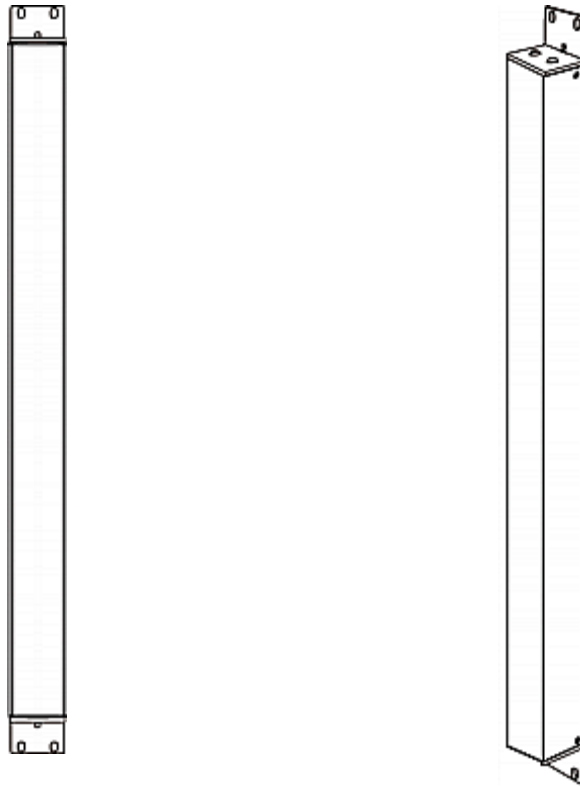

► **To mount Zero U models using L-brackets and two buttons:**

1. Align the two central holes of the L-bracket with the two screw holes on the top of the PX3 device.

2. Screw the L-bracket to the device and ensure the bracket is fastened securely.

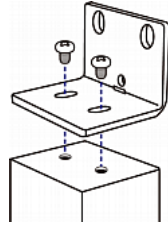

3. Repeat Steps 1 to 2 to screw another L-bracket to the bottom of the device.
4. After both L-brackets are installed, you can choose either of the following ways to mount the device in the rack.
 - Using rack screws, fasten the device to the rack through two identical holes near the edge of each L-bracket.
 - Mount the device by screwing a mounting button in the back center of each L-bracket and then having both buttons engage the mounting holes in the rack. The recommended torque for the button is 1.96 N·m (20 kgf·cm).

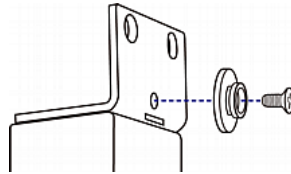

Mounting 1U or 2U Models

Using the appropriate brackets and tools, fasten the 1U or 2U device to the rack or cabinet.

► **To mount the PX3 device:**

1. Attach a rackmount bracket to both sides of the PX3 with the provided screws.

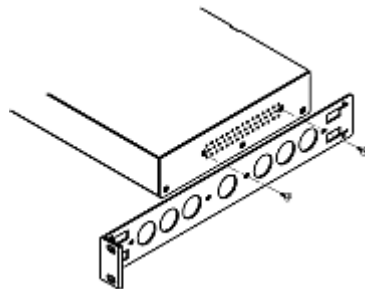

2. Insert the cable-support bar into rackmount brackets.

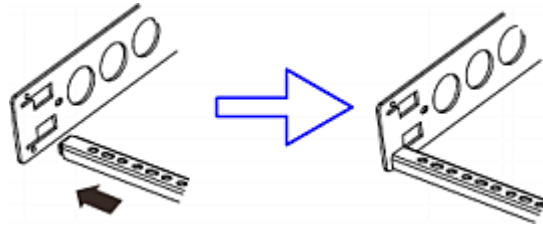

3. Secure with the provided end cap screws.

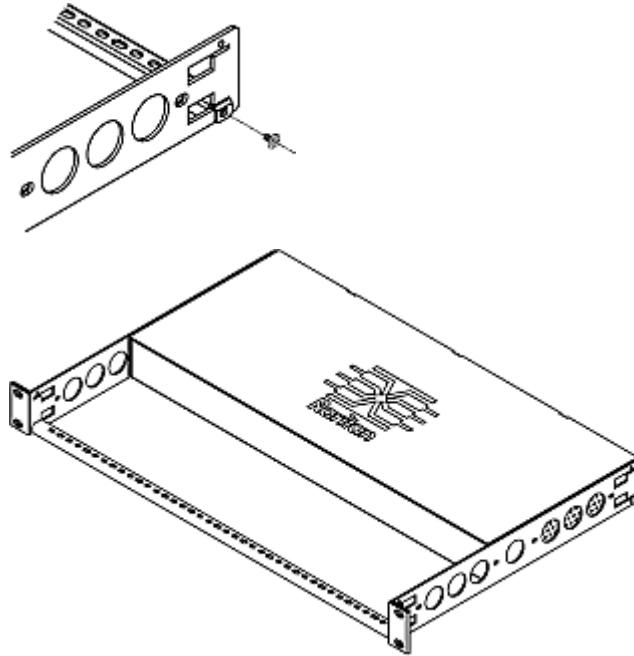

4. Fasten the rackmount brackets' ears to the rack using your own fasteners.

Connecting a Locking Line Cord

The PX3 is shipped with either of the following locking line cords.

- A line cord with locking clips: A locking inlet on the PDU is required for this cord.
- A line cord with slide release buttons: This line cord automatically locks after being connected to the inlet. A locking inlet is not required for this cord.

A locking inlet and/or locking line cord ensure that the line cord is securely fastened to the inlet.

► **To connect a cord with locking clips:**

Make sure the line cord's locking clips fit into the locking holes at two sides of the inlet when plugging the cord's connector into the PDU's locking inlet.

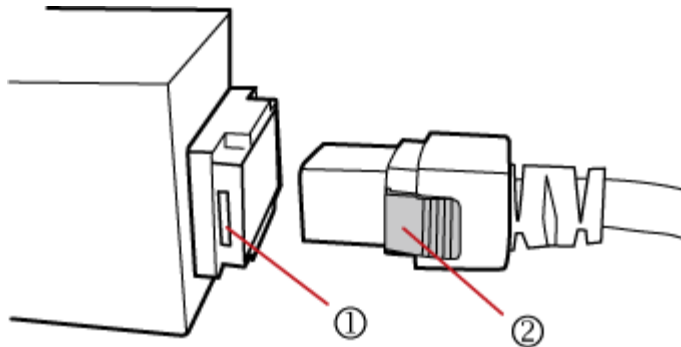

Number	Item
1	Locking holes on the inlet
2	Locking clips of the line cord

► **To connect a cord with slide release buttons:**

Simply plug the cord's connector into the PDU's inlet.

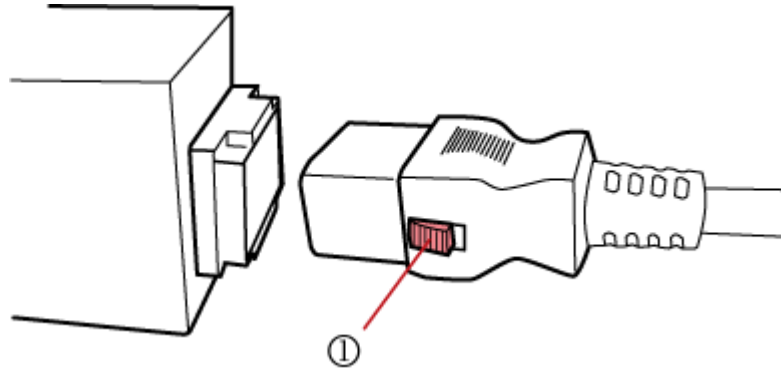

Number	Item
1	Slide release buttons

For information on removing the locking line cord, see *Disconnecting a Locking Line Cord* (on page 17).

Disconnecting a Locking Line Cord

The ways to disconnect a locking line cord vary according to the cord type.

► **To disconnect a line cord with locking clips:**

Press both locking clips of the line cord while unplugging the cord.

Tip: You can slightly move the line cord's plug horizontally while pulling it out to facilitate the disconnection process.

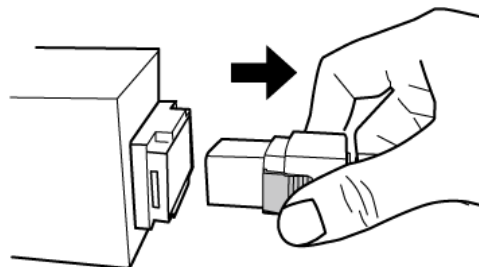

► **To disconnect a line cord with slide release buttons:**

Push both slide release buttons toward the cord while unplugging this cord.

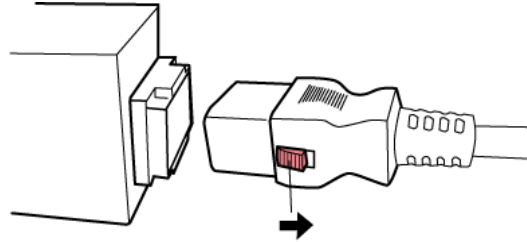

Installing Cable Retention Clips on the Inlet (Optional)

If your PX3 device is designed to use a cable retention clip, install the clip before connecting a power cord. A cable retention clip prevents the connected power cord from coming loose or falling off.

The use of cable retention clips is highly recommended for regions with high seismic activities, and environments where shocks and vibrations are expected.



► **To install and use a cable retention clip on the inlet:**

1. Locate two tiny holes adjacent to the inlet.
2. Install the cable retention clip by inserting two ends of the clip into the tiny holes.

Zero U models

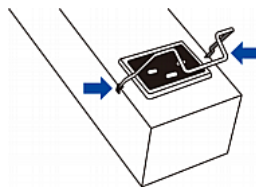

1U/2U models

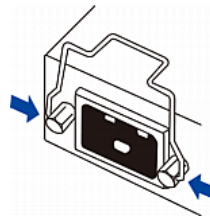

3. Connect the power cord to the inlet, and press the clip toward the power cord until it holds the cord firmly.

Zero U models

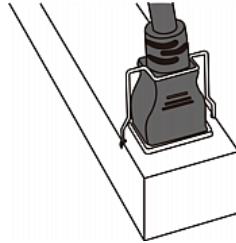

1U/2U models

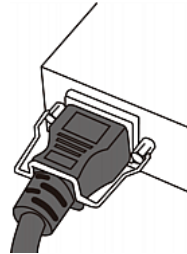

Installing Cable Retention Clips on Outlets (Optional)

If your PX3 device is designed to use a cable retention clip, install the clip before connecting a power cord. A cable retention clip prevents the connected power cord from coming loose or falling off.

The use of cable retention clips is highly recommended for regions with high seismic activities, and environments where shocks and vibrations are expected.

These optional clips come in various sizes to accommodate diverse power cords used on IT equipment, which are connected to C13 or C19 outlets. You can request a cable retention kit containing different sizes of clips from your reseller. Make sure you use a clip that fits the power cord snugly to facilitate the installation or removal operation (for servicing).



*Note: Some NEMA sockets on PSE-certified PDUs for Japan have integral locking capability and do not need cable retention clips. See **Locking Outlets and Cords** (on page 20).*

► **To install and use a cable retention clip on the outlet:**

1. Locate two tiny holes at two sides of an outlet.

2. Install the cable retention clip by inserting two ends of the clip into the tiny holes.

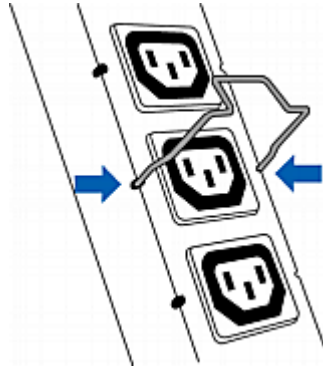

3. Plug the power cord into the outlet, and press the clip toward the power cord until it holds the cord firmly. The clip's central part holding the plug should face downwards toward the ground, like an inverted "U". This allows gravity to keep the clip in place.

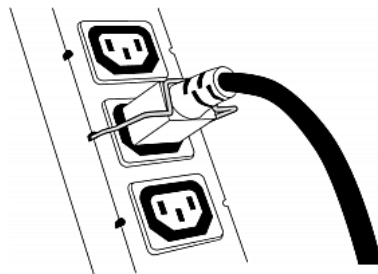

4. Repeat the same steps to install clips and power cords on the other outlets.

Locking Outlets and Cords

In addition to the cable retention clips, Raritan also provides other approaches to secure the connection of the power cords from your IT equipment to the Raritan PDUs, including:

- SecureLock™ outlets and cords
- Button-type locking outlets

Note that NOT all Raritan PDUs are implemented with any of the above locking outlets.

SecureLock™ Outlets and Cords

SecureLock™ is an innovative mechanism designed by Raritan, which securely holds C14 or C20 plugs that are plugged into Raritan PDUs in place. This method requires the following two components:

- Raritan PDU with SecureLock™ outlets, which have a latch slot inside either side of the outlet.
- SecureLock™ cords, which is a power cord with a locking latch on each side of its plug. The following diagram illustrates such a plug.

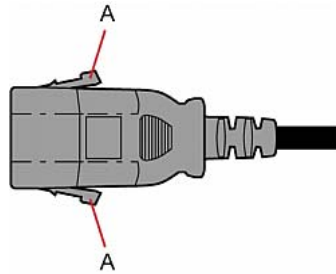

Item	Description
A	Latches on the SecureLock™ cord's plug

Only specific PDUs are implemented with the SecureLock™ mechanism. If your PDU does not have this design, do NOT use the SecureLock™ cords with it.

Tip: The SecureLock™ outlets can accept regular power cords for power distribution but the SecureLock™ mechanism does not take effect.

► To lock a power cord using the SecureLock™ mechanism:

1. Verify that the SecureLock™ cord you purchased meets your needs.
 - The cords' female socket matches the power socket type (C14 or C20) on your IT equipment.
 - The cord's male plug matches the outlet type (C13 or C19) on your PDU.
2. Connect the SecureLock™ cord between the IT equipment and your PDU.
 - Plug the female socket end of the cord into the power socket of the desired IT equipment.
 - Plug the male plug end of the cord into the appropriate SecureLock™ outlet on the PDU. Push the plug toward the outlet until you hear the click, which indicates the plug's latches are snapped into the latch slots of the outlet.

► **To remove a SecureLock™ power cord from the PDU:**

1. Press and hold down the two latches on the cord's plug as illustrated in the diagram below.

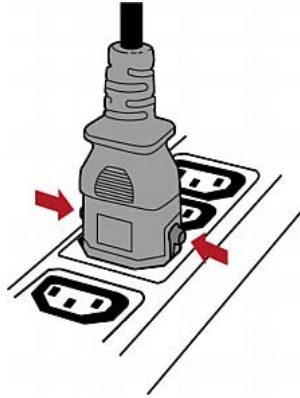

2. Unplug the cord now.

Button-Type Locking Outlets

A button-type locking outlet has a button on it. Such outlets do not require any special power cords to achieve the locking purpose. All you need to do is simply plug a regular power cord into the locking outlet and the outlet automatically locks the cord.

► **To remove a power cord from the locking outlet:**

1. Press and hold down the tiny button on the outlet. Depending on the outlet type, the button location differs.

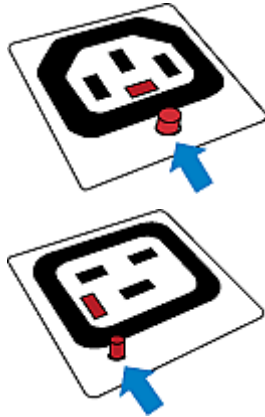

2. Unplug the power cord now.

Chapter 3 Initial Installation and Configuration

This chapter explains how to install a PX3 device and configure it for network connectivity.

In This Chapter

Connecting the PDU to a Power Source	23
Connecting the PX3 to Your Network.....	24
Configuring the PX3.....	27
Bulk Configuration Methods	37
Cascading Multiple PX3 Devices for Sharing Ethernet Connectivity.....	38
Power-Sharing Restrictions and Connection (for iX7™ Only)	47

Connecting the PDU to a Power Source

1. Verify that all circuit breakers on the PX3 device are set to ON. If not, turn them ON.

Or make sure that all fuses are inserted and seated properly. If there are any fuse covers, ensure that they are closed.

Note: Not all PX3 devices have overcurrent protection mechanisms.

2. Connect each PX3 to an appropriately rated branch circuit. See the label or nameplate affixed to your PX3 for appropriate input ratings or range of ratings.

Note: When a PX3 device powers up, it proceeds with the power-on self test and software loading for a few moments. At this time, the outlet LEDs cycle through different colors. Note that outlet LEDs are only available on some PDU models.

3. When the software has completed loading, the outlet LEDs show a steady color and the front panel display illuminates.

Connecting the PX3 to Your Network

To remotely administer the PX3, you must connect the PX3 to your local area network (LAN). PX3 can be connected to a wired or wireless network.

*Note: If your PX3 will work as a master device in the bridging mode, make a wired connection. See **Cascading the PX3 via USB** (on page 40).*

The Ethernet port must be enabled for this connection to work properly. Per default, the Ethernet port is enabled. See **Wired Network Settings** (on page 219).

► **To make a wired connection:**

1. Connect a standard network patch cable to the ETHERNET port on the PX3.
2. Connect the other end of the cable to your LAN.

For **PX3-iX7**, you can connect either Ethernet port to the LAN, but the "green" port labeled "ETH10/100/1000" is highly recommended because it supports 1000 Mbps. You can also connect both Ethernet ports to the LAN. See **Dual Ethernet Connection (for iX7[™] Only)** (on page 27).

Below illustrates the ETHERNET ports on Zero U models. Note that the port locations on your models may differ.

- PX3 models:

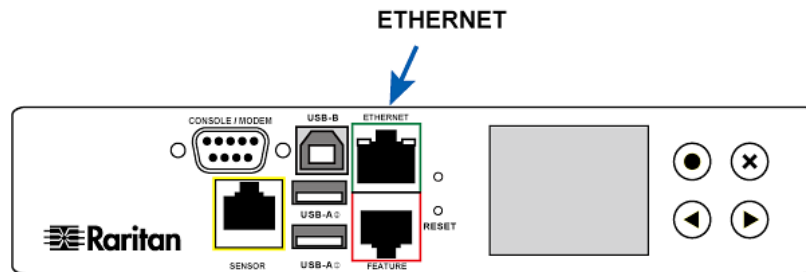

- PX3-iX7 models:

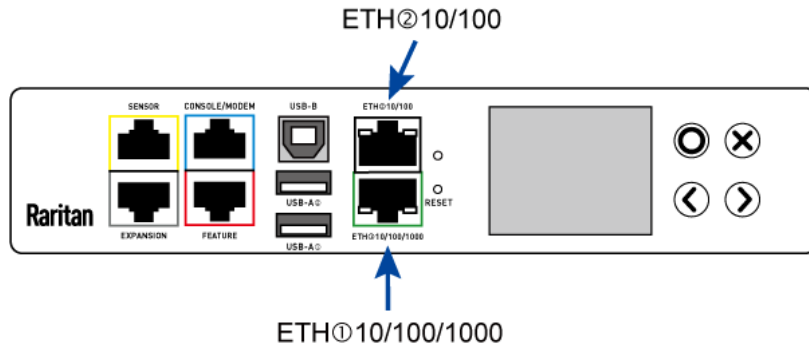

Warning: Accidentally plugging an RS-232 RJ-45 connector into the ETHERNET port can cause permanent damages to the Ethernet hardware.

► **To make a wireless connection:**

Do one of the following:

- Plug a supported USB wireless LAN adapter into the USB-A port on your PX3.
- Connect a USB hub to the USB-A port on the PX3. Then plug the supported USB wireless LAN adapter into the appropriate USB port on the hub.

See *USB Wireless LAN Adapters* (on page 25) for a list of supported wireless LAN adapters.

USB Wireless LAN Adapters

The PX3 supports the following USB Wi-Fi LAN adapters.

Wi-Fi LAN adapters	Supported 802.11 protocols
SparkLAN WUBR-508N	A/B/G/N
Proxim Orinoco 8494	A/B/G
Zyxel NWD271N	B/G
Edimax EW-7722UnD	A/B/G/N
TP-Link TL-WDN3200 v1	A/B/G/N
Raritan USB WIFI	A/B/G/N

Note: To use the Edimax EW-7722UnD or Raritan USB WIFI wireless LAN adapter to connect to an 802.11n wireless network, the handshake timeout setting must be changed to 500 or greater, or the wireless connection will fail.

Supported Wireless LAN Configuration

If wireless networking is preferred, ensure that the wireless LAN configuration of your PX3 matches the access point. The following is the wireless LAN configuration that the PX3 supports.

- Network type: 802.11 A/B/G/N
- Protocol: WPA2 (RSN)
- Key management: WPA-PSK, or WPA-EAP with PEAP and MSCHAPv2 authentication
- Encryption: CCMP (AES)

Important: Supported 802.11 network protocols vary according to the wireless LAN adapter being used with the PX3. See *USB Wireless LAN Adapters* (on page 25).

Dual Ethernet Connection (for iX7™ Only)

An iX7™ PDU has two Ethernet (LAN) ports:

- ETH①10/100/1000 (marked in *green*) supports up to 1000 Mbps. This is "ETH1".
- ETH②10/100 (marked in *white*) supports up to 100 Mbps. This is "ETH2".

For more information on the two ports, see **Connection Port Functions** (on page 89).

You can connect both ports to *different* subnets (networks) and therefore obtain two IP addresses for wired networking. It is strongly recommended that you DO NOT connect both ports to the same subnet to avoid potential issues. Contact your IT department if you are not sure whether the two Ethernet ports are connecting to the same or different subnets.

*Exception: A USB-cascading chain must connect to "only one" network. Do NOT connect both Ethernet ports of an iX7™ master or slave PDU to the LAN. See **Cascading Multiple PX3 Devices for Sharing Ethernet Connectivity** (on page 38).*

▶ **Check list when connecting both ports to the networks:**

- Both Ethernet interfaces are connecting to different subnets.
- Both Ethernet interfaces have been enabled. By default both are enabled. See **Device Info** (on page 111) and **Ethernet Interface Settings** (on page 221).
- Both Ethernet interfaces are configured with proper IPv4 and/or IPv6 settings. See **Wired Network Settings** (on page 219).
 - It is NOT required that the two Ethernet interfaces share similar network settings. For example, you can enable IPv4 settings in one interface but enable IPv6 settings in the other, or apply static IP to one but DHCP IP to the other.
- The cascading mode is disabled. By default it is disabled. See **Setting the Cascading Mode** (on page 231).

Configuring the PX3

You can initially configure the PX3 by connecting it to a computer, or to a TCP/IP network that supports DHCP.

▶ **Configuration over a DHCP-enabled network:**

1. Connect the PX3 to a DHCP IPv4 network. See **Connecting the PX3 to Your Network** (on page 24).

2. Retrieve the DHCP-assigned IPv4 address. Use the front panel LCD display to retrieve it. See **Device Info** (on page 111).
3. Launch a web browser to configure the PX3. See **Login** (on page 127).

► **Configuration using a connected computer:**

1. Connect the PX3 to a computer. See **Connecting the PX3 to a Computer** (on page 28).
2. Use the connected computer to configure the PX3 via the command line or web interface.
 - Command line interface: See **Initial Network Configuration via CLI** (on page 32).
 - Web interface: Launch the web browser on the computer, and type the link-local IP address or *pdu.local* to access the PX3. See **Login** (on page 127).

For link-local IP address retrieval, see **Device Info** (on page 111).

*Tip: To configure a number of PX3 devices quickly, see **Bulk Configuration Methods** (on page 37).*

Connecting the PX3 to a Computer

The PX3 can be connected to a computer for configuration via one of the following ports.

- USB-B port (male)
- ETHERNET port (female)
- RS-232 serial port (model dependent -- male DB9 or female RJ-45 connector)

Note that the port locations on your models may differ.

- PX3 models:

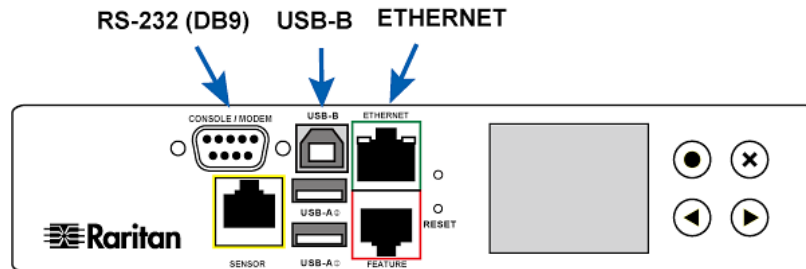

- PX3-iX7 models:

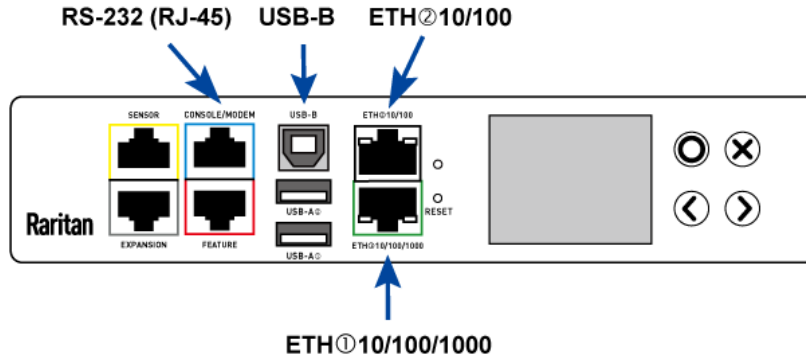

To use the command line interface (CLI) for configuration, establish an RS-232 or USB connection.

To use a web browser for configuration, make a network connection to the computer. The PX3 is automatically configured with the following link-local addressing in any network without DHCP available:

- `https://169.254.x.x` (where x is a number)
- `https://pdu.local`

See *APIPA and Link-Local Addressing* (on page 3).

Establish one of the following connections to a computer.

▶ **Serial connection for "DB9" RS-232 connector on PX3:**

1. Connect one end of the null-modem DB9 cable to the male "DB9" RS-232 port labeled CONSOLE / MODEM on the PX3.
2. Connect the other end to your computer's RS-232 port (COM).
3. Perform *Initial Network Configuration via CLI* (on page 32).

▶ **Serial connection for "RJ-45" RS-232 connector on PX3-iX7:**

The iX7™ PDU's serial connection procedure is the same as above except that a third party RJ-45 to "DB9 female" adapter/cable is required, such as the blue Cisco adapter cable. This is because the CONSOLE / MODEM port on iX7™ is a female RJ-45 connector.

See *RJ45-to-DB9 Cable Requirements for Computer Connections (for iX7™ Only)* (on page 30).

▶ **USB connection:**

1. A USB-to-serial driver is required in Windows®. Install this driver before connecting the USB cable. See *Installing the USB-to-Serial Driver (Optional)* (on page 31).

2. Connect a USB cable between the PX3 device's USB-B port and a computer's USB-A port.
3. Perform **Initial Network Configuration via CLI** (on page 32).

Note: Not all serial-to-USB converters work properly with the PX3 so Raritan does not introduce the use of such converters.

► **Direct network connection:**

The Ethernet port must be enabled for this connection to work properly. Per default, the Ethernet port is enabled.

1. Connect one end of a standard network patch cable to the ETHERNET port of the PX3.
 - For iX7™, either Ethernet port is fine.
2. Connect the other end to a computer's Ethernet port.
3. On the connected computer, launch a web browser to access the PX3, using either link-local addressing: *pdu.local* or *169.254.x.x*. See **Login** (on page 127).

RJ45-to-DB9 Cable Requirements for Computer Connections (for iX7™ Only)

An RJ45-to-DB9 adapter/cable is required for connecting the iX7™ to a computer, if the use of a USB cable is not intended.

A third party RJ45-to-DB9 adapter/cable needs to meet the following requirements.

- RJ-45 to "DB9 female"
- RX/TX and according control pins are CROSSED

The widespread blue Cisco RJ-45 to DB9 adapter cable is highly recommended, which has the following pin assignments:

DB9 pin signal	DB9 pin No.	RJ-45 pin No.	RJ-45 pin signal
CTS	8	1	RTS
DSR	6	2	DTR
RxD	2	3	TxD
GND	5	4	GND
GND	5	5	GND
TxD	3	6	RxD
DTR	4	7	DSR
RTS	7	8	CTS
DCD	1 (Not connected)	N/A	

DB9 pin signal	DB9 pin No.	RJ-45 pin No.	RJ-45 pin signal
RI	9 (Not connected)		

*Note: The blue Cisco RJ-45 to DB9 adapter cable CANNOT be used for connecting any modem. See **RJ45-to-DB9 Cable Requirements for Modem Connections (for iX7™ Only)** (on page 670).*

Installing the USB-to-Serial Driver (Optional)

The PX3 can emulate a USB-to-serial converter over a USB connection. A USB-to-serial driver named "Dominion PX2 Serial Console" is required for Microsoft® Windows® operating systems.

Download the Windows driver for USB serial console from the Raritan website's **Support page** (<http://www.raritan.com/support/>). The downloaded driver's name is *dominion-serial-setup-<n>.exe*, where <n> represents the file's version number.

There are two ways to install this driver: automatic and manual installation. Automatic driver installation is highly recommended.

► Automatic driver installation in Windows®:

1. Make sure the PX3 is NOT connected to the computer via a USB cable.
2. Run *dominion-serial-setup-<n>.exe* on the computer and follow online instructions to install the driver.

Note: If any Windows security warning appears, accept it to continue the installation.

3. Connect the PX3 to the computer via a USB cable. The driver is automatically installed.

► Manual driver installation in Windows®:

1. Make sure the PX3 has been connected to the computer via a USB cable.
2. The computer detects the new device and the "Found New Hardware Wizard" dialog appears.
 - If this dialog does not appear, choose Control Panel > System > Hardware > Device Manager, right-click the *Dominion PX2 Serial Console*, and choose Update Driver.
3. Select the option of driver installation from a specific location, and then specify the location where both *dominion-serial.inf* and *dominion-serial.cat* are stored.

Note: If any Windows security warning appears, accept it to continue the installation.

4. Wait until the installation is complete.

Note: If the PX3 enters the disaster recovery mode when the USB serial driver is not installed yet, it may be shown as a 'GPS camera' in the Device Manager on the computer connected to it.

► **In Linux:**

No additional drivers are required, but you must provide the name of the tty device, which can be found in the output of the "dmesg" after connecting the PX3 to the computer. Usually the tty device is "/dev/ttyACM#" or "/dev/ttyUSB#," where # is an integer number.

For example, if you are using the kermit terminal program, and the tty device is "/dev/ttyACM0," perform the following commands:

```
> set line /dev/ttyACM0  
> Connect
```

Initial Network Configuration via CLI

After the PX3 is connected to your network, you must provide it with an IP address and some additional networking information.

This section describes the initial network configuration via a serial RS-232 or USB connection. To configure the network settings using the web interface, see **Configuring Network Settings** (on page 218).

► **To configure the PX3 device:**

1. On the computer connected to the PX3, open a communications program such as HyperTerminal or PuTTY.
2. Select the appropriate COM port, and set the following port settings:
 - Bits per second = 115200 (115.2Kbps)
 - Data bits = 8
 - Stop bits = 1
 - Parity = None
 - Flow control = None

Tip: For a USB connection, you can determine the COM port by choosing Control Panel > System > Hardware > Device Manager, and locating the "Dominion PX2 Serial Console" under the Ports group.

3. In the communications program, press Enter to send a carriage return to the PX3.

4. The PX3 prompts you to log in. Both user name and password are case sensitive.
 - a. Username: admin
 - b. Password: raritan (or a new password if you have changed it).
5. If prompted to change the default password, change or ignore it.
 - To change it, follow onscreen instructions to type your new password.
 - To ignore it, simply press Enter.
6. The # prompt appears.
7. Type `config` and press Enter.
8. To configure network settings, type appropriate commands and press Enter. Refer to the following commands list. CLI commands are case sensitive.
9. After finishing the network settings, type `apply` to save changes. To abort, type `cancel`.

► **Commands for wired networking:**

The `<ipvX>` variable in the following commands is either `ipv4` or `ipv6`, depending on the type of IP protocol you are configuring.

For PX2 and PX3, replace the variable `<ETH>` with the word "ethernet". For PX3-iX7, replace the variable `<ETH>` with either 'ETH1' or 'ETH2', depending on which Ethernet port you are configuring.

• **General IP settings:**

To set or enable	Use this command
IPv4 or IPv6 protocol	<pre>network <ipvX> interface <ETH> enabled <option></pre> <p><code><option> = true, or false</code></p>
IPv4 configuration method	<pre>network ipv4 interface <ETH> configMethod <mode></pre> <p><code><mode> = dhcp (default) or static</code></p>
IPv6 configuration method	<pre>network ipv6 interface <ETH> configMethod <mode></pre> <p><code><mode> = automatic (default) or static</code></p>
Preferred host name (optional)	<pre>network <ipvX> interface <ETH> preferredHostName <name></pre> <p><code><name> = preferred host name</code></p>

To set or enable	Use this command
IP address returned by the DNS server	<pre>network dns resolverPreference <resolver></pre> <p><resolver> = <i>preferV4</i> or <i>preferV6</i></p>

- **Static IP configuration:**

To set	Use this command
Static IPv4 or IPv6 address	<pre>network <ipvX> interface <ETH> address <ip address></pre> <p><ip address> = static IP address, with a syntax similar to the example below.</p> <ul style="list-style-type: none"> ▪ Example: <i>192.168.7.9/24</i>
Static IPv4 or IPv6 gateway	<pre>network <ipvX> gateway <ip address></pre> <p><ip address> = gateway's IP address</p>
IPv4 or IPv6 primary DNS server	<pre>network dns firstServer <ip address></pre> <p><ip address> = DNS server's IP address</p>
IPv4 or IPv6 secondary DNS server	<pre>network dns secondServer <ip address></pre> <p><ip address> = DNS server's IP address</p>
IPv4 or IPv6 third DNS server	<pre>network dns thirdServer <ip address></pre> <p><ip address> = DNS server's IP address</p>

► **Commands for wireless networking:**

• **General wireless settings:**

To set or enable	Use this command
Wireless interface	network wireless enabled <option> <option> = <i>true</i> , or <i>false</i>
SSID	network wireless SSID <ssid> <ssid> = SSID string
BSSID	network wireless BSSID <bssid> <bssid> = AP MAC address or <i>none</i>
802.11n protocol	network wireless enableHT <option> <option> = <i>true</i> , or <i>false</i>
Authentication method	network wireless authMethod <method> <method> = <i>psk</i> or <i>eap</i>
PSK	network wireless PSK <psk> <psk> = PSK string
EAP outer authentication	network wireless eapOuterAuthentication <outer_auth> <outer_auth> = <i>PEAP</i>
EAP inner authentication	network wireless eapInnerAuthentication <inner_auth> <inner_auth> = <i>MSCHAPv2</i>
EAP identity	network wireless eapIdentity <identity> <identity> = your user name for EAP authentication

To set or enable	Use this command
EAP password	<pre>network wireless eapPassword</pre> <p>When prompted to enter the password for EAP authentication, type the password.</p>
EAP CA certificate	<pre>network wireless eapCACertificate</pre> <p>When prompted to enter the CA certificate, open the certificate with a text editor, copy and paste the content into the communications program.</p>

The content to be copied from the CA certificate does NOT include the first line containing "BEGIN CERTIFICATE" and the final line containing "END CERTIFICATE." If a certificate is installed, configure the following:

Whether to	Use this command
Verify the certificate	<pre>network wireless enableCertVerification <option1></pre> <p><i><option1> = true or false</i></p>
Accept an expired or not valid certificate	<pre>network wireless allowOffTimeRangeCerts <option2></pre> <p><i><option2> = true or false</i></p>
Make the connection successful by ignoring the "incorrect" system time	<pre>network wireless allowConnectionWithIncorrectClock <option3></pre> <p><i><option3> = true or false</i></p>

- **Wireless IPv4 / IPv6 settings:**

Commands for wireless IP settings are identical to those for wired networking. Just replace the variable <ETH> with the word 'wireless'. The following illustrates a few examples.

To set or enable	Use this command
IPv4 configuration method	network ipv4 interface WIRELESS configMethod <mode> <mode> = <i>dhcp</i> (default) or <i>static</i>
IPv6 configuration method	network ipv6 interface WIRELESS configMethod <mode> <mode> = <i>automatic</i> (default) or <i>static</i>

- ▶ **To verify network settings:**

After exiting the above configuration mode and the # prompt re-appears, type this command to verify all network settings.

```
show network
```

The IP address configured may take seconds to take effect.

Bulk Configuration Methods

If you have to set up multiple PX3 devices, you can use one of the following configuration methods to save your time.

- ▶ **Use a bulk configuration file:**

- Requirement: All PX3 devices to configure are of the same model and firmware.
- Procedure: First finish configuring one PX3. Then save the bulk configuration file from it and copy this file to all of the other PX3 devices.

See ***Bulk Configuration*** (on page 344).

- ▶ **Use a TFTP server:**

- Requirement: DHCP is enabled in your network and a TFTP server is available.
- Procedure: Prepare special configuration files, which must include *fwupdate.cfg*, and copy them to the root directory of the TFTP server. Re-boot all PX3 after connecting them to the network.

See ***Bulk Configuration or Firmware Upgrade via DHCP/TFTP*** (on page 562).

► **Use a USB flash drive:**

- Requirement: A FAT32- or superfloppy-formatted USB flash drive containing special configuration files is required.
- Procedure: Plug this USB drive into the PX3. When a happy smiley is shown on the front panel display, press and hold one of the control buttons on the front panel until the display turns blank.

See *Configuration or Firmware Upgrade with a USB Drive* (on page 548).

Cascading Multiple PX3 Devices for Sharing Ethernet Connectivity

You can have multiple PX3 devices share one Ethernet connection by cascading them via one of the interfaces below:

- USB interface -- for cascading multiple PX3 or multiple iX7™ PDUs
- Ethernet interface -- for cascading multiple iX7™ PDUs

Warning: Firmware version 3.3.10 is NOT compatible with old firmware versions in terms of the USB-cascading feature so all devices in a chain must be running version 3.3.10 or later. Otherwise, a networking issue occurs. When upgrading an existing USB-cascading chain from any version prior to 3.3.10, the upgrade must start from the last slave device, then the second to last, the third to last, and so on until the master device. Any upgrade without following this sequence results in the networking failure of some cascaded devices.

The first one in the cascading chain is the master device and all the other are slave devices. Only the master device is physically connected to the LAN -- wired or wireless.

Each device in the chain is accessible over the network, with the bridging or port-forwarding cascading mode activated on the master device. See ***Setting the Cascading Mode*** (on page 231).

- Bridging: Each device in the cascading chain is accessed with a different IP address.
- Port Forwarding: Each device in the cascading chain is accessed with the same IP address but with a different port number assigned.

▶ **Cascading restrictions:**

- In the bridging mode, the master device can have "only one" connection to the network. If the master device is a PX3-iX7 PDU with two Ethernet ports, DO NOT connect both ports to the network(s) in this mode.

Note: The port forwarding mode does NOT have such a restriction. In the port forwarding mode, you can enable both wired and wireless networking, or enable both Ethernet ports.

- Do NOT connect slave devices to the LAN via a standard network patch cable or a USB wireless LAN adapter.
- An Ethernet-cascaded device must have its Ethernet interface enabled for the networking to work properly. By default the Ethernet interface is enabled.

▶ **USB-cascading tip:**

The "USB-cascading" configuration can be a combination of diverse Raritan products that support the USB-cascading feature, including PX2, PX3, PX3-iX7, transfer switch, BCM and EMX.

▶ **Troubleshooting:**

When a networking issue occurs, check the cascading connection and/or software settings of all devices in the chain. See ***Cascading Troubleshooting*** (on page 688).

Cascading the PX3 via USB

Any certified USB 2.0 cable up to 16 feet (5 meters) long can be used.

Decide the cascading mode first before establishing the chain. All cascading modes support a maximum of 16 devices in a chain.

For more information on the USB-cascading configuration, see the *Cascading Guide*, which is available from Raritan website's **Support page** (<http://www.raritan.com/support/>).

The following diagram illustrates PX3 PDUs cascaded via either USB.

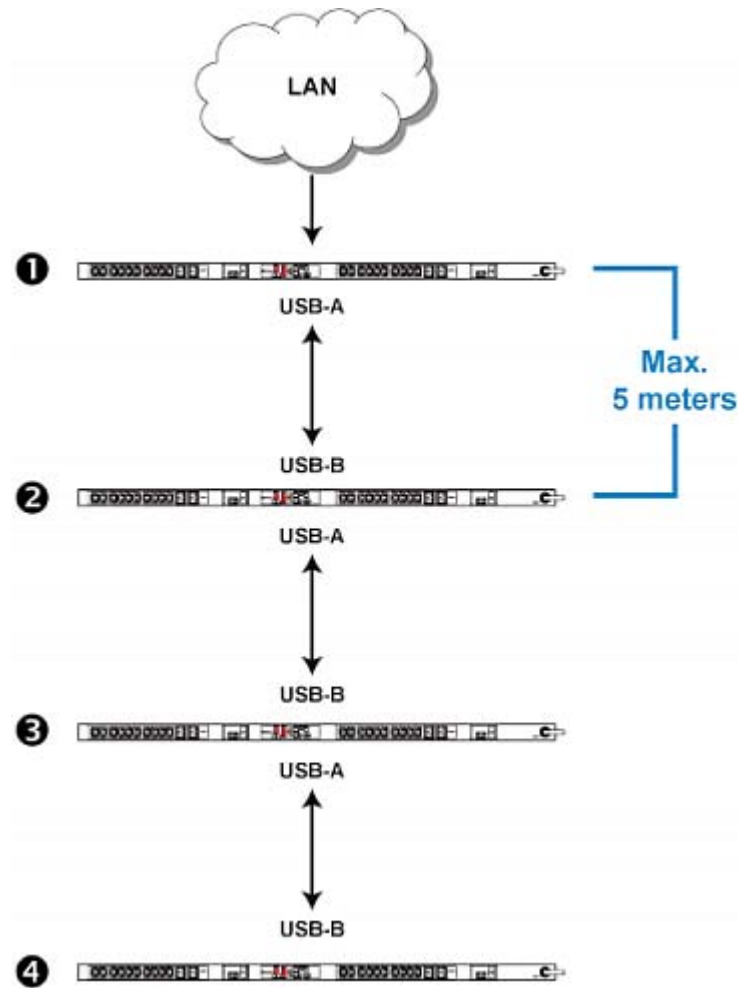

Number	Device role
1	Master device
2	Slave 1

Number	Device role
3	Slave 2
4	Slave 3

► **To cascade PX3 devices via USB:**

1. Make sure all Raritan devices to be cascaded are running firmware version 3.3.10 or later.
2. Select one as the master device.
 - When the port forwarding mode over wireless LAN is intended, the master device must be a Raritan product with two USB-A ports, such as PX3, EMX2-888, PX3TS or BCM2.
3. Log in to all devices one by one and select the same cascading mode. See ***Setting the Cascading Mode*** (on page 231).
 - **Bridging mode:**
Set the cascading mode of all devices to Bridging.
 - **Port Forwarding mode:**
Set the cascading mode of all devices to Port Forwarding. Make sure the cascading role and downstream interface are also set correctly.
4. Connect the master device to the LAN, using a method below.
 - **Bridging mode:** Use a standard network patch cable (CAT5e or higher).
Port Forwarding mode: Use a standard network patch cable or a Raritan USB WIFI wireless LAN adapter. For information on the Raritan USB WIFI adapter, see ***USB Wireless LAN Adapters*** (on page 25).
5. Connect the USB-A port of the master device to the USB-B port of an additional PX3 via a USB cable. This additional device is Slave 1.
6. Connect Slave 1's USB-A port to the USB-B port of an additional PX3 via another USB cable. The second additional device is Slave 2.
7. Repeat the same step to connect more slave devices.
8. Configure or change the network settings of the master and/or slave devices as needed.
 - **Bridging:** Each cascaded device has its own network settings. For example, some devices can have DHCP-assigned IP and the others can have static IP addresses.
 - **Port forwarding:** Only the master device's network settings should be configured.

Extended Cascading with PX3-iX7 Models

Only PX3-iX7 PDUs support cascading via either Ethernet or USB ports. These PDUs support cascading via Ethernet ports because they have two Ethernet ports. Other Raritan products do NOT support Ethernet cascading.

There is no restriction of using which Ethernet port of PX3-iX7 for network connection and which port for cascading, but the 'green' ETH1 port (ETH⑩10/100/1000) is highly recommended for network connection because it supports up to 1000 Mbps.

An Ethernet-cascaded device must have its Ethernet interface enabled for the networking to work properly. By default the Ethernet interface is enabled.

The distance between two Ethernet-cascaded PDUs can be up to 100 meters, but the distance between two USB-cascaded PDUs supports up to 5 meters only.

Decide the cascading mode first before establishing the chain. All cascading modes support a maximum of 16 devices in a chain.

When establishing a cascading chain in the port forwarding mode, make sure you follow the guidelines described in the section titled *Unsupported Cascading Connections for Port Forwarding* (on page 45).

Special application: You can "loop" a cascading chain to create network communication redundancy (bridging mode only), but only when your network supports R/STP protocol. Make sure that your network has R/STP enabled if using a cascade loop (bridging mode) or else network loops may occur.

If wanted, you can mix Ethernet and USB cascading in a PX3-iX7 cascading chain. The following diagram illustrates such a chain.

For instructions on USB cascading, see *Cascading the PX3 via USB* (on page 40).

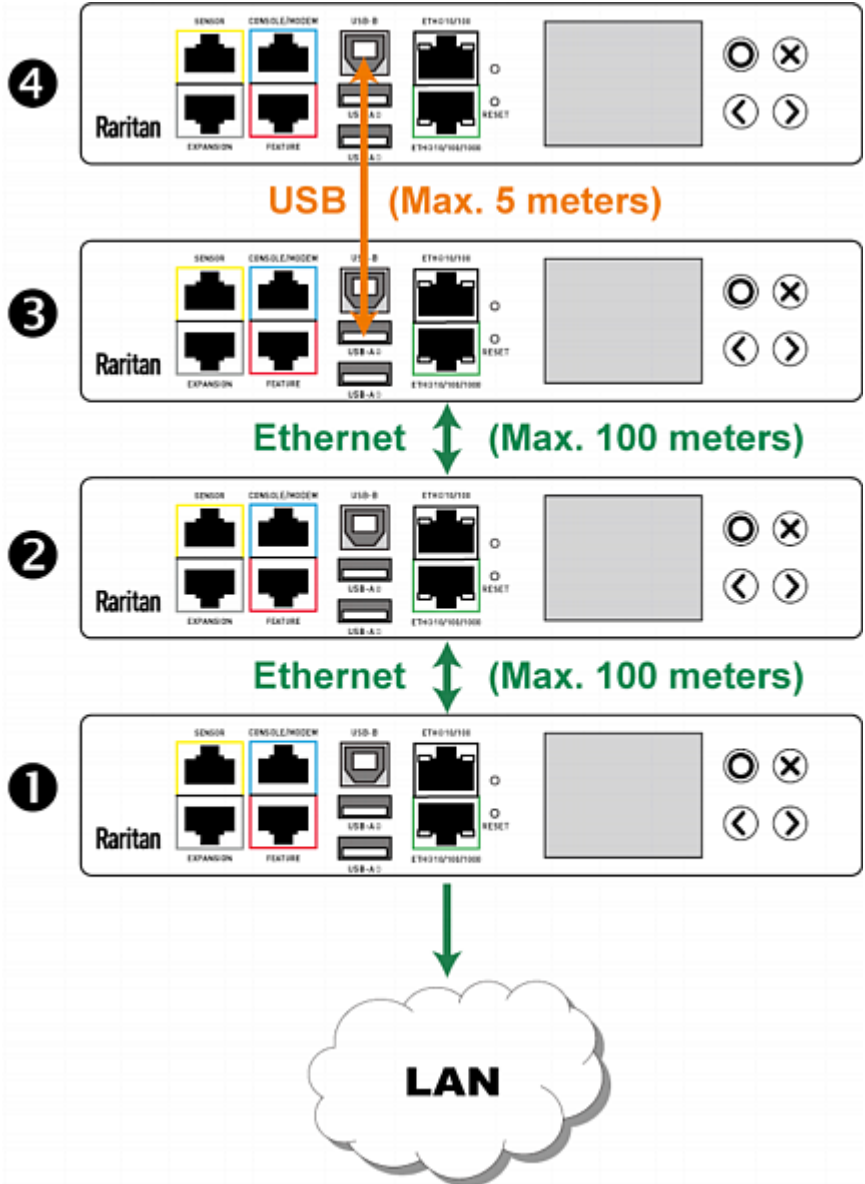

Number	Device role
3	Slave 2
4	Slave 3

► **To cascade iX7™ PDUs via Ethernet ports:**

1. Make sure all Raritan devices to be cascaded are running firmware version 3.3.10 or later.
2. Choose one iX7™ PDU as the master device.
3. Log in to all devices one by one and select the same cascading mode. See ***Setting the Cascading Mode*** (on page 231).
 - **Bridging mode:**
Set the cascading mode of all devices to Bridging.
 - **Port Forwarding mode:**
Set the cascading mode of all devices to Port Forwarding. Make sure the cascading role and downstream interface are also set correctly.
4. Connect the master device to the LAN, using a method below.
 - **Bridging mode:** Use a standard network patch cable (CAT5e or higher).
Port Forwarding mode: Use a standard network patch cable or a Raritan USB WIFI wireless LAN adapter. For information on the Raritan USB WIFI adapter, see ***USB Wireless LAN Adapters*** (on page 25).
5. Connect the available Ethernet port of the master device to either Ethernet port of another iX7™ via a standard network patch cable. This additional iX7™ device is Slave 1.
6. Connect Slave 1's available Ethernet port to either Ethernet port of another iX7™ via a standard network patch cable. The second additional device is Slave 2.
7. Repeat the same step to connect more iX7™ devices.
8. Configure or change the network settings of the master and/or slave devices as needed.
 - **Bridging:** Each cascaded device has its own network settings. For example, some devices can have DHCP-assigned IP and the others can have static IP addresses.
 - **Port forwarding:** Only the master device's network settings should be configured.

Unsupported Cascading Connections for Port Forwarding

The following guidelines must be obeyed for establishing a cascading chain in the **port forwarding** mode.

- Each cascaded device, except for the master device, must have only one upstream device.
- Each cascaded device, except for the last slave device, must have only one downstream device.
- Use only one cable to cascade two devices. That is, NO simultaneous connection of USB and Ethernet cables between two cascaded devices.

The following diagrams illustrate cascading connections that are NOT supported.

▶ **UNSUPPORTED connections:**

- One cascaded device has two upstream devices via Ethernet cables.

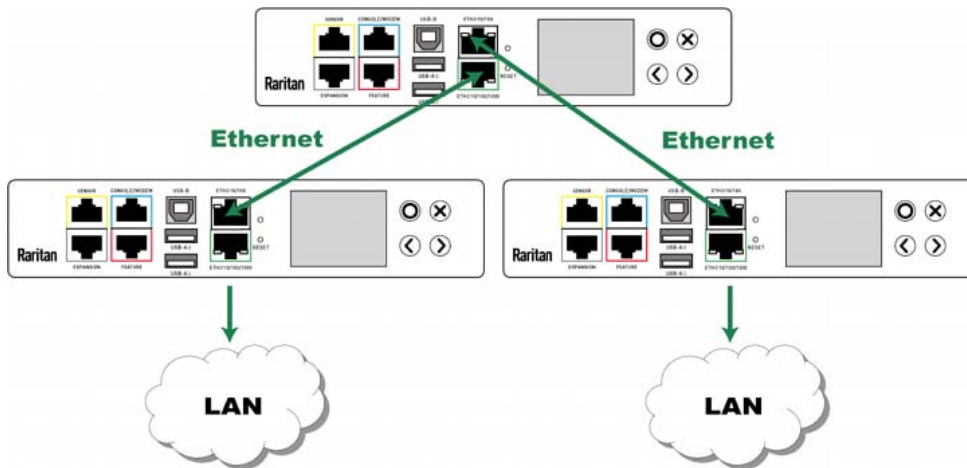

- One cascaded device has two upstream devices via Ethernet and USB cables.

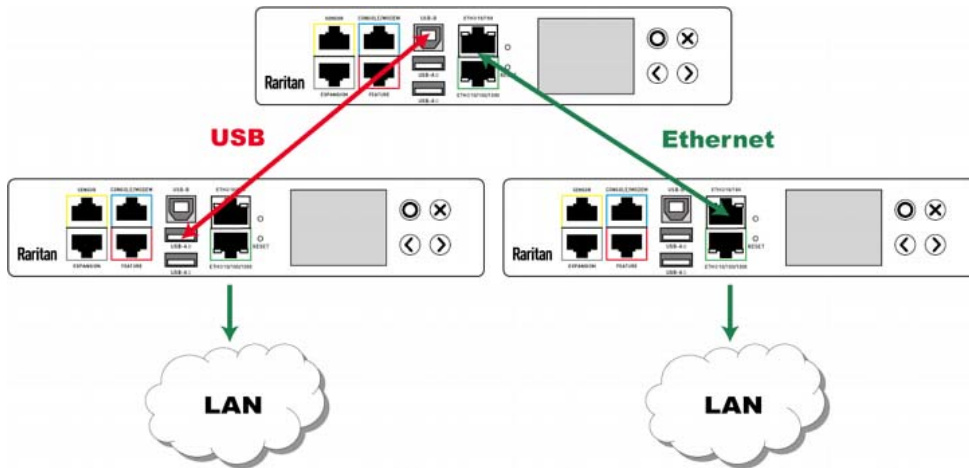

- One cascaded device has two downstream devices.

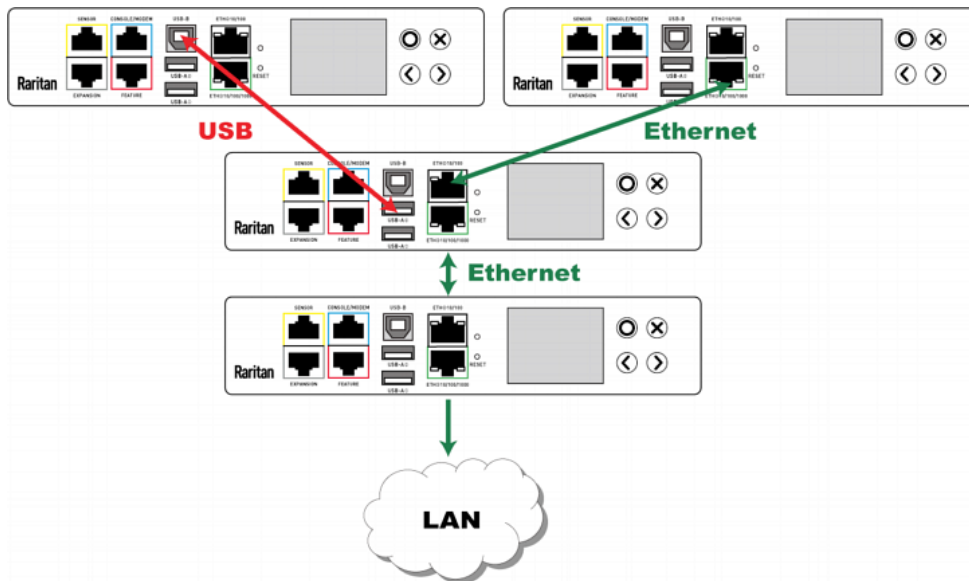

- One device is connected to another device via two cascading cables - USB and Ethernet cables.

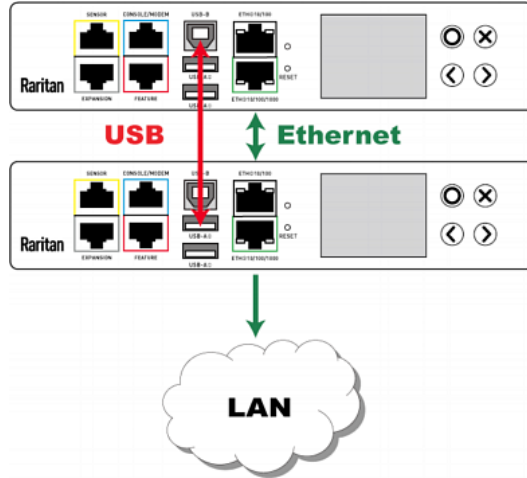

Power-Sharing Restrictions and Connection (for iX7™ Only)

Two iX7™ PDUs can share power supply to their controllers via EXPANSION ports, so that when either iX7™ controller fails to receive DC 12V power from its inlet, it continues to receive backup power from another iX7™ PDU which functions properly and therefore remains to be accessible to users.

For documentation purpose, the term "power-sharing mode" is used to describe the status when the 12V power supply from the inlet to an iX7™ controller fails and that iX7™ controller is receiving power from another iX7™ PDU.

Before making a power-sharing connection, first read *Power-Sharing Configurations and Restrictions* (on page 50), and remove unsupported equipment from BOTH iX7™ PDUs.

When a PDU enters the power-sharing mode, some data/operations remain to be available while other data/operations are no longer available.

► **Unavailable data or operations on the PDU that enters the power-sharing mode:**

- All outlets lose power, and enter the "disabled" state.
 - No outlet switching can be performed if the iX7™ is an outlet-switching capable PDU.

- All internal sensors become "unavailable", including sensors of inlets, outlets, and OCPs.

Exception: Only active energy data remains available.

- Communications with relay/meter boards are lost. Therefore, firmware upgrade may fail due to this reason.

▶ **Available data or operations on the PDU that enters the power-sharing mode:**

- Change software settings, such as customizing names, modifying network settings, configuring thresholds, and so on.

Note: Outlet switching is not available because all outlets lose power.

- Monitor the status of connected Raritan environmental sensor packages, or configure/control their settings.
- Operate the front panel display.

Exception: Operation of the front panel display is NOT available on a PX3 with residual current monitoring because it assumes that there is an RCM alarm when losing power supply from the inlet.

▶ **Events that occur when entering the power-sharing mode:**

- The 12V power supply sensor enters the fault state. See **+12V Power Supply Sensor (for iX7™ Only)** (on page 154).

*Tip: You can set an event rule for sending a notification when this sensor enters the fault state. See **Event Rules and Actions** (on page 272).*

- The above event is logged in the internal event log. See **Default Log Messages** (on page 278).

▶ **To find whether an iX7™ has entered the power-sharing mode:**

- Check the state of its +12V power supply sensor.

Tip: For SNMP, the sensor type for this +12V power supply is `i1smplsStatus (46)`.

Making a Power-Sharing Connection

Make sure **BOTH** iX7™ PDUs comply with the configuration limitations before establishing a power-sharing connection. See *Power-Sharing Configurations and Restrictions* (on page 50).

The supported maximum power-sharing distance is 2 meters.

► **Make a power-sharing connection:**

1. Get a standard network patch cable (Cat5e/6), which can be up to 2 meters long.
 - Do NOT use a crossover cable.
2. Connect one end to an iX7™ PDU's EXPANSION port, and the other end to another one's EXPANSION port.
 - Note that the EXPANSION port location on your iX7™ may differ from the following images.

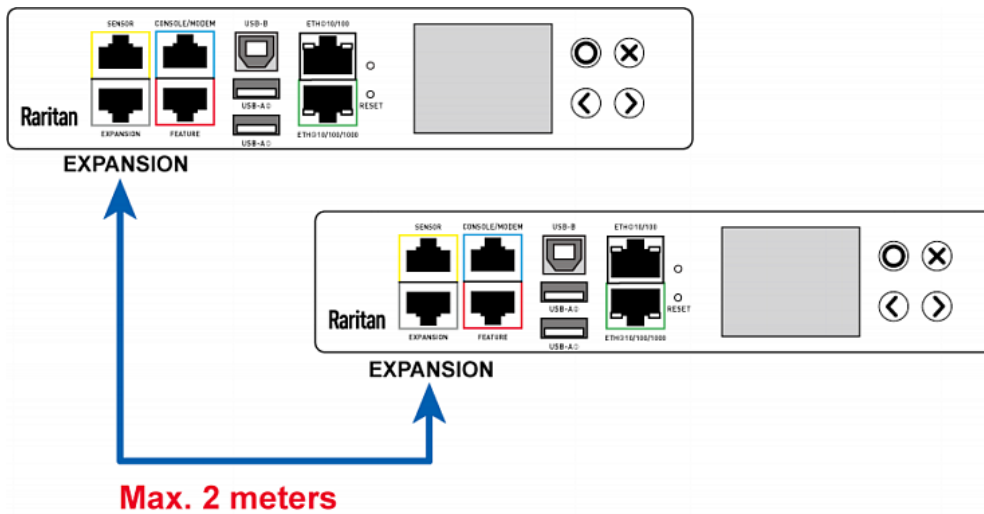

Power-Sharing Configurations and Restrictions

When either iX7™ PDU enters the power-sharing mode, BOTH PDUs involved in the power-sharing connection support "less" external equipment than usual. It is strongly recommended to remove specific equipment from both iX7™ PDUs when making a power-sharing connection.

▶ **Configuration limitations on "both" PDUs:**

- No USB wireless LAN adapter is connected. That is, you have to connect both PDUs to a "wired" network if LAN access is wanted.
- No asset management strips are connected.
- The maximum number of DX environmental packages or door handles that can be connected decreases. For details, see *Supported Sensor Configurations for Power Sharing* (on page 51).
- When either PDU enters the power-sharing mode, you must NOT physically remove or add environmental sensor packages to BOTH PDUs.

Supported Sensor Configurations for Power Sharing

All information and restrictions described in this section apply to BOTH PDUs involved in the power-sharing configuration, unless otherwise specified.

There are no limitations for connecting Raritan's DPX or DPX2 environmental sensor packages to an iX7™ PDU in the power-sharing mode. See *DPX Sensor Packages* (on page 54) or *DPX2 Sensor Packages* (on page 59).

The maximum number of supported DPX3 environmental sensor packages remains unchanged -- that is, 12 DPX3 packages. See *DPX3 Sensor Packages* (on page 61).

The maximum number of supported DX environmental sensor packages also remains unchanged as long as the DPX3-ENVHUB4 sensor hub is not used -- that is, 12 DX sensor packages. See *DX Sensor Packages* (on page 63).

However, there are DX restrictions when DPX3-ENVHUB4 is used, and there are also door handles-related restrictions.

▶ **DX sensor restrictions when connected via DPX3-ENVHUB4:**

- A maximum of one DPX3-ENVHUB4 and a maximum of 10 DX sensor packages are supported.

▶ **Restrictions of connecting door handles via DX-PD2C5:**

- A maximum of 4 handles connected to a maximum of two DX-PD2C5 packages are supported.
- All of the 4 handles must be controlled by the same PDU to ensure that only one handle is in the unlocked state at a time. That is, the door handles are connected to only one PDU in the power-sharing connection, NOT both.
- When more than one DX-PD2C5 are required, they must be cascaded via standard network patch cables, instead of using a sensor hub.

▶ **Other sensor restrictions when door handles are present:**

Make sure the connection of door handles complies with the above restrictions.

The following restrictions do NOT apply to the other PDU that does not have the door handles connected.

- When there are 4 or 3 handles connected to the PDU (via a maximum of two DX-PD2C5 packages), "only one" additional DPX/DPX2/DPX3 environmental sensor package can be connected to that PDU. Raritan's sensor hubs must NOT be used.
 - When there are 2 handles connected to the PDU (via only one DX-PD2C5), up to 10 sensor packages of DPX/DPX2/DPX3 or up to 2 additional DX sensor packages can be additionally connected. Raritan's sensor hubs must NOT be used.
 - When there is only 1 handle connected, up to 12 sensor packages of DPX/DPX2/DPX3 or up to 3 DX sensor packages can be additionally connected. Raritan's sensor hubs must NOT be used.
- ▶ **NO physical changes made to the number of connected sensor packages:**
- When either PDU enters the power-sharing mode, you must NOT physically remove or add environmental sensor packages to BOTH PDUs.

Warning: The in-rush current of a newly added sensor package may cause both PDUs to reboot.

For information on Raritan's sensor packages or hubs, see *Connecting Environmental Sensor Packages* (on page 53).

Chapter 4 Connecting External Equipment (Optional)

More features are available if you connect Raritan's or third-party external equipment to your PX3.

In This Chapter

Connecting Environmental Sensor Packages	53
Connecting Asset Management Strips.....	72
Connecting a Logitech Webcam.....	81
Connecting a GSM Modem	82
Connecting an Analog Modem	83
Connecting an External Beeper	83
Connecting a Schroff LHX/SHX Heat Exchanger	84

Connecting Environmental Sensor Packages

The PX3 supports all types of Raritan environmental sensor packages, including DPX, DPX2, DPX3 and DX sensor packages. For detailed information on each sensor package, refer to the Environmental Sensors Guide or Online Help on the Raritan website's *Support page* (<http://www.raritan.com/support/>).

An environmental sensor package may comprise sensors only or a combination of sensors and actuators.

The PX3 can manage a maximum of 32 sensors and/or actuators. The supported maximum cabling distance is 98 feet (30 m), except for DPX sensor packages.

For information on connecting different types of sensor packages, see:

- *DPX Sensor Packages* (on page 54)
- *DPX2 Sensor Packages* (on page 59)
- *DPX3 Sensor Packages* (on page 61)
- *DX Sensor Packages* (on page 63)

DPX Sensor Packages

Most DPX sensor packages come with a factory-installed sensor cable, whose sensor connector is RJ-12.

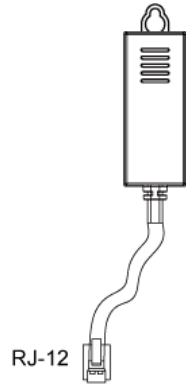

For the cabling length restrictions, see *Supported Maximum DPX Sensor Distances* (on page 58).

Warning: For proper operation, wait for 15-30 seconds between each connection operation or each disconnection operation of environmental sensor packages.

► **To directly connect a DPX with a factory-installed sensor cable:**

An RJ-12 to RJ-45 adapter is required to connect a DPX sensor package to the PX3.

- a. Connect the adapter's RJ-12 connector to the DPX sensor cable.
- b. Connect the adapter's RJ-45 connector to the RJ-45 SENSOR port of the PX3.

► **To directly connect a differential air pressure sensor:**

1. Connect a Raritan-provided phone cable to the IN port of a differential air pressure sensor.
2. Get an RJ-12 to RJ-45 adapter. Connect the adapter's RJ-12 connector to the other end of the phone cable.
3. Connect this adapter's RJ-45 connector to the RJ-45 SENSOR port on the PX3.

4. If intended, connect one DPX sensor package to the OUT port of the differential air pressure sensor. It can be any DPX sensor package, such as a DPX-T3H1.

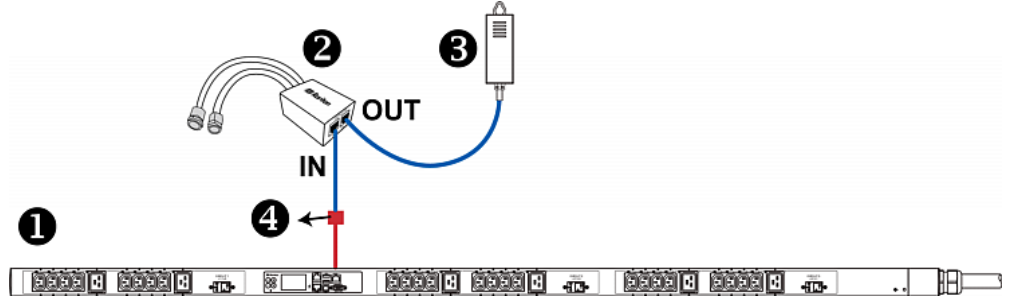

①	The PX3 device
②	Raritan differential air pressure sensors
③	One DPX sensor package (optional)
④	RJ-12 to RJ-45 adapter

Using an Optional DPX-ENVHUB4 Sensor Hub

Optionally, you can connect a Raritan *DPX-ENVHUB4* sensor hub to the PX3. This allows you to connect up to four DPX sensor packages to the PX3 via the hub.

This sensor hub supports DPX sensor packages only. Do NOT connect DPX2, DPX3 or DX sensor packages to it.

DPX-ENVHUB4 sensor hubs CANNOT be cascaded. You can connect only one hub to each SENSOR port on the PX3.

*Tip: The Raritan sensor hub that supports ALL types of Raritan environmental sensor packages is DPX3-ENVHUB4. See **Using an Optional DPX3-ENVHUB4 Sensor Hub** (on page 66).*

► To connect DPX sensor packages via the DPX-ENVHUB4 hub:

1. Connect the DPX-ENVHUB4 sensor hub to the PX3.
 - a. Plug one end of the Raritan-provided phone cable (4-wire, 6-pin, RJ-12) into the IN port (Port 1) of the hub.
 - b. Get an RJ-12 to RJ-45 adapter. Connect this adapter's RJ-12 connector to the other end of the phone cable.
 - c. Connect this adapter's RJ-45 connector to the PDU's RJ-45 SENSOR port.

2. Connect DPX sensor packages to any of the four OUT ports on the hub.

This diagram illustrates a configuration with a sensor hub connected.

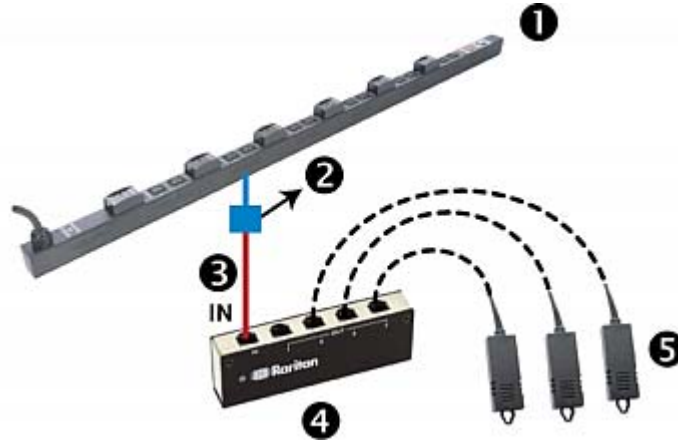

①	The PX3 device
②	RJ-12 to RJ-45 adapter
③	Raritan-provided phone cable
④	DPX-ENVHUB4 sensor hub
⑤	DPX sensor packages

Using an Optional DPX-ENVHUB2 cable

A Raritan *DPX-ENVHUB2* cable doubles the number of connected environmental sensors per SENSOR port.

This cable supports DPX sensor packages only. Do NOT connect DPX2, DPX3 or DX sensor packages to it.

► To connect DPX sensor packages via the DPX-ENVHUB2 cable:

1. Use an RJ-12 to RJ-45 adapter to connect the DPX-ENVHUB2 cable to the PX3.
 - a. Connect the adapter's RJ-12 connector to the cable.
 - b. Connect the adapter's RJ-45 connector to the RJ-45 SENSOR port on the PX3.

2. The cable has two RJ-12 sensor ports. Connect DPX sensor packages to the cable's sensor ports.

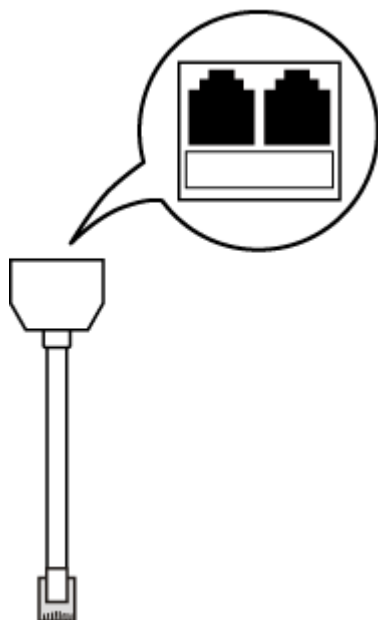

3. Repeat the above steps if there are additional SENSOR ports on your PX3.

Supported Maximum DPX Sensor Distances

When connecting the following DPX sensor packages to the PX3, you must follow two restrictions.

- DPX-CC2-TR
- DPX-T1
- DPX-T3H1
- DPX-AF1
- DPX-T1DP1

▶ **Sensor connection restrictions:**

- Connect a DPX sensor package to the PX3 using the sensor cable pre-installed (or provided) by Raritan. You **MUST NOT** extend or modify the sensor cable's length by using any tool other than the Raritan's sensor hubs.
- If using a DPX-ENVHUB4 sensor hub, the cabling distance between the PX3 and the sensor hub is up to 33' (10 m).

▶ **Maximum distance illustration:**

The following illustrates the maximum distance when connecting DPX sensor packages with a maximum 16' (5 m) sensor cable to a PX3 via a sensor hub.

- The sum of a DPX-T3H1 sensor cable's length is 16' (5 m).

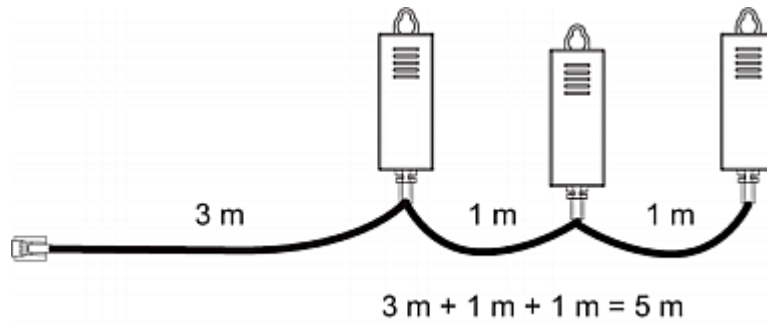

- The total cabling length between the PX3 and one DPX-T3H1 is 49' (15 m) as illustrated below.

Note that the length 16' (5 m) is the length of each DPX-T3H1 sensor cable, which is defined in the above diagram.

PX3 → 33' (10 m) cable → 1 sensor hub → 16' (5 m) cable → Up to 4 DPX-T3H1 sensor packages

DPX2 Sensor Packages

A DPX2 sensor cable is shipped with a DPX2 sensor package. This cable is made up of one RJ-12 connector and one to three head connectors. You have to connect DPX2 sensor packages to the sensor cable.

For more information on DPX2 sensor packages, access the Environmental Sensors Guide or Online Help on Raritan website's *Support page* (<http://www.raritan.com/support/>).

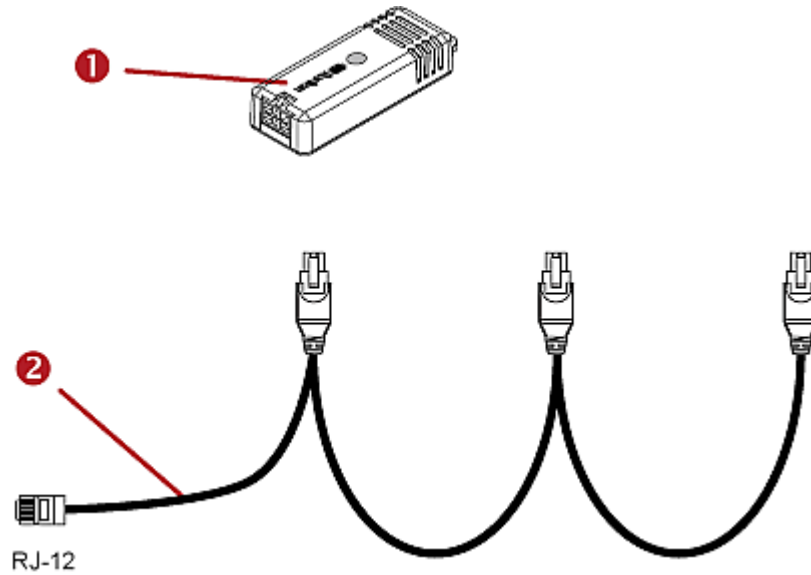

Item	
①	DPX2 sensor package
②	DPX2 sensor cable with one RJ-12 connector and three head connectors

The following procedure illustrates a DPX2 sensor cable with three head connectors. Your sensor cable may have fewer head connectors.

Warning: If there are free head connectors between a DPX2 sensor cable's RJ-12 connector and the final attached DPX2 sensor package, the sensor packages following the free head connector(s) on the same cable do NOT work properly. Therefore, always occupy all head connectors prior to the final sensor package with a DPX2 sensor package.

► **To connect DPX2 sensor packages to the PX3:**

1. Connect a DPX2 sensor package to the first head connector of the DPX2 sensor cable.

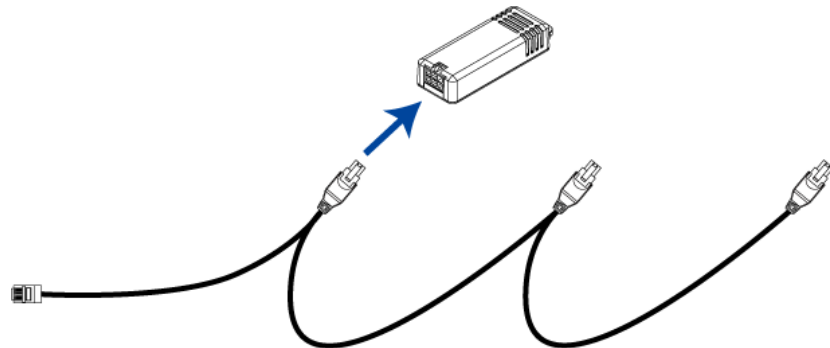

2. Connect remaining DPX2 sensor packages to the second and then the third head connector.

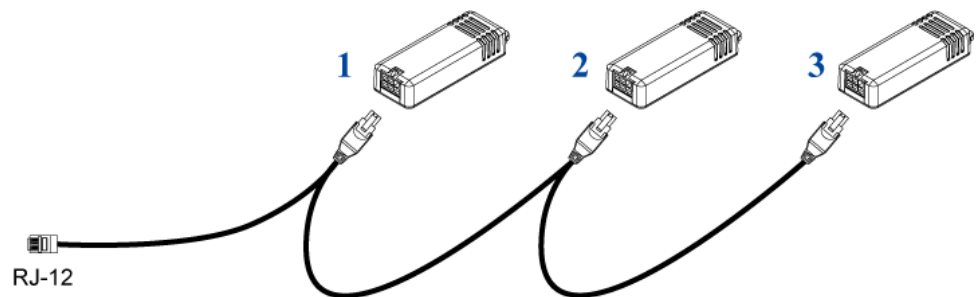

Tip: If the number of sensors you are connecting is less than the number of head connectors on your sensor cable, connect them to the first one or first two head connectors to ensure that there are NO free head connectors prior to the final DPX2 sensor package attached.

3. Use an RJ-12 to RJ-45 adapter to connect the DPX2 sensor package(s) to the PX3.
 - a. Connect the adapter's RJ-12 connector to the DPX2 sensor cable.

- b. Connect the adapter's RJ-45 connector to the RJ-45 SENSOR port of the PX3.

OR you can directly connect the DPX2 sensor package to a DX sensor chain without using any RJ-12 to RJ-45 adapter. See **Connecting a DPX2 Sensor Package to DX** (on page 65).

DPX3 Sensor Packages

A DPX3 sensor package features the following:

- Its connection interface is RJ-45.
- You can cascade a maximum of 12 DPX3 sensor packages.

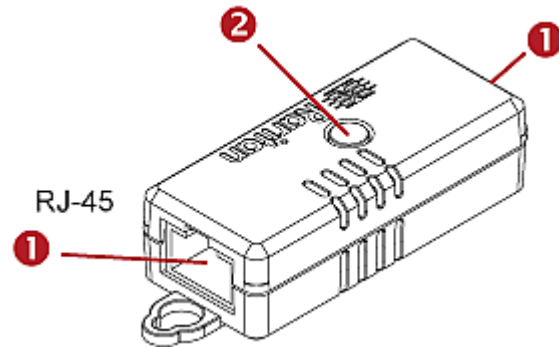

Numbers	Components
①	RJ-45 ports, each of which is located on either end of a DPX3 sensor package.
②	LED for indicating the sensor status.

► **To connect DPX3 sensor packages to the PX3:**

1. Connect a standard network patch cable (CAT5e or higher) to either RJ-45 port on the DPX3 sensor package.
2. If you want to cascade DPX3 sensor packages, get an additional standard network patch cable (CAT5e or higher) and then:
 - a. Plug one end of the cable into the remaining RJ-45 port on the prior DPX3.
 - b. Plug the other end into either RJ-45 port on an additional DPX3.

Repeat the same steps to cascade more DPX3 sensor packages.

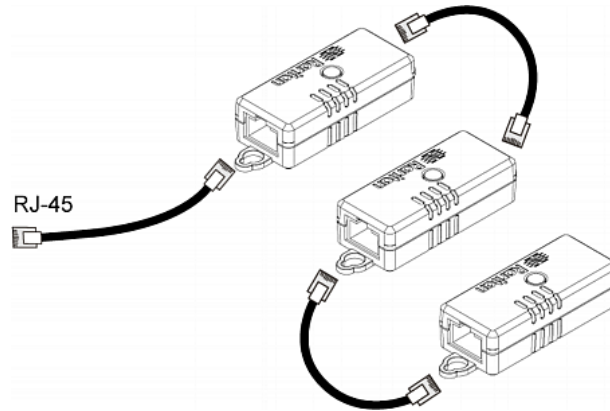

3. Connect the first DPX3 sensor package to the PX3 by plugging its cable's connector into the RJ-45 SENSOR port of the PX3.

Connecting a DPX2 Sensor Package to DPX3

You can connect only one DPX2 sensor package to the "end" of a DPX3 sensor chain. It is strongly recommended to use an RJ-12 to RJ-45 adapter for connecting the DPX2 to the final DPX3 in the chain.

The maximum number of DPX3 sensor packages in the chain must be less than 12 when a DPX2 sensor package is involved.

- ▶ **When connecting a DPX2 sensor package containing three DPX2 sensors:**

A maximum of nine DPX3 sensor packages can be cascaded because $12-3=9$.

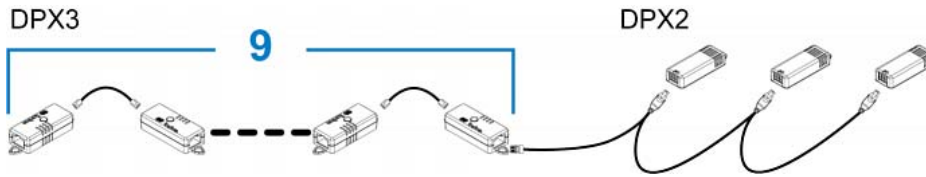

- ▶ **When connecting a DPX2 sensor package containing two DPX2 sensors:**

A maximum of ten DPX3 sensor packages can be cascaded because $12-2=10$.

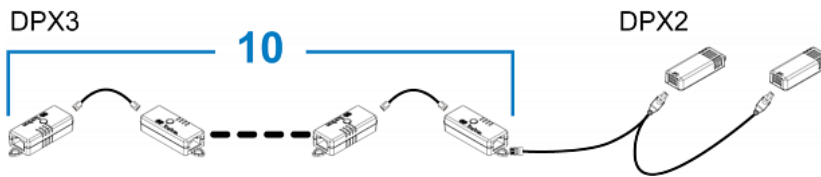

- ▶ **When connecting a DPX2 sensor package containing one DPX2 sensor:**

A maximum of eleven DPX3 sensor packages can be cascaded because $12-1=11$.

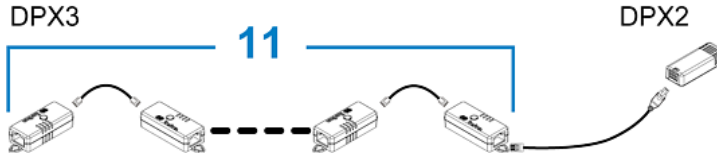

DX Sensor Packages

Most DX sensor packages contain terminals for connecting detectors or actuators. For information on connecting actuators or detectors to DX terminals, refer to the Environmental Sensors Guide or Online Help on Raritan website's *Support page* (<http://www.raritan.com/support/>).

You can cascade up to 12 DX sensor packages.

When cascading DX, remember that the PX3 only supports a maximum of 32 sensors and/or actuators.

If there are more than 32 sensors and/or actuators connected, every sensor and/or actuator after the 32nd one is NOT managed by the PX3.

For example, if you cascade 12 DX packages, and each package contains 3 functions (a function is a sensor or actuator), the PX3 does NOT manage the last 4 functions because the total 36 ($12 \times 3 = 36$) exceeds 32 by 4.

*Tip: To manage the last 4 functions, you can release 4 "managed" sensors or actuators, and then manually bring the last 4 functions into management. See **Peripherals** (on page 175).*

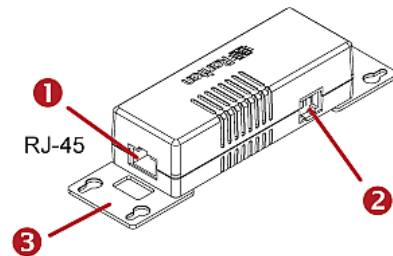

Numbers	Components
①	RJ-45 ports, each of which is located on either end of a DX sensor package.
②	RJ-12 port, which is reserved for future use and now blocked.

Numbers	Components
3	Removable rackmount brackets.

► **Connect DX sensor packages to the PX3:**

1. Connect a standard network patch cable (CAT5e or higher) to either RJ-45 port on a DX sensor package.
2. If you want to cascade DX packages, get an additional standard network patch cable (CAT5e or higher) and then:
 - a. Plug one end of the cable into the remaining RJ-45 port on the prior DX package.
 - b. Plug the other end into either RJ-45 port on an additional DX package.

Repeat the same steps to cascade more DX packages.

Exception: You CANNOT cascade DX-PD2C5 sensor packages. A PX3 device supports only one DX-PD2C5.

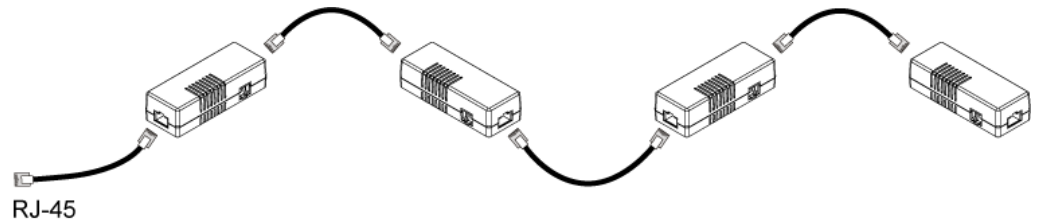

3. Connect the first DX sensor package to the PX3 by plugging its cable's connector into the RJ-45 SENSOR port of the PX3.
4. If needed, connect a DPX2 sensor package to the end of the DX chain. See **Connecting a DPX2 Sensor Package to DX** (on page 65).

Warning: The PX3 does NOT support simultaneous connection of both DX-PD2C5 and asset management strip(s) so do NOT connect both of them at the same time.

Connecting a DPX2 Sensor Package to DX

You can connect only one DPX2 sensor package to the "end" of a DX sensor chain. It is strongly recommended to use an RJ-12 to RJ-45 adapter for connecting the DPX2 to the final DX in the chain.

The maximum number of DX sensor packages in the chain must be less than 12 when a DPX2 sensor package is involved.

- ▶ **When connecting a DPX2 sensor package containing three DPX2 sensors:**

A maximum of nine DX sensor packages can be cascaded because $12-3=9$.

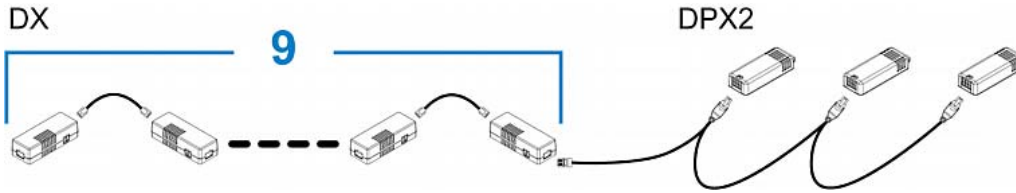

- ▶ **When connecting a DPX2 sensor package containing two DPX2 sensors:**

A maximum of ten DX sensor packages can be cascaded because $12-2=10$.

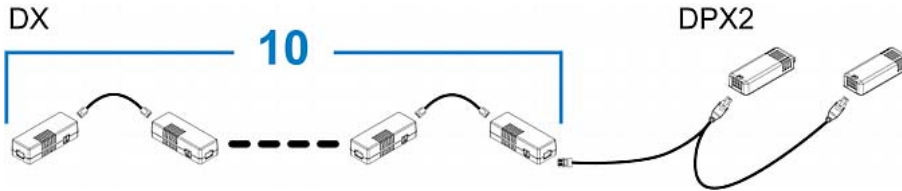

- ▶ **When connecting a DPX2 sensor package containing one DPX2 sensor:**

A maximum of eleven DX sensor packages can be cascaded because $12-1=11$.

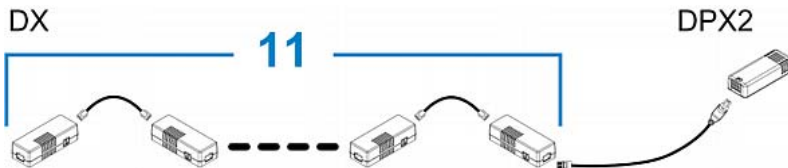

Using an Optional DPX3-ENVHUB4 Sensor Hub

A Raritan DPX3-ENVHUB4 sensor hub is physically and functionally similar to the DPX-ENVHUB4 sensor hub, which increases the number of sensor ports for the PX3, except for the following differences:

- All ports on the DPX3-ENVHUB4 sensor hub are RJ-45 instead of RJ-12 as the DPX-ENVHUB4 sensor hub.
- The DPX3-ENVHUB4 sensor hub supports all Raritan environmental sensor packages, including DPX, DPX2, DPX3 and DX sensor packages.

To connect diverse types of sensor packages to this sensor hub, you must follow the combinations shown in the section titled *Mixing Diverse Sensor Types* (on page 68).

► **To connect DPX3 sensor packages via the DPX3-ENVHUB4 hub:**

1. Connect the DPX3-ENVHUB4 sensor hub to the PX3 using a standard network patch cable (CAT5e or higher).
 - a. Plug one end of the cable into the IN port (Port 1) of the hub.
 - b. Plug the other end of the cable into the RJ-45 SENSOR port of the PX3.
2. Connect the Raritan sensor packages to any of the four OUT ports on the hub.
 - An RJ-12 to RJ-45 adapter is required for connecting a DPX or DPX2 sensor package to the hub.

This diagram illustrates a configuration with a sensor hub connected.

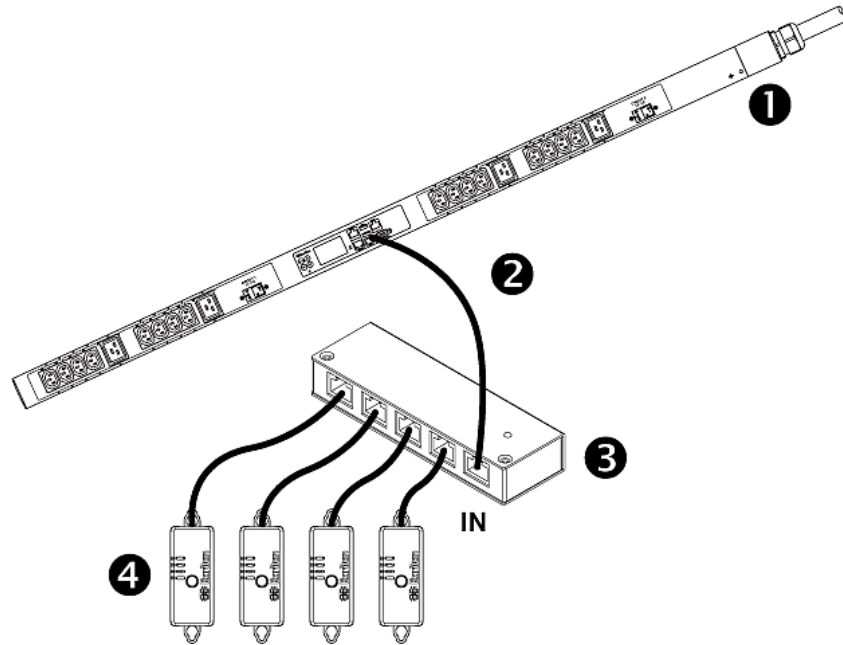

①	The PX3
②	A standard network cable
③	DPX3-ENVHUB4 sensor hub
④	Any Raritan sensor packages

Mixing Diverse Sensor Types

You can mix DPX, DPX2, DPX3 and DX sensor packages on one PX3 according to the following sensor combinations. In some scenarios, the DPX3-ENVHUB4 sensor hub is required.

The PX3 does NOT support any other sensor-mixing combinations than those described in this section.

When mixing different sensor types, remember that the PX3 supports a maximum of 32 sensors/actuators.

▶ **1 DX + 1 DPX:**

- It is strongly recommended to use an RJ-12 to RJ-45 adapter to connect the DPX sensor package to the DX sensor package.

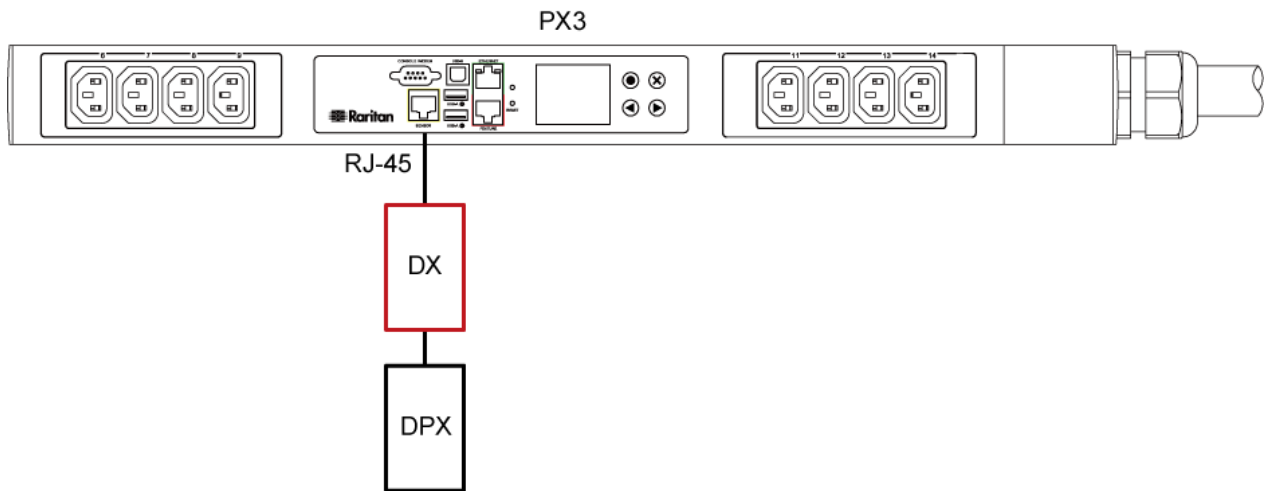

▶ **Diverse combinations via the DPX3-ENVHUB4 sensor hub:**

- You must use the **DPX3-ENVHUB4** sensor hub instead of the old DPX-ENVHUB4 sensor hub. Each port on the hub supports any of the following:
 - A DX sensor package
 - A chain of DX sensor packages
 - A DPX3 sensor package
 - A chain of DPX3 sensor packages
 - A DPX2 sensor package
 - A DPX sensor package

- An RJ-12 to RJ-45 adapter is recommended to connect a DPX or DPX2 sensor package to DPX3-ENVHUB4.
- In the following diagrams, the sensor package in "green" can be replaced by a DPX2 sensor package. The sensor package in "blue" can be one DPX2, DPX3 or DX sensor package.

This section only illustrates the following three combinations, but actually there are tens of different combinations by using the DPX3-ENVHUB4 sensor hub.

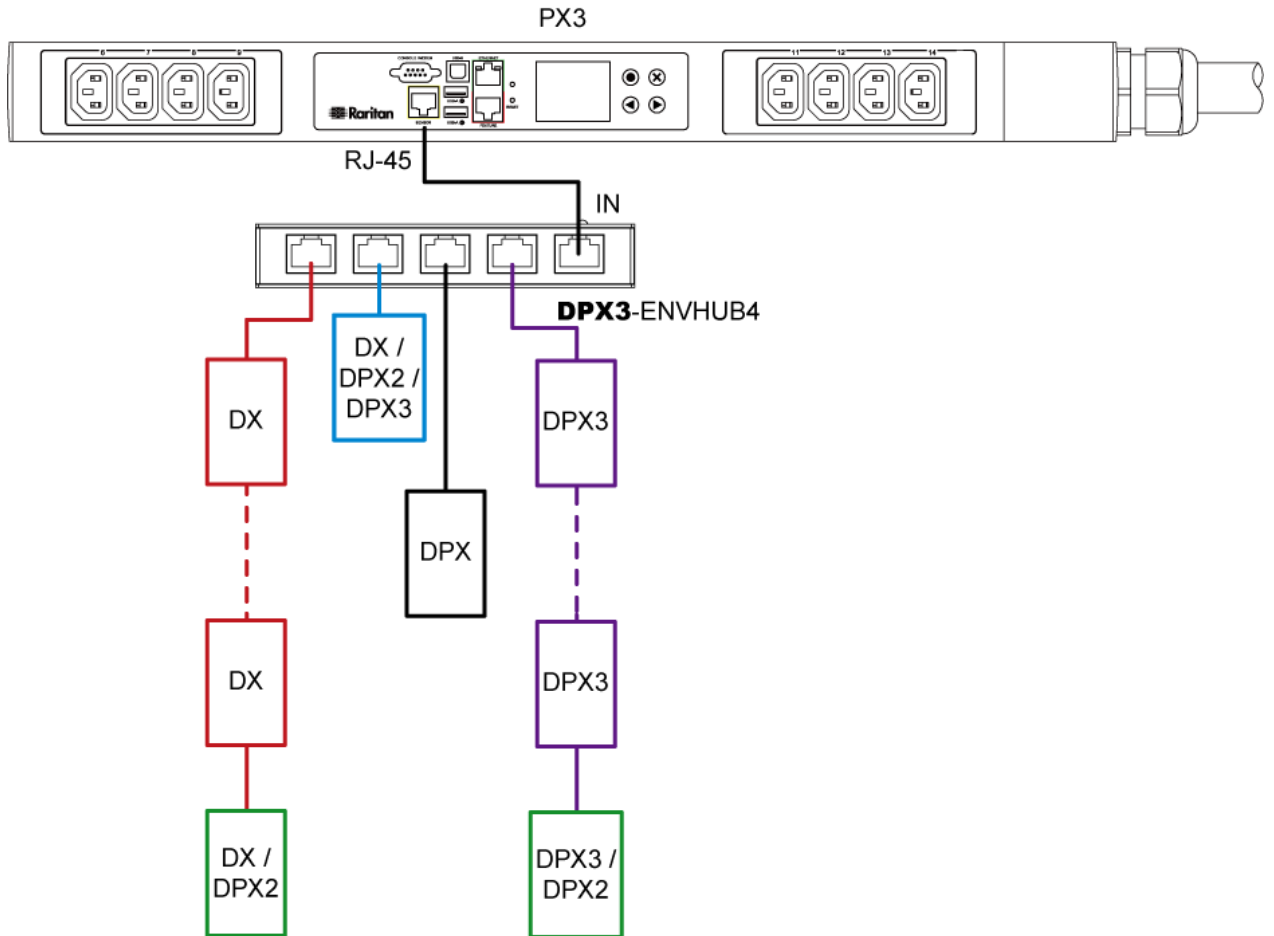

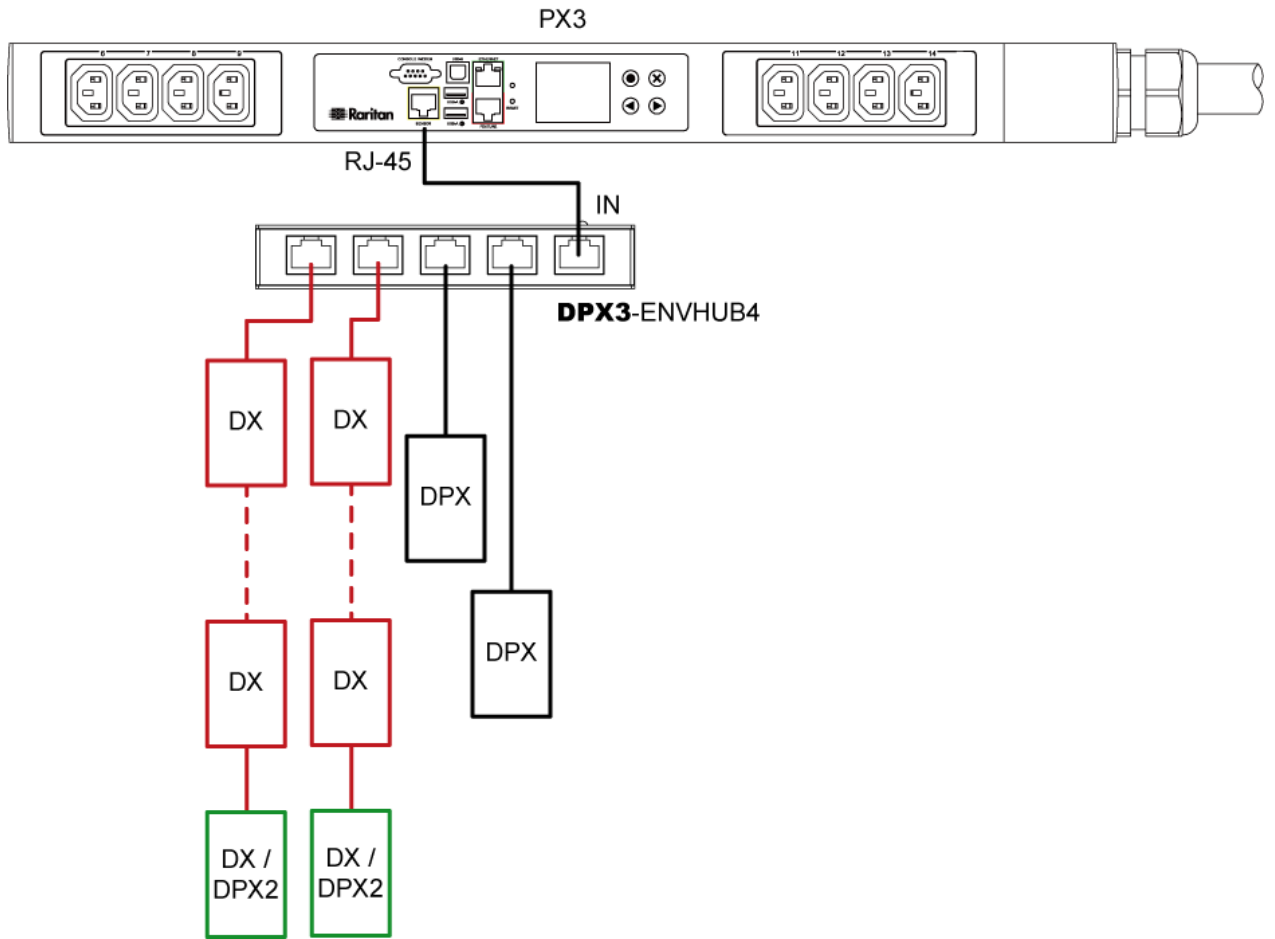

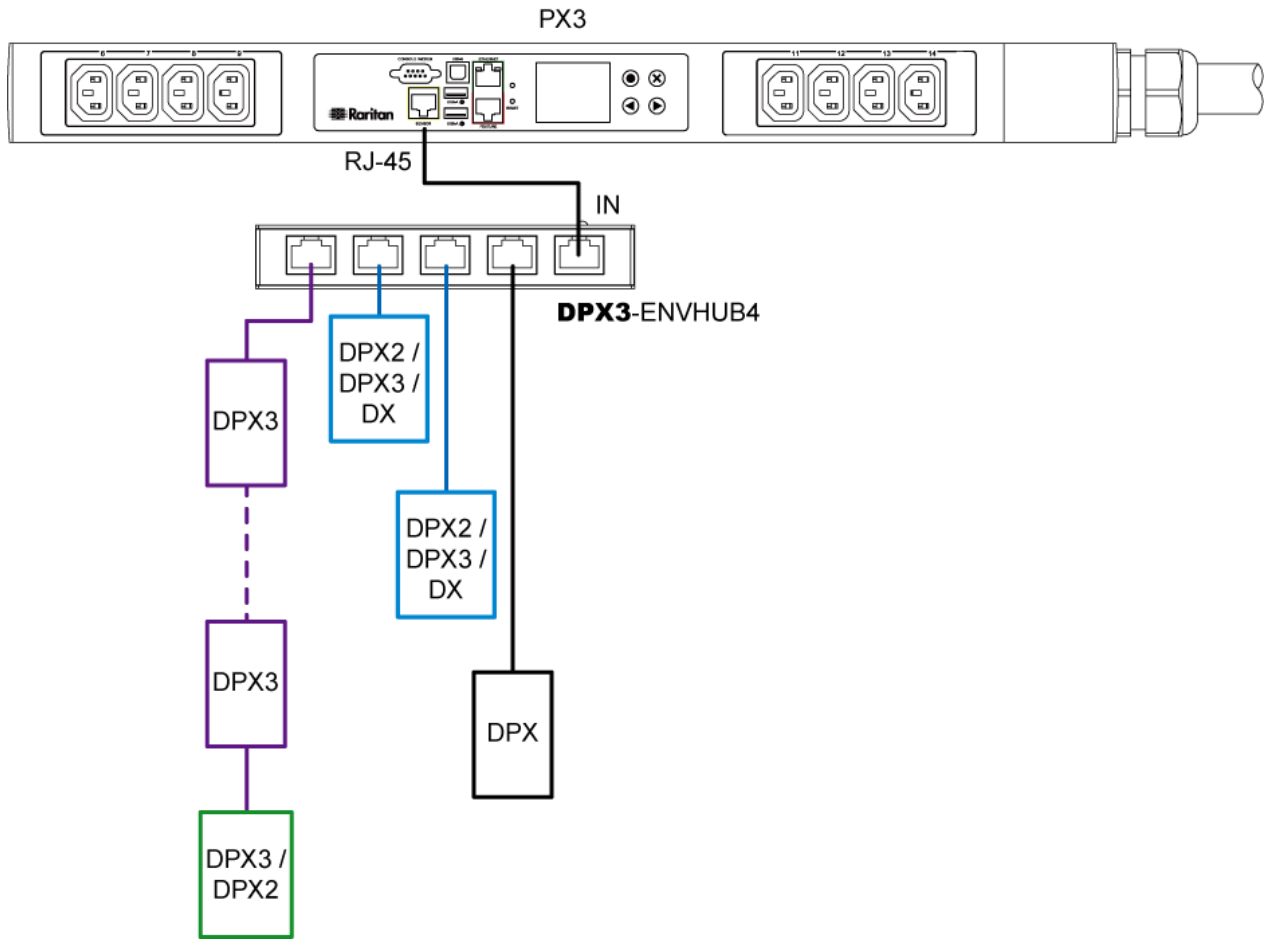

► **Mix DPX3 and DX in a sensor chain:**

Any DX sensor package in a chain can be replaced by a DPX3 sensor package, or vice versa. The total number of sensor packages in this chain cannot exceed 12.

For example, the following diagram shows a sensor chain comprising both DX and DPX3 sensor packages.



You can add a DPX2 sensor package to the end of such a sensor-mixing chain if intended. See *Connecting a DPX2 Sensor Package to DPX3* (on page 62) or *Connecting a DPX2 Sensor Package to DX* (on page 65).

Connecting Asset Management Strips

You can remotely track the locations of up to 64 IT devices in the rack by connecting asset management strips (asset strips) to the PX3 after IT devices are tagged electronically.

To use the asset management feature, you need the following items:

- *Raritan asset strips*: An asset strip transmits the asset management tag's ID and positioning information to the PX3.
- *Raritan asset tags*: An asset management tag (asset tag) is adhered to an IT device. The asset tag uses an electronic ID to identify and locate the IT device.

Warning: The PX3 does NOT support simultaneous connection of both DX-PD2C5 and asset management strip(s) so do NOT connect both of them at the same time.

Combining Regular Asset Strips

Each tag port on the regular asset strips corresponds to a rack unit and can be used to locate IT devices in a specific rack (or cabinet).

For each rack, you can attach asset strips up to 64U long, consisting of one MASTER and multiple SLAVE asset strips.

The difference between the master and slave asset strips is that the master asset strip has an RJ-45 connector while the slave does not.

The following diagram illustrates some asset strips. Note that Raritan provides more types of asset strips than the diagram.

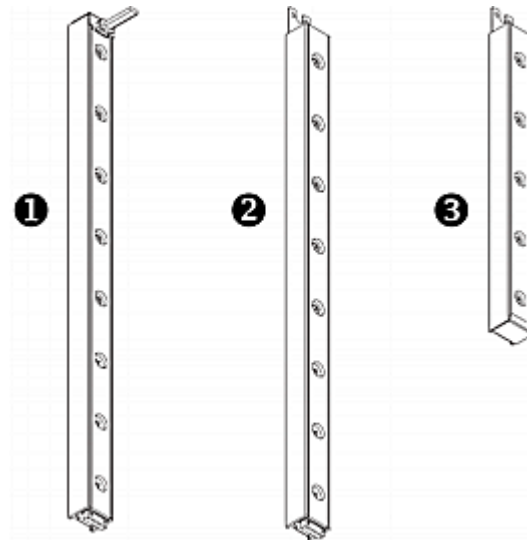

1	8U MASTER asset strip with 8 tag ports
2	8U SLAVE asset strip with 8 tag ports
3	5U "ending" SLAVE asset strip with 5 tag ports

Note: Unlike general slave asset strips, which have one DIN connector respectively on either end, the ending slave asset strip has one DIN connector on only one end. An ending asset strip is installed at the end of the asset strip assembly.

► **To assemble asset strips:**

1. Connect a MASTER asset strip to an 8U SLAVE asset strip.
 - Plug the white male DIN connector of the slave strip into the white female DIN connector of the master strip.
 - Make sure that the U-shaped sheet metal adjacent to the male DIN connector is inserted into the rear slot of the master strip. Screw up the U-shaped sheet metal to reinforce the connection.

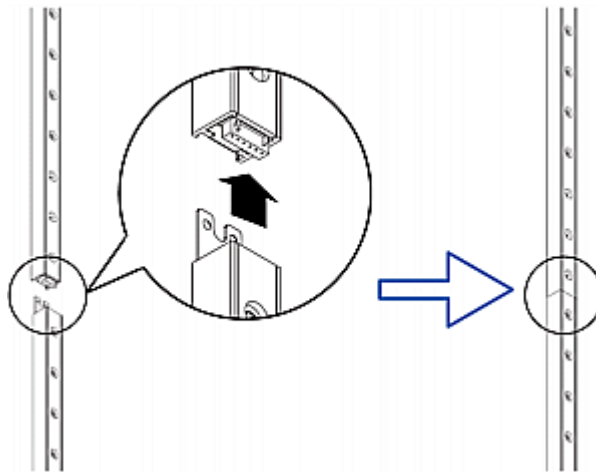

2. Connect another 8U slave strip to the one being attached to the master strip in the same manner as Step 1.
3. Repeat the above step to connect more slave strip. The length of the asset strip assembly can be up to 64U.
 - The final slave strip can be 8U or 5U, depending on the actual height of your rack.
 - Connect the "ending" asset strip as the final one in the assembly.
4. Vertically attach the asset strip assembly to the rack, next to the IT equipment, making each tag port horizontally align with a rack unit.
5. The asset strips are automatically attracted to the rack because of magnetic stripes on the back.

Note: The asset strip is implemented with a tilt sensor so it can be mounted upside down.

Introduction to Asset Tags

You need both asset strips and asset tags for tracking IT devices.

Asset tags provide an ID number for each IT device. The asset tags are adhered to an IT device at one end and plugged in to an asset strip at the other.

The asset strip is connected to the PX3, and the asset tag transmits the ID and positioning information to the asset strip.

The following diagram illustrates an asset tag. Note that there are two types of asset tags: non-programmable and programmable tags. The only difference is that programmable asset tags allow you to customize each tag's ID or barcode number while non-programmable ones have factory default ID or barcode numbers, which you cannot change.



A	Barcode (ID number), which is available on either end of the "non-programmable" asset tag
B	Tag connector
C	Adhesive area with the tape

Note: The barcode of each "non-programmable" asset tag is unique and is displayed in the PX3 device's web interface for identification.

Connecting Regular Asset Strips to PX3

The cabling distance between an asset strip assembly and the PX3 can be up to 10 meters.

► **To connect regular asset strips to the PX3 device:**

1. Affix the adhesive end of an asset tag to each IT device through the tag's tape.
2. Plug the connector of each asset tag into the corresponding tag port on the asset strip.

3. Connect the asset strip assembly to the PX3 device, using a network patch cable (CAT5e or higher).
 - Connect one end of the cable to the RJ-45 connector on the MASTER asset strip.
 - Connect the other end of the cable to the FEATURE port on the PX3 device.

The PX3 device supplies power to the connected asset strip assembly. All LEDs on the asset strip assembly may cycle through different colors during the power-on process if the asset strip's firmware is being upgraded by the PX3. After the power-on or firmware upgrade process completes, the LEDs show solid colors. Note that the LED color of the tag ports with asset tags connected will be different from the LED color of the tag ports without asset tags connected.

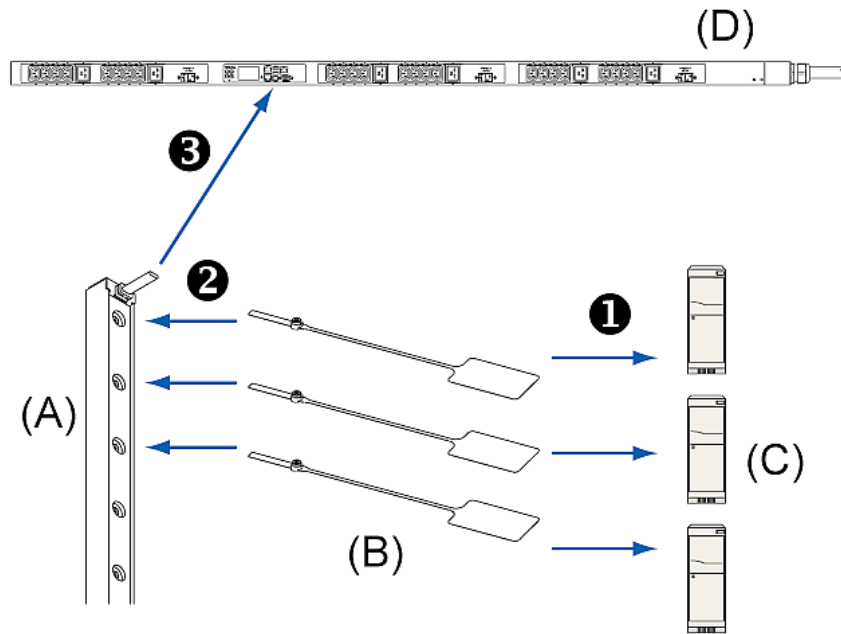

(A)	MASTER asset strip
(B)	Asset tags
(C)	IT devices
(D)	PX3

Connecting Blade Extension Strips

For blade servers, which are contained in a single chassis, you can use a blade extension strip to track individual blade servers.

Raritan's blade extension strip functions similar to a Raritan asset strip but requires a tag connector cable for connecting it to a tag port on the regular or composite asset strip. A blade extension strip contains 4 to 16 tag ports.

The following diagrams illustrate a tag connector cable and a blade extension strip with 16 tag ports.

Tag connector cable

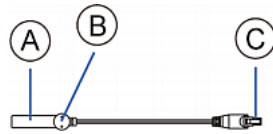

A	Barcode (ID number) for the tag connector cable
B	Tag connector
C	Cable connector for connecting the blade extension strip

Note: A tag connector cable has a unique barcode, which is displayed in the PX3 device's web interface for identifying each blade extension strip where it is connected.

Blade extension strip with 16 tag ports

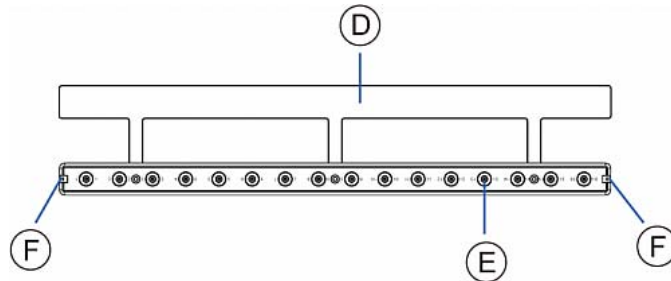

D	Mylar section with the adhesive tape
E	Tag ports
F	Cable socket(s) for connecting the tag connector cable

Note: Each tag port on the blade extension strip is labeled a number, which is displayed as the slot number in the PX3 device's web interface.

► **To install a blade extension strip:**

1. Connect the tag connector cable to the blade extension strip.
 - Plug the cable's connector into the socket at either end of the blade extension strip.

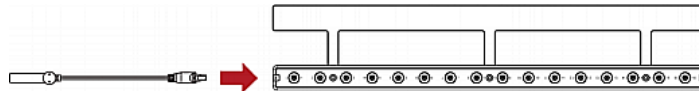

2. Move the blade extension strip toward the bottom of the blade chassis until its mylar section is fully under the chassis, and verify that the blade extension strip does not fall off easily. If necessary, you may use the adhesive tape in the back of the mylar section to help fix the strip in place.

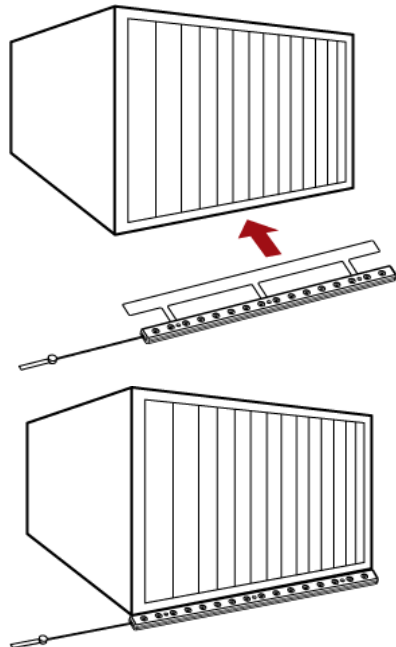

3. Connect one end of an asset tag to a blade server and the other end to the blade extension strip.

- a. Affix the adhesive part of the asset tag to one side of a blade server through the tag's tape.
- b. Plug the tag connector of the asset tag into a tag port on the blade extension strip.

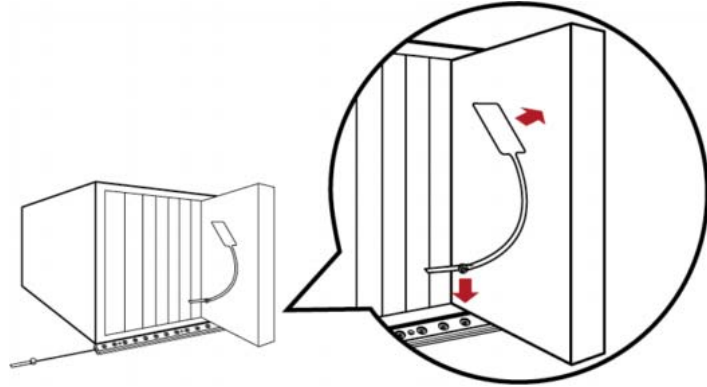

4. Repeat the above step until all blade servers in the chassis are connected to the blade extension strip via asset tags.
5. Plug the tag connector of the blade extension strip into the closest tag port of the regular or composite asset strip on the rack.

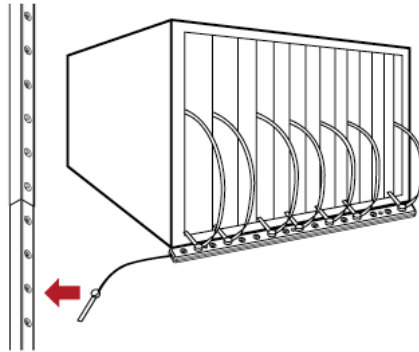

6. Repeat the above steps to connect additional blade extension strips. Up to 128 asset tags on blade extension strips are supported per FEATURE port.

Note: If you need to temporarily disconnect the blade extension strip from the asset strip, wait at least 1 second before re-connecting it back, or the PX3 device may not detect it.

Connecting Composite Asset Strips

A composite asset strip is named AMS-Mx-Z, where x is a number, such as AMS-M2-Z or AMS-M3-Z. It is a type of asset strip that functions the same as regular MASTER asset strips except for the following differences:

- It has two RJ-45 connectors.
- Multiple composite asset strips can be daisy chained.
- It contains less tag ports than regular asset strips.

For example, AMS-M2-Z contains two tag ports, and AMS-M3-Z contains three tag ports only.

The composite asset strip is especially useful for tracking large devices such as SAN boxes in the cabinet.

The following diagram illustrates AMS-M3-Z.

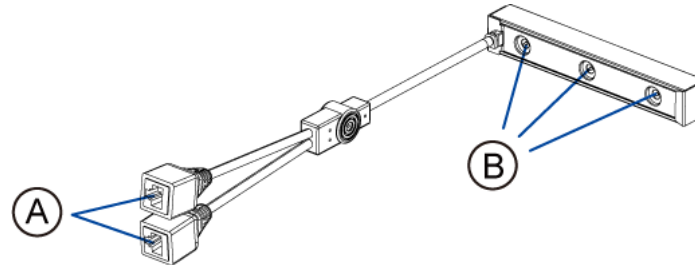

A	Two RJ-45 connectors
B	Tag ports

► To connect composite asset strips to the PX3 device:

1. Connect a composite asset strip to the PX3 device via a standard network patch cable (CAT5e or higher).
 - a. Connect one end of the cable to the RJ-45 port labeled "Input" on the composite asset strip.
 - b. Connect the other end of the cable to the FEATURE port on the PX3 device.
2. Affix an asset tag to the IT device. Then connect this asset tag to the composite asset strip by plugging the tag connector into the tag port on the composite asset strip. For details, see *Connecting Regular Asset Strips to the PX3* (see "Connecting Regular Asset Strips to PX3" on page 74).
3. If necessary, daisy chain additional composite asset strips to track more IT devices.
 - a. Get a standard network patch cable that is within 2 meters.

- b. Connect one end of the network cable to the RJ-45 connector labeled "Output" on the previous composite asset strip.
- c. Connect the other end of the cable to the RJ-45 connector labeled "Input" on the subsequent composite asset strip.
- d. Repeat the above steps to connect more composite asset strips. See ***Daisy-Chain Limitations of Composite Asset Strips*** (on page 80) for the maximum number of composite asset strips supported per chain.
- e. It is highly recommended using the cable ties to help hold the weight of all connecting cables.

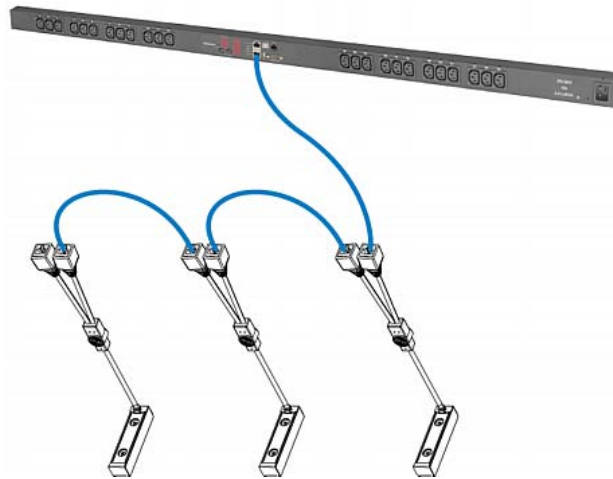

4. Repeat Step 2 to connect IT devices to the other composite asset strips in the chain.

Important: Different types of composite asset strips can be mixed in a chain only when the PX3 is upgraded to version 3.3.0 or later.

Daisy-Chain Limitations of Composite Asset Strips

There are some limitations when daisy chaining composite asset strips "AMS-Mx-Z," where x is a number.

- The maximum cable length between composite asset strips is 2 meters, but the total cable length cannot exceed 10 meters.
- The maximum number of composite asset strips that can be daisy chained depend on the Raritan product you purchased.

Raritan devices	Maximum strips per chain
EMX2-111, PX2 PDUs, BCM1 (NOT BCM2)	Up to 4 composite asset strips are supported.

Raritan devices series)	Maximum strips per chain
EMX2-888, PX3 PDUs, PX3TS transfer switches PMC (BCM2 series)	Up to 6 composite asset strips are supported.

Important: Different types of composite asset strips can be mixed in a chain as of release 3.3.0.

Connecting a Logitech Webcam

Connect webcams to PX3 in order to view videos or snapshots of the webcam's surrounding area.

The following USB Video Class (UVC) compliant webcam is supported:

- Logitech® Webcam® Pro 9000, Model 960-000048

Other UVC-compliant webcams may also work. However, Raritan has neither tested them nor claimed that they will work properly.

Tip: You can easily find a list of UVC-compliant webcams on the Internet.

The PX3 supports up to two webcams. After connecting a webcam, you can retrieve visual information from anywhere through the PX3 web interface. If your webcam supports audio, audio is available with videos.

For more information on the Logitech webcam, see the user documentation accompanying it.

► To connect a webcam:

1. Connect the webcam to the USB-A port on the PX3 device. The PX3 automatically detects the webcam.
2. Position the webcam properly.

Important: If a USB hub is used to connect the webcam, make sure it is a "powered" hub.

Snapshots or videos captured by the webcam are immediately displayed in the PX3 web interface after the connection is complete. See *Configuring Webcams and Viewing Live Images* (on page 352).

Connecting a GSM Modem

The following Cinterion® GSM modems can be connected to the PX3 in order to send SMS messages containing event information.

- MC52iT
- MC55iT
- EHS6

See **Available Actions** (on page 289) for more information on SMS messages.

Note: PX3 cannot receive SMS messages.

▶ **To connect the GSM modem:**

1. Connect the GSM modem to the serial port labeled CONSOLE / MODEM on the PX3.
 - For iX7™, a third party RJ-45 to "DB9 male" adapter/cable is required for this connection. See **RJ45-to-DB9 Cable Requirements for Modem Connections (for iX7™ Only)** (on page 670).
2. Configure the GSM modem as needed. See the supporting GSM modem help for information on configuring the GSM modem.
3. Configure the GSM modem settings in the PX3 to specify the modem's SIM PIN number and the recipient phone number. See **Configuring the Serial Port** (on page 325).

Connecting an Analog Modem

The PX3 supports remote dial-in communications to access the CLI through an analog modem. This dial-in feature provides an additional alternative to access the PX3 when the LAN access is not available. To dial in to the PX3, the remote computer must have a modem connected and dial the correct phone number.

Below are the analog modems that the PX3 supports for sure:

- NETCOMM IG6000 Industrial Grade SmartModem
- US Robotics 56K modem

The PX3 may also support other analog modems which Raritan did not test.

Note that the PX3 does NOT support dial-out or dial-back operations via the modem.

▶ **To connect an analog modem:**

1. Plug a telephone cord into the phone jack of the supported modem.
2. Plug the modem's RS-232 cable into the serial port labeled CONSOLE / MODEM on the PX3.
 - For iX7™, a third party RJ-45 to "DB9 male" adapter/cable is required for this connection. See *RJ45-to-DB9 Cable Requirements for Modem Connections (for iX7™ Only)* (on page 670).

You need to enable the modem dial-in support to take advantage of this feature, see *Configuring the Serial Port* (on page 325).

Connecting an External Beeper

The PX3 supports the use of an external beeper for audio alarms.

External beepers that are supported include but may not be limited to the following:

- Mallory Sonalert MODEL SNP2R

After having an external beeper connected, you can create event rules for the PX3 to switch on or off the external beeper when specific events occur. See *Event Rules and Actions* (on page 272).

▶ **To connect an external beeper:**

1. Connect a standard network patch cable to the FEATURE port of the PX3.
2. Plug the other end of the cable into the external beeper's RJ-45 socket.

The beeper can be located at a distance up to 330 feet (100 m) away from the PX3.

Connecting a Schroff LHX/SHX Heat Exchanger

To remotely monitor and administer the Schroff® LHX-20, LHX-40 and SHX-30 heat exchangers through the PX3 device, you must establish a connection between the heat exchanger and the PX3 device.

For more information on the LHX/SHX heat exchanger, see the user documentation accompanying that product.

To establish a connection between the PDU and LHX/SHX heat exchanger, an RJ-45 to RS-232 adapter cable provided by Schroff is required.

► **To connect an LHX or SHX heat exchanger:**

1. Plug the RS-232 DB9 end of the adapter cable into the RS-232 port on the Schroff LHX/SHX heat exchanger.
2. Plug the RJ-45 end of the cable into the port labeled FEATURE on your PX3 device.

To enable the support of the LHX/SHX heat exchanger, see *Miscellaneous* (on page 332).

Chapter 5 Introduction to PDU Components

This chapter explains how to use the PX3 device, including:

- Introduction to the LEDs and ports on the PDU
- Operation of the front panel display
- The overcurrent protector's behavior
- The internal beeper's behavior
- The reset button

In This Chapter

Panel Components	85
Circuit Breakers	118
Fuse.....	120
Beeper.....	123
Replaceable Controller.....	124

Panel Components

The PX3 comes in Zero U, 1U, and 2U sizes. All types of models come with the following components on the outer panels.

- Inlet
- Outlets
- Connection ports
- Dot-matrix LCD display
- Reset button

Connection ports, LCD display and reset button are located on a replaceable controller of the PX3 model. See *Replaceable Controller* (on page 124).

Inlet

Most of PX3 PDUs are shipped with a locking line cord, which is ready to be plugged into the PDU's inlet and an appropriate receptacle for electricity reception. Such devices cannot be rewired by the user.

A locking line cord helps secure the cord connection. For details, see ***Connecting a Locking Line Cord*** (on page 16).

Connect each PX3 to an appropriately rated branch circuit. See the label or nameplate affixed to your PX3 for appropriate input ratings or range of ratings.

There is no power switch on the PX3 device. To power cycle the PDU, unplug it from the branch circuit, wait 10 seconds and then plug it back in.

Besides, a PX3 "Zero U" model supports a relocatable inlet. See ***Zero U Models' Relocatable Inlet*** (on page 86).

Zero U Models' Relocatable Inlet

You can easily change the inlet's location from the side to the top or from the top to the side on a Zero U model.

► **To change a PX3 inlet's position:**

1. Power OFF the PDU.
2. Remove the screws at two sides of the inlet to uninstall the inlet module.
3. Re-install the inlet module in a manner that the inlet is located at the desired position.

Inlet on the side

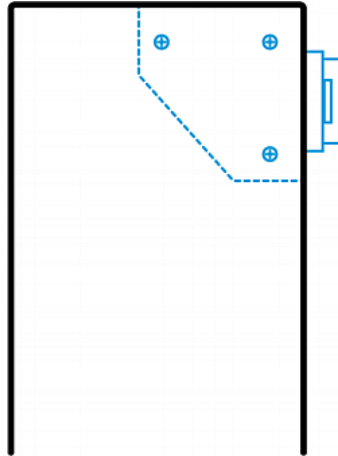

Inlet on the top

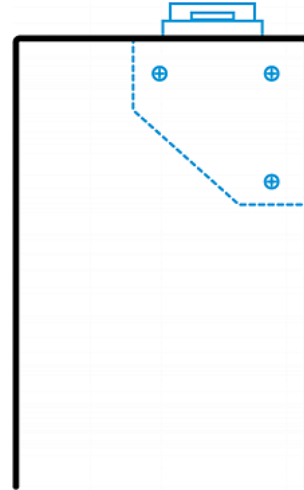

Outlets

The total number of outlets varies from model to model.

PX3-1000 Series

These models are NOT outlet-switching capable so all outlets are always in the ON state.

Outlet LEDs are not available.

PX3-2000 Series

These models are outlet-switching capable. A small LED is adjacent to each outlet to indicate the state of the relay board.

LED state	Outlet status	What it means
Not lit	Powered OFF	The outlet is not connected to power, or the control circuitry's power supply is broken.
Red	ON and LIVE	LIVE power. The outlet is on and power is available.
	ON and NOT LIVE	The outlet is turned on but power is not available because a circuit breaker has tripped.

Connection Ports

Depending on the model you purchased, the total number of ports available varies.

Zero U Connection Ports

The total number of connection ports depends on the model you purchased. Note that port locations on your models may be different from these images.

▶ 7 ports on PX3 models:

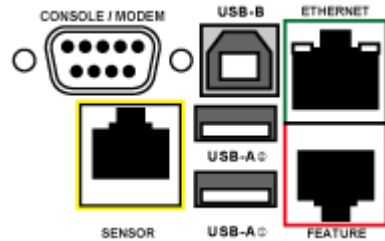

- CONSOLE/MODEM port x 1 (DB9)
- Sensor port x 1 (yellow)
- USB-A port x 2
- USB-B port x 1
- Feature port x 1 (red)
- Ethernet port x 1 (green)

▶ 9 ports on PX3-iX7 models:

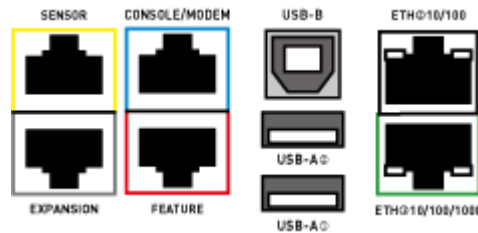

- CONSOLE/MODEM port x 1 (RJ-45)
- Sensor port x 1 (yellow)
- USB-A port x 2
- USB-B port x 1
- Feature port x 1 (red)
- Ethernet port x 2 (green and white)

Note: ETH①10/100/1000 (marked in green) supports up to 1000 Mbps. This is "ETH1". ETH②10/100 (marked in white) supports up to 100 Mbps. This is "ETH2".

- Expansion port x 1 (gray)

1U and 2U Port Locations

The difference between Zero U, 1U and 2U models is that Zero U models have all the connection ports located on the front panel while most of the 1U and 2U models have the ports located respectively on the front and back panels.

Connection Port Functions

The table below explains the function of each port.

► PX3 models:

Port	Used for...
USB-B	<ul style="list-style-type: none"> • Cascading the PX3 devices for sharing a network connection. See <i>Cascading the PX3 via USB</i> (on page 40). • Establishing a USB connection between a computer and the PX3 for using the command line interface or performing the disaster recovery. For disaster recovery instructions, contact Raritan Technical Support.
USB-A	<p>This is a "host" port, which is powered, per USB 2.0 specifications.</p> <ul style="list-style-type: none"> • Connecting a USB device, such as a Logitech® webcam or wireless LAN adapter. • Cascading the PX3 devices for sharing a network connection.
FEATURE	<p>Connection to one of the following devices:</p> <ul style="list-style-type: none"> ▪ A Raritan access product, such as Dominion KX III KVM switch, with the use of a power CIM. ▪ A Schroff® LHX-20, SHX-30 or LHX-40 device, using an RJ-45 to RS-232 cable provided by Schroff. ▪ An external beeper with the RJ-45 socket. ▪ A Raritan asset management strip, which allows you to track the locations of IT devices on the rack. <p>See <i>Connecting External Equipment (Optional)</i> (on page 53).</p> <p>Warning: This is not an RS-232 port so do NOT plug in an RS-232 device, or damages can be caused to the device.</p>

Port	Used for...
CONSOLE/ MODEM (DB9)	Establishing a serial connection between the PX3 and a computer or modem. This is a standard DTE RS-232 port. You can use a null-modem cable with two DB9 connectors on both ends to connect the PX3 to the computer.
SENSOR (RJ-45)	Connection to one of the following devices: <ul style="list-style-type: none"> ▪ Raritan's environmental sensor package(s). ▪ Raritan's sensor hub, which expands the number of a sensor port to four ports.
ETHERNET	Connecting the PX3 to your company's network via a standard network patch cable (Cat5e/6). This connection is necessary to administer or access the PX3 remotely. There are two small LEDs adjacent to the port: <ul style="list-style-type: none"> ▪ Green indicates a physical link and activity. ▪ Yellow indicates communications at 10/100 BaseT speeds. <hr/> <p><i>Note: Connection to this port is not required if wireless connection is preferred, or if the PX3 is a slave device in the USB-cascading configuration. See Cascading the PX3 via USB (on page 40).</i></p>

► **PX3-iX7 models:**

Port	Used for
USB-A, USB-B, FEATURE, SENSOR	Same functions as above.
CONSOLE/MODEM (RJ-45)	Same function as the one on PX3 models. See above. Note that the CONSOLE/MODEM port on the iX7™ PDU is an RJ-45 connector instead of a DB9 connector. Therefore, use a third-party RJ-45 to DB9 adapter/cable to connect iX7™ to the computer. See RJ45-to-DB9 Cable Requirements for Computer Connections (for iX7™ Only) (on page 30).

Port	Used for
ETH①10/100/1000, ETH②10/100	<p>iX7™ has two Ethernet ports.</p> <ul style="list-style-type: none"> ▪ ETH①10/100/1000 (marked in <i>green</i>) supports up to 1000 Mbps. This is "ETH1". ▪ ETH②10/100 (marked in <i>white</i>) supports up to 100 Mbps. This is "ETH2". <p>You can use either Ethernet port for network connection or cascading. See <i>Extended Cascading with PX3-iX7 Models</i> (on page 42).</p> <hr/> <p><i>Note: The yellow LED of the ETH②10/100 port has NO function so it will not be lit regardless of the communication status.</i></p>
EXPANSION	<p>Connecting to the EXPANSION port of another iX7™ so that the power supply to either iX7™ controller will continue whenever power failure occurs on the inlet of one iX7™ PDU. See <i>Power-Sharing Restrictions and Connection (for iX7™ Only)</i> (on page 47).</p>

Dot-Matrix LCD Display

The following diagram shows the dot-matrix LCD display panel on different Zero U models.

▶ PX3 models:

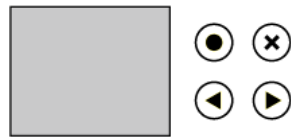

▶ PX3-iX7 models:



You can use the LCD display to view the PX3 information and even switch an outlet. It consists of:

- A dot-matrix LCD display
- Four control buttons

Note 1: All dot-matrix LCD display diagrams illustrated in the User Guide are for Zero U models. Your dot-matrix LCD may look slightly different if it is a 1U/2U model.

Zero U models automatically adjust the orientation of the content shown on the dot-matrix LCD display after detecting the direction in which the PDU is installed. 1U and 2U models do NOT adjust the content's orientation.

*Note 2: For information on the character LCD display of the PX3 'phase I' model, see **Old PX3 Character LCD Display** (on page 602).*

Automatic and Manual Modes

After powering on or resetting the PX3, the front panel LCD display first shows the Raritan logo, and then enters the automatic mode.

▶ Automatic mode without alerts available:

In this mode, the LCD display cycles through the inlet information as long as there are no alerts.

If overcurrent protectors are available on your PX3, the display cycles between both the inlet and overcurrent protector information.

*Note: You can make a PX3 with overcurrent protectors show the inlet information only in the automatic mode. See **Front Panel Settings** (on page 324).*

▶ Manual mode:

To view more information or control outlets if your PX3 is outlet-switching capable, enter the manual mode.

Press  or  to enter the manual mode, where the Main Menu is first displayed. See **Main Menu** (on page 96).

To return to the automatic mode, press  once or multiple times.

▶ When an alert exists:









- In the automatic mode, when an alert occurs, the LCD display stops cycling through the inlet information, and warns you by showing the alerts notice in a yellow or red background. See **Alerts Notice in a Yellow or Red Screen** (on page 116).

To enter the manual mode, press .

- In the manual mode, both the top and bottom bars will turn yellow or red to indicate the presence of any alert. See **Operating the Dot-Matrix LCD Display** (on page 95).

Control Buttons

Use the control buttons to navigate to the menu in the manual mode.

PX3 button	PX3-iX7 button	Function
		Up
		Down
		OK
		Back -- OR -- Switch between automatic and manual modes

Operating the Dot-Matrix LCD Display

Enter manual mode when you want to operate the dot-matrix LCD display. You can use the dot-matrix LCD display to:

- Show information of the PDU, built-in components, or connected peripheral devices
- Control outlets if your model supports outlet-switching
- Control actuators if any

► **Color changes of the display's top and bottom bars:**

- In the manual mode, both the top and bottom bars will turn yellow or red to indicate the presence of any alert. For color definitions, see *Yellow- or Red-Highlighted Sensors* (on page 180).

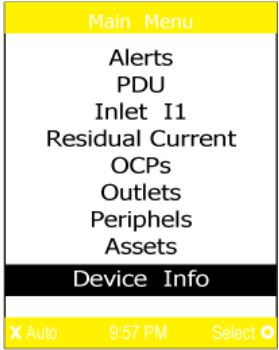
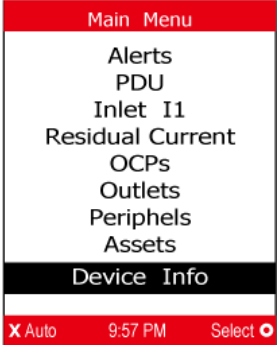
Screen with yellow bars	Screen with red bars
<p>All alerts enter the warning level only.</p> 	<p>Partial or all alerts enter the critical level.</p> 

- Both bars turn black when there are NO alerts.

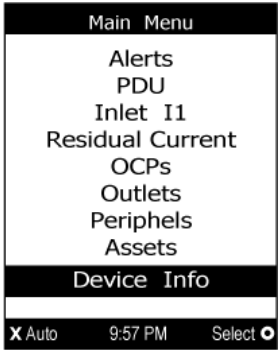
Screen with black bars

Main Menu

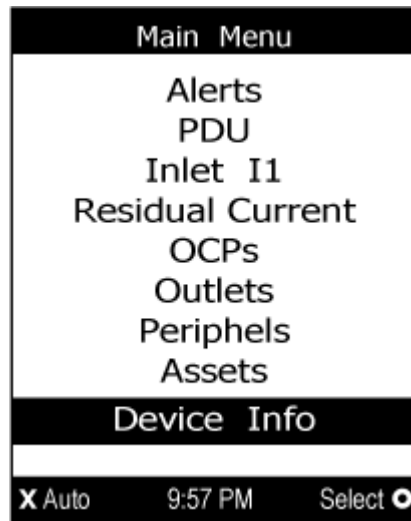

The Main Menu contains 6 to 9 menu commands, depending on the model.

Control buttons that can be used and the system time are shown at the bottom of the LCD display.



If any alerts exist, the top and bottom bars on the LCD display change the color from black to yellow or red. See *Operating the Dot-Matrix LCD Display* (on page 95).

Menu command	Function
Alerts	Indicates all alerted sensors, if any. See Alerts (on page 98).
PDU	Shows the internal beeper's state, and, if it is on, the reason for turning on. If your PX3 has multiple inlets, this menu item also shows the total active power and total active energy. See PDU (on page 99).
Inlet I1	Shows the inlet I1's information. See Inlet (on page 101).
Residual Current	Available only on PX3 models supporting residual current monitoring. See Front Panel Operations for RCM (on page 594).
OCPs	Shows a list of overcurrent protector information. See OCPs (on page 103). Only PX3 models with overcurrent protectors have this menu item.
Outlets	<div style="background-color: #f0f0f0; padding: 5px;">This menu command is NOT available on PX3-1000 and PX3-2000 series.</div> Shows each outlet's information. If your PX3 supports outlet-switching, you can turn on, off or power cycle an outlet. See Outlets.
Peripherals	Shows the information of connected Raritan environmental sensors or actuators, such as the temperature sensor. You can turn on or off a connected actuator with this command. See Peripherals (on page 104).
Assets	Shows the asset management information if Raritan asset management equipment is connected to your PX3. See Assets (on page 107).
Device Info	Shows the PX3 device's information, such as IP and MAC address. See Device Info (on page 111).

Note: To return to the automatic mode, press  . See **Automatic and Manual Modes** (on page 93).

Alerts

The "Alerts" menu command shows a list of the following alerted sensors, including both internal and external sensors.

- Any numeric sensor that enters the warning or critical range if the thresholds have been enabled
- State sensors that enter the alarmed state
- Any tripped circuit breakers or blown fuses

*Tip: The same information is available in the web interface's Dashboard. See **Dashboard - Alerted Sensors** (on page 140).*



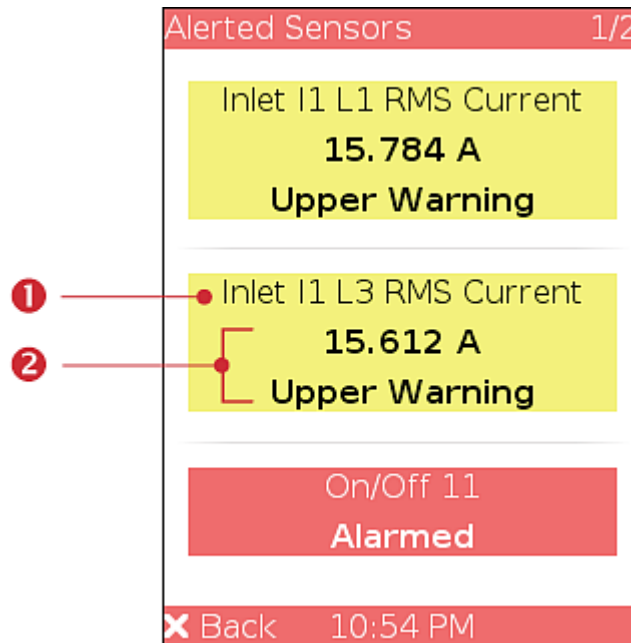

If there are no alerted sensors, the LCD display shows the message "No Alerts."

► **To view alerted sensors:**

1. Press / or / to select "Alerts" in the Main Menu, and press /.
2. Alerted sensors, if any, are highlighted in either red or yellow. For color definitions, see **Yellow- or Red-Highlighted Sensors** (on page 180).
 - The top and bottom bars on the LCD display may be yellow or red, depending on the type(s) of available alerts. See **Operating the Dot-Matrix LCD Display** (on page 95).



Number	Description
1	Sensor names.
2	<p>Sensor readings and/or states.</p> <p>A numeric sensor shows both the reading and state. A state sensor or actuator shows the state only.</p> <p>Available states are listed below. For further information, see <i>Sensor/Actuator States</i> (on page 182).</p> <ul style="list-style-type: none"> ▪ Alarmed ▪ Lower Critical = below lower critical ▪ Lower Warning = below lower warning ▪ Upper Warning = above upper warning ▪ Upper Critical = above upper critical ▪ Open (for overcurrent protectors)

3. Press / or / to view additional pages. When there are multiple pages, page numbers appear in the top-right corner of the display.







PDU

Depending on the model you purchased, the "PDU" menu command may show one or all of the following data.

- Internal beeper states -- On or Off
- Total active power of the PX3 -- available on multi-inlet models and in-line monitors only
- Total active energy of the PX3 -- available on multi-inlet models and in-line monitors only
- 12V power supply status -- available on iX7™ models only



*Tip: The internal beeper state information is also available in the PX3 web interface. See **PDU** (on page 145).*

► **To view or configure PDU information:**

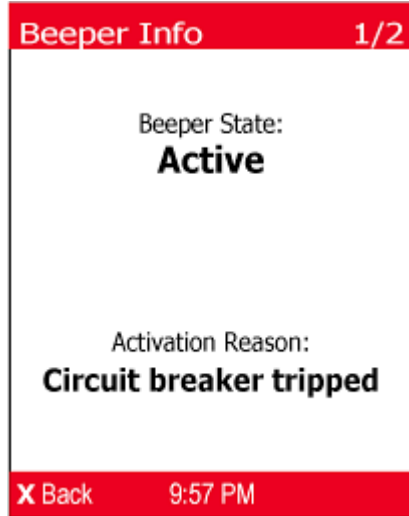

1. Press / or / to select "PDU" in the Main Menu, and press /.
2. The internal beeper state is shown: Active or Off.

- In the Active state, the reason of turning on the beeper is indicated, and the top/bottom bars turn red.



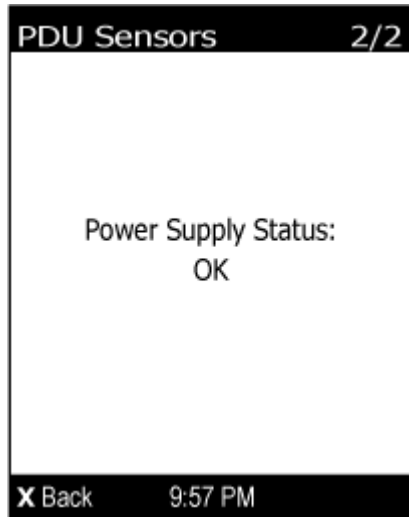

3. If your PDU is a PX3 with iX7™ controller, press / to show the status of the 12V power supply to the controller. For details on this sensor, see *+12V Power Supply Sensor (for iX7™ Only)* (on page 154).

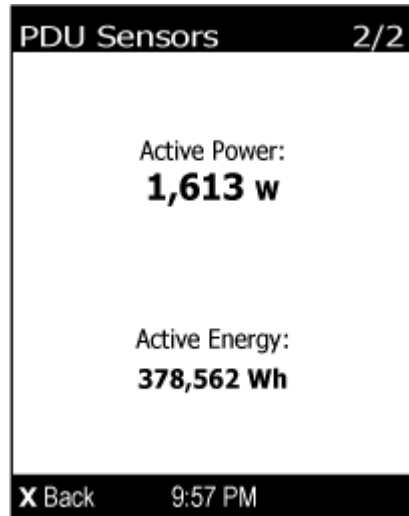

4. If your PX3 has more than one inlet, press / to show the information of total active power (W) and total active energy (Wh).









5. To return to the Main Menu, press /.

Inlet

An inlet's information is separated into two pages. Page numbers are indicated in the top-right corner of the LCD display.

► To show the inlet information:

1. Press / or / to select "Inlet I1" in the Main Menu, and press /.

- The first page shows the inlet's active power (W), apparent power (VA), power factor (PF), and active energy (Wh).

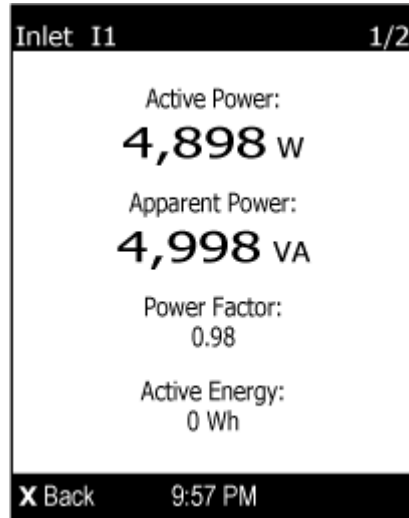

- To go to other page(s), press / or /.
 - For a single-phase model, the second page shows the inlet's voltage (V), frequency (Hz) and current (A).

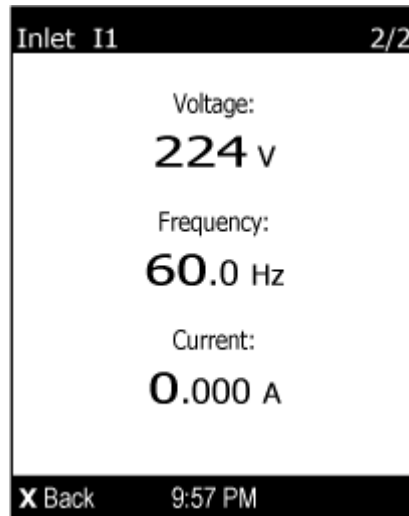



- For a three-phase model, the next several pages respectively show unbalanced current's percentage, line frequency, the current and voltage values of each line.
- To return to the Main Menu, press /.

OCPs



If your model has more overcurrent protectors (OCPs) than the LCD display can show at a time, a page number appears in the top-right corner of the display. Otherwise, no page numbers are available.

► **To show the overcurrent protector information:**

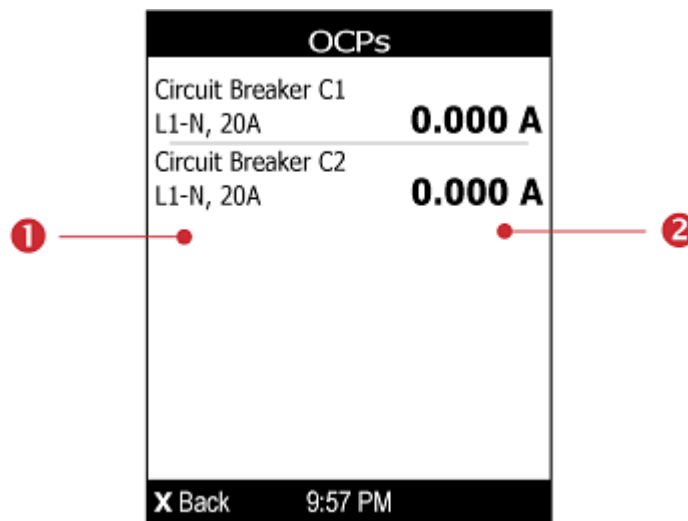
1. Press  or  to select "OCPs" in the Main Menu, and press .
2. The LCD display shows a list of overcurrent protectors similar to the following diagram.



Number	Description
①	Overcurrent protector names. Associated lines and rated current are displayed below each overcurrent protector's name.
②	Current reading of the corresponding overcurrent protector.

3. If the desired overcurrent protector is not visible, press  or  to scroll up or down.











Note: If any circuit breaker trips, the list of overcurrent protectors looks slightly different from the above diagram. The tripped one will show "open" instead of a current reading.

Peripherals

If there are no Raritan environmental sensor packages connected to your PX3, the LCD display shows the message "No managed devices" for the "Peripherals" menu command.

If you have enabled the front panel actuator control function, you can switch on or off a connected actuator using the LCD display. See *Miscellaneous* (on page 332).



► **To show environmental sensor or actuator information:**

1. Press / or / to select "Peripherals" in the Main Menu, and press /.
2. The display shows a list of environmental sensors/actuators similar to the following diagram.
 - If the desired sensor or actuator is not visible, press / or / to scroll up or down.
 - When the list exceeds one page, the currently-selected sensor/actuator's ID number and total of managed sensors/actuators are indicated in the top-right corner of the display.
 - If any sensor enters the warning, critical, or alarmed state, like 'Tamper Detector 1' shown below, it is highlighted in yellow or red. For color definitions, see *Yellow- or Red-Highlighted Sensors* (on page 180).

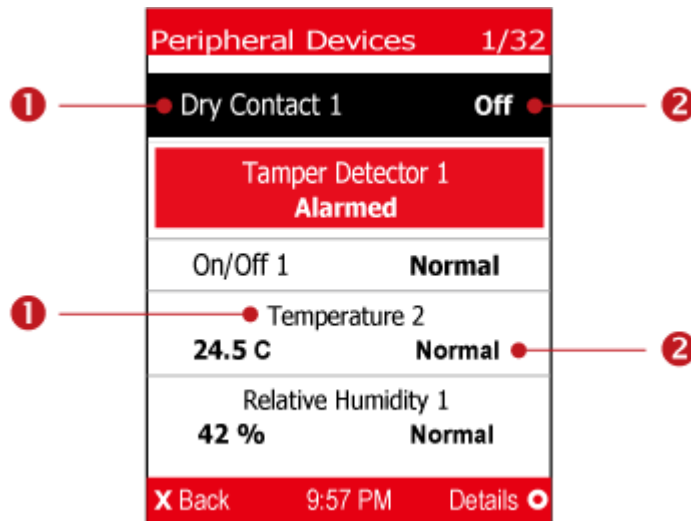
The top and bottom bars also turn yellow or red. See *Operating the Dot-Matrix LCD Display* (on page 95).



Number	Description
1	Sensor or actuator names.
2	<p>Sensor or actuator states as listed below. For further information, see <i>Sensor/Actuator States</i> (on page 182).</p> <ul style="list-style-type: none"> ▪ n/a = unavailable ▪ Normal ▪ Alarmed ▪ Lower Critical = below lower critical ▪ Lower Warning = below lower warning ▪ Upper Warning = above upper warning ▪ Upper Critical = above upper critical ▪ On ▪ Off <p>A numeric sensor shows both the reading and state. A state sensor or actuator shows the state only.</p>

3. To view an environmental sensor or actuator's detailed information, press  or  to select that sensor or actuator, and press . A screen similar to the following is shown.

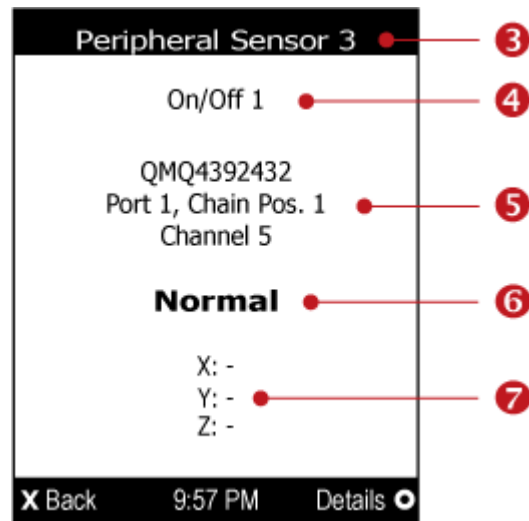



Number	Description
3	<p>The ID number assigned to this sensor or actuator.</p> <ul style="list-style-type: none"> ▪ A sensor shows "Peripheral Sensor x" (x is the ID number) ▪ An actuator shows "Peripheral Actuator x"

Number	Description
4	Sensor or actuator name.
5	<p>The following information is listed.</p> <ul style="list-style-type: none"> Serial number Chain position, which involves the following information: Port <N>: <N> is the number of the sensor port where this sensor or actuator is connected. This number is always 1 for PX3. Chain Pos. <n>: <n> is the sensor or actuator's position in a sensor daisy chain. <hr/> <p><i>Note: Only DX, DPX2 and DPX3 sensor packages provide the chain position information.</i></p> <hr/> <ul style="list-style-type: none"> If this sensor or actuator is on a sensor package with multiple channels, such as DX-D2C6, its channel number is indicated as "Channel x", where x is a number.
6	<p>Depending on the sensor type, any of the following information is displayed:</p> <ul style="list-style-type: none"> State of a state sensor: Normal or Alarmed. State of an actuator: On or Off. Reading of a numeric sensor.
7	X, Y, and Z coordinates which you specify for this sensor or actuator. See <i>Individual Sensor/Actuator Pages</i> (on page 188).



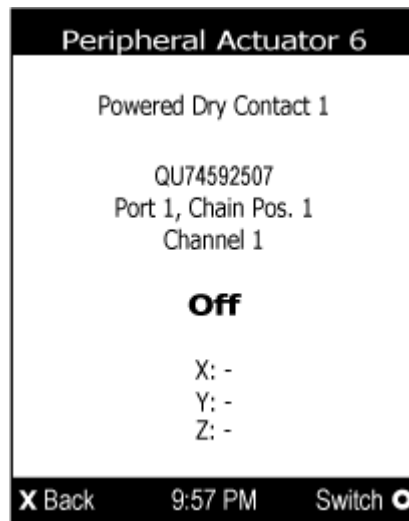

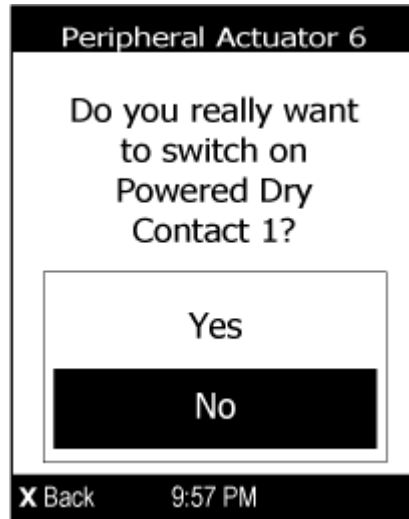

► **To switch on or off an actuator:**

1. Follow the above steps 1 to 3 to select an actuator.



- Press /  to turn on or off the actuator. A confirmation message similar to the following is shown.









- Press /  or /  to select Yes or No, and then press / .
- Verify that the actuator status shown on the LCD display has been changed.

Assets

If there are no Raritan asset management strips connected, the LCD display shows the message "No asset strips connected" for the "Assets" menu command.

After connecting asset strips, only the information of the rack units where asset tags have been detected are shown on the LCD display.

▶ To show asset strip information:

- Press /  or /  to select "Assets" in the Main Menu, and press / .
- The display shows the available asset strip, and indicates how many rack units and tags are detected on this strip.

- The number of tags includes both the tags attached to the asset strip and those attached to the blade extension strip, if any.







3. Press  to show this asset strip's details, including:
 - State - strip status.
 - Main Tags - number of the tags attached to the asset strip.
In the following diagram, this number is 30.
 - Blade Tags - number of the tags attached to the blade extension strip(s), if any.
In the following diagram, this number is 2.

Note: The 'Blade Tags' information appears only when there are tags detected on the connected blade extension strip.

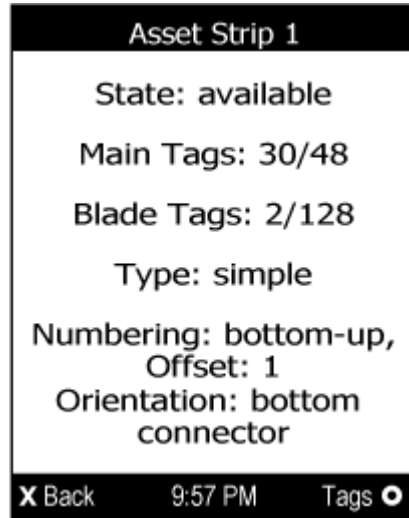
- Type - the asset strip type.
- Numbering - the numbering mode. See **Asset Strip** (on page 195).
- Offset - the starting number of the rack unit numbering.

- Orientation - the strip's orientation.



4. Press  again to show a list of available tags and their information.
 - When the list exceeds one page, the currently-selected main tag and total of available main tags are indicated in the top-right corner of the display.
 - If the desired tag is not visible, press  or  to scroll up or down.

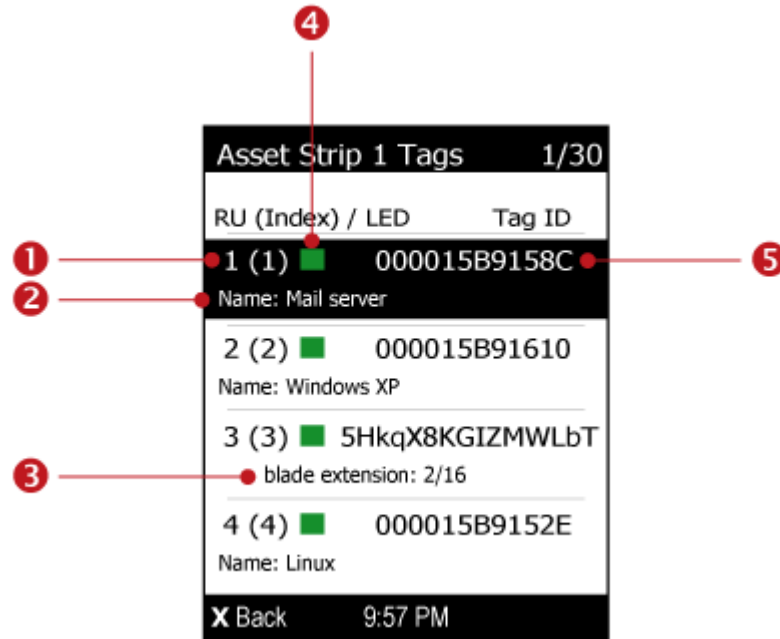

Number	Description
①	Two numbers are displayed for each tag. <ul style="list-style-type: none"> ▪ Rack unit number: The number assigned to this tag based on the selected numbering mode. See <i>Asset Strip</i> (on page 195). ▪ The index number in parentheses: The physical port number printed on the asset strip.
②	The asset tag's name if you have specified. This field does not show up when no name is available.
③	If the connected tag is the blade extension strip, it shows 'blade extension' and indicates how many tags and slots are available on this extension strip.
④	A color box, which represents the current LED color of the tag port where this asset tag is connected. The default is green. <ul style="list-style-type: none"> ▪ You can customize the color. See <i>Asset Strip</i> (on page 195).
⑤	The connected asset tag's ID number (barcode).

5. If any blade extension strip is connected to this asset strip, select it and Press  to view a list of available tags and asset IDs on this extension strip.



Number	Description
6	The information of the selected blade extension strip, including: <ul style="list-style-type: none"> ▪ Rack unit number ▪ Index number in parentheses ▪ Current LED color of the tag port where it is connected ▪ Extension strip's ID number (barcode)
7	The slot number of each asset tag
8	The connected asset tag's ID number (barcode).

Device Info

The display shows the device's information, network and IPv4/IPv6 settings through various pages. Page numbers are indicated in the top-right corner of the LCD display.

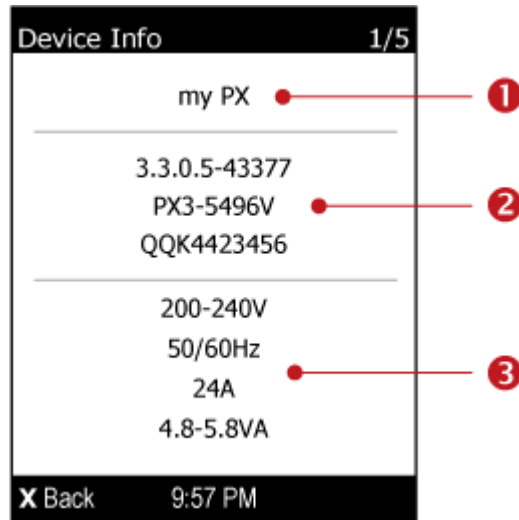

► **To show the device information:**

1. Press or to select "Device Info" in the Main Menu, and press .
2. Device information similar to the following diagram displays.





Number	Description
1	Device name.
2	Firmware version, model name and serial number.

Number	Description
3	Device ratings, including rated voltage, frequency, current and power.

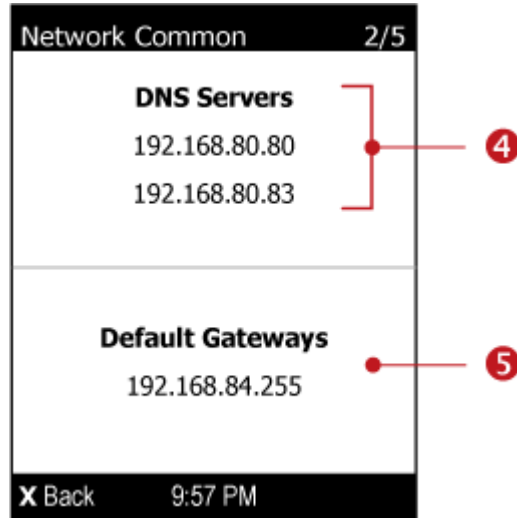
3. Press   to show the Network Common page.



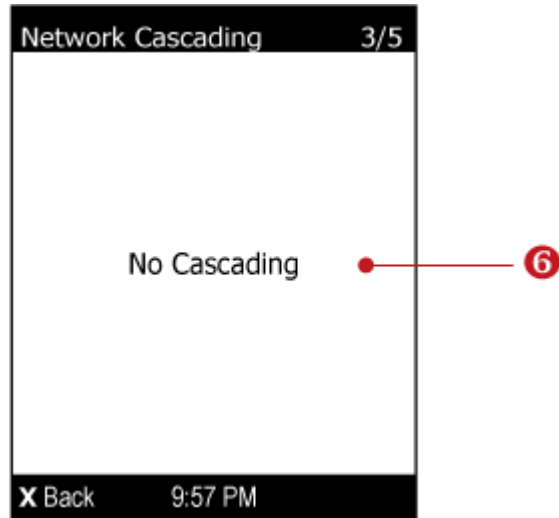

Number	Description
4	DNS servers.
5	Default gateways.

4. Press   to show the Network Cascading page.

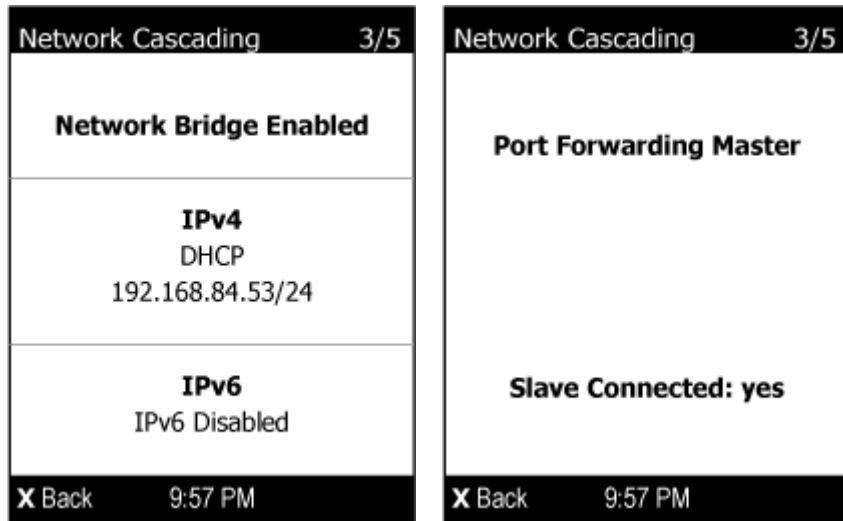



Number	Description
6	<p>Cascading status, which can be one of the following:</p> <ul style="list-style-type: none"> ▪ No Cascading: This device's cascading mode is set to None. See <i>Setting the Cascading Mode</i> (on page 231). ▪ Network Bridge Enabled: This device's cascading mode is set to Bridging. Its IP address is also displayed on this page. ▪ Port Forwarding Master: This device's cascading mode is set to Port Forwarding, and it is a master device. ▪ Port Forwarding Slave: This device's cascading mode is set to Port Forwarding, and it is a slave device. <ul style="list-style-type: none"> ▪ Slave Connected: Indicates whether the presence of a slave device is detected - <i>yes</i> or <i>no</i>. ▪ Cascade Position: Indicates the position of a slave device in the Port Forwarding mode. 1 represents Slave 1, 2 represents Slave 2, and so on. ▪ A port forwarding slave device will also display the master device's IP address on this page.

5. Press / to show the ETHERNET page.

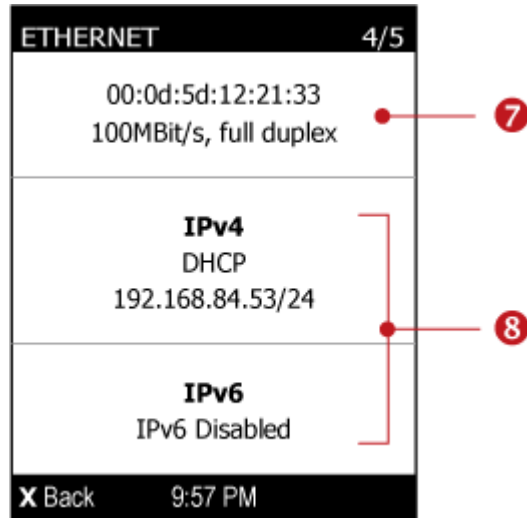

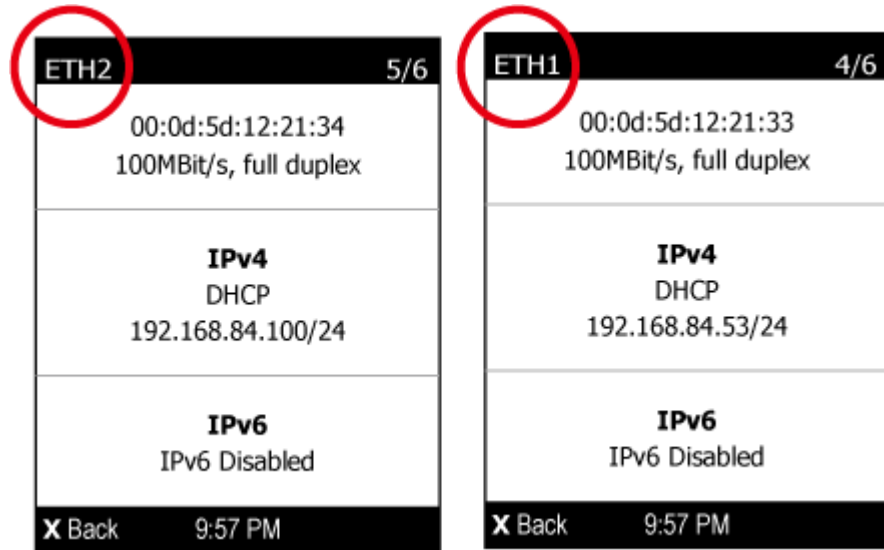

- For PX3-iX7 PDUs, there are two Ethernet pages -- ETH1 and ETH2.



Number	Description
7	Ethernet interface information, including: <ul style="list-style-type: none"> MAC address. Speed. Full or half duplex.

8	<p>IPv4/IPv6 network information, including:</p> <ul style="list-style-type: none"> ▪ Network configuration: DHCP (or Automatic), or Static. Static represents Static IP. ▪ IP address. ▪ Netmask or prefix length, such as "/24". <hr/> <p><i>Note: If you disable any Ethernet interface, a message 'Interface Disabled' is shown. See Ethernet Interface Settings (on page 221).</i></p>
----------	---

If you do not enable IPv4/IPv6 settings, an 'IPv4 (or IPv6) Disabled' message is displayed.

6. Press / to show the WIRELESS page.

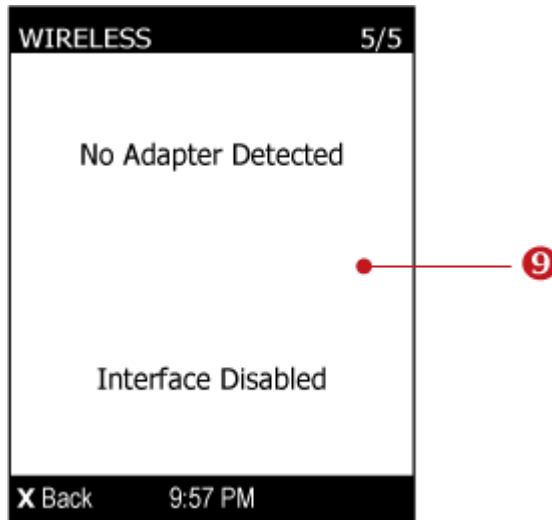

Number	Description
9	Wireless network information, if enabled, such as SSID.

7. To return to the Main Menu, press /.

Alerts Notice in a Yellow or Red Screen

In the automatic mode, if an alert occurs, the LCD display automatically shows a yellow or red screen which indicates the total number of alerted sensors and information of the latest transitions.





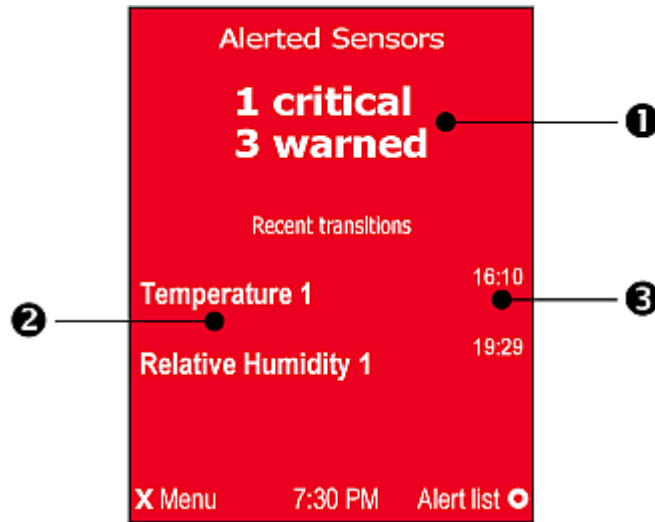



When all alerted sensors enter the warning levels, the screen's background is yellow. When any alerted sensor enters the critical level, the screen's background turns red. For additional information on colors, see *Yellow- or Red-Highlighted Sensors* (on page 180).

The following illustrates the alerts notice in the red screen.



Number	Description
①	The total of alerted sensors in the critical level and the total of those in the warning levels.
②	A list of final alerted sensors that changed their readings or states.
③	The final time that each alerted sensor changed its readings or states.

► Next steps:

- To view details of all alerted sensors, press /. If the detailed information exceeds one page, press / or / to switch between pages.
- To return to the Alerts Notice screen, press /.

Showing the Firmware Upgrade Progress

When upgrading the PX3, the firmware upgrade progress will be displayed as a percentage on the LCD display, similar to the following diagram.



In the end, a message appears, indicating whether the firmware upgrade is successful or fails.

Reset Button

The reset button is located inside the small hole near the display panel on the PDU.

The PX3 device can be reset to its factory default values using this button when a serial connection is available. See *Resetting to Factory Defaults* (on page 585).

Without the serial connection, pressing this reset button restarts the PX3 device's software without any loss of power to outlets.

The following images illustrate the locations of the reset button on Zero U models. Port locations may differ on your models.

► PX3 models:

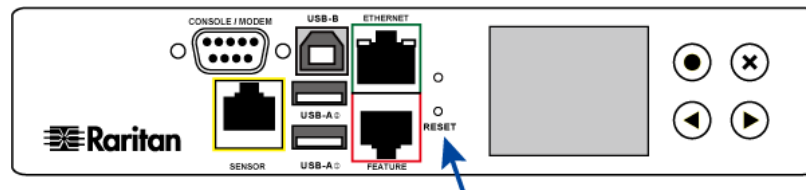

▶ **PX3-iX7 models:**

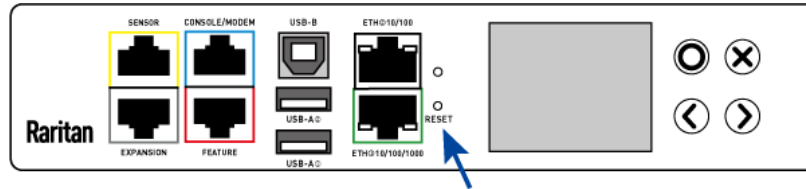

Circuit Breakers

PX3 models rated over 20A (North American) or 16A (international) contain overcurrent protectors for outlets, which are usually branch circuit breakers. These circuit breakers automatically trip (disconnect power) when the current flowing through the circuit breaker exceeds its rating.

If a circuit breaker switches off power, the LCD display shows *open*. To find which circuit breaker is open (trips), select Alerts or OCPs in the Main Menu. See *Operating the Dot-Matrix LCD Display* (on page 95).

When a circuit breaker trips, power flow ceases to all outlets connected to it. You must manually reset the circuit breaker so that affected outlets can resume normal operation.

Depending on the model you purchased, the circuit breaker may use a button- or handle-reset mechanism.

Resetting the Button-Type Circuit Breaker

Your button-type circuit breakers may look slightly different from the images shown in this section, but the reset procedure remains the same.

▶ **To reset the button-type breakers:**

1. Locate the breaker whose ON button is up, indicating that the breaker has tripped.

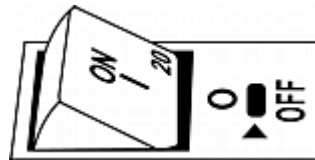

2. Examine your PX3 and the connected equipment to remove or resolve the cause that results in the overload or short circuit. **This step is required, or you cannot proceed with the next step.**

3. Press the ON button until it is completely down.



Resetting the Handle-Type Circuit Breaker

Your handle-type circuit breakers may look slightly different from the images shown in this section, but the reset procedure remains the same.

► **To reset the handle-type breakers:**

1. Lift the hinged cover over the breaker.
2. Check if the colorful rectangle or triangle below the operating handle is GREEN, indicating that the breaker has tripped.

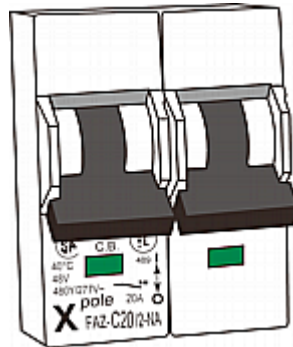

3. Examine your PX3 and the connected equipment to remove or resolve the cause that results in the overload or short circuit. **This step is required, or you cannot proceed with the next step.**
4. Pull up the operating handle until the colorful rectangle or triangle turns RED.

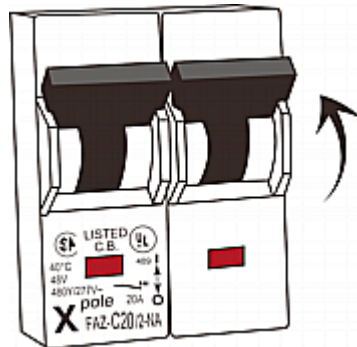

Fuse

Some PX3 devices may be implemented with fuses instead of circuit breakers. A fuse blows to protect associated outlets if it detects the overload.

If your PDU uses fuses, you must replace it with a new one when it blows or malfunctions. The rating of the new fuse must be the same as the original one.



Use of inappropriately rated fuse results in damage to the PDU and connected equipment, electric shock, fire, personal injury or death.

Depending on the design of your PDU, the fuse replacement methods differ.

Fuse Replacement on Zero U Models

This section only applies to a Zero U PDU with "replaceable" fuses.

► **To replace a fuse on Zero U models:**

1. Lift the hinged cover over the fuse.



2. Verify the new fuse's rating against the rating specified in the fuse holder's cover.



3. Push the cover of the fuse holder to expose the fuse.



4. Take the fuse out of the holder.



5. Insert a new fuse into the holder. There is no orientation limit for fuse insertion.
6. Close the fuse holder and the hinged cover in a reverse order.

Fuse Replacement on 1U Models

On the 1U model, a fuse is installed in a fuse knob, which fits into the PDU's fuse carrier.



Number	Description
①	Fuse carrier
②	Fuse knob where a fuse is installed

► **To replace a fuse on 1U PDUs:**

1. Disconnect the PDU's power cord from the power source.
2. Remove the desired fuse from the PDU's fuse carrier using a flat screwdriver.
 - a. Rotate the fuse knob counterclockwise until its slot is inclined to 45 degrees.

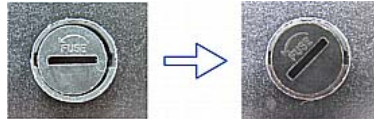

- b. Take this knob out of the fuse carrier.
3. Remove the original fuse from this knob, and insert either end of a new one into the knob. Make sure the new fuse's rating is the same as the original one.



Number	Description
①	Fuse knob
②	Fuse

- b. Gently push this knob into the fuse carrier and then rotate it clockwise until its slot is horizontal.
4. Install this knob along with the new fuse into the fuse carrier using a flat screwdriver.
 - a. Have this knob's slot inclined 45 degrees when inserting the knob into the fuse carrier.



- b. Gently push this knob into the fuse carrier and then rotate it clockwise until its slot is horizontal.

5. Verify whether this knob's head is aligned with the fuse carrier. If its head is higher or lower than the fuse carrier, re-install it.

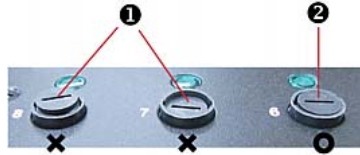

Number	Description
①	INAPPROPRIATE installations
②	Appropriate installation

6. Connect the PDU's power cord to the power source and verify that the corresponding fuse LED is lit, indicating that the fuse works properly.

Beeper

The PX3 includes an internal beeper to issue an audible alarm for an overcurrent protector which is open.

- The beeper sounds an alarm within 3 seconds of a circuit breaker trip.
- The beeper stops as soon as all circuit breakers have been reset.

You can also set the internal beeper to sound for specific events. See ***Event Rules and Actions*** (on page 272).

*Tip: To remotely check this beeper's state via the web interface, see **PDU** (on page 145).*

Replaceable Controller

A PX3 *Zero U* model provides flexibility for replacement of its controller. The controller, which contains the dot-matrix LCD display and connection ports, is usually located in the middle of the PDU.

If the controller is broken, you can simply send the controller back to Raritan for repair, or purchase a new controller from Raritan.

1U / 2U PDUs and all of PX3-3000 series do NOT support this feature.

► **To request a new controller:**

Contact tech@raritan.com to request a new PX3 controller.

Include these details with your request:

- The serial number of the PDU
- The serial number of the controller board
- The full model number of the PDU
- The firmware version that the PDU is running (if known).

► **To replace a controller:**

1. PDU is NOT required to be powered off.
2. Loosen the screws at two sides of the PX3 controller, and lift it up.

Note: Loosen the screws instead of removing them.

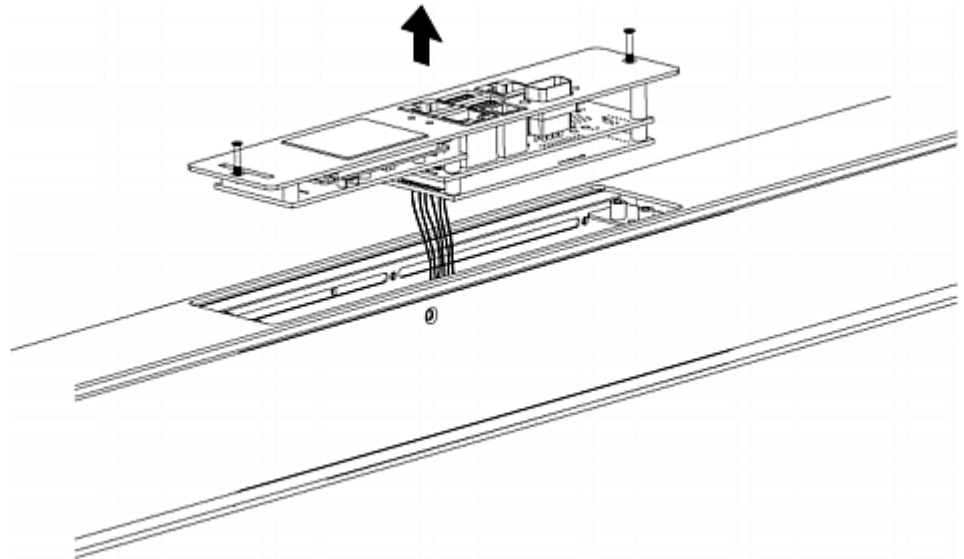

3. Disconnect the PDU's controller cable from the controller.

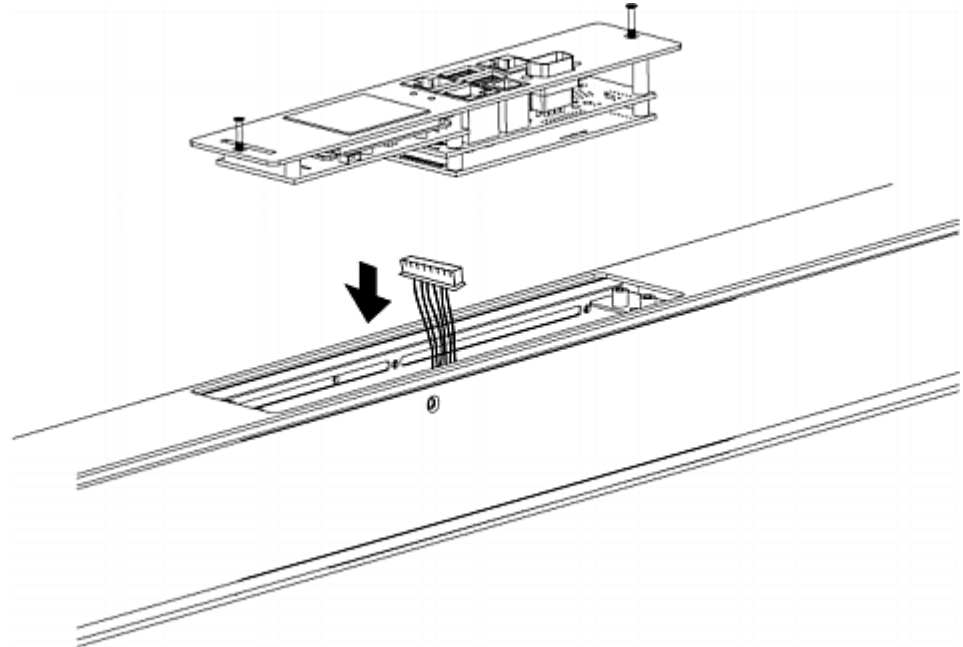

4. Get a new PX3 controller and install it back into the PDU in the reverse order.

Chapter 6 Using the Web Interface

This chapter explains how to use the web interface to administer a PX3.

In This Chapter

Supported Web Browsers	126
Login, Logout and Password Change	126
Web Interface Overview.....	129
Dashboard	135
PDU.....	145
Inlet.....	155
Outlets	158
OCPs	170
Peripherals.....	175
Feature Port	193
User Management.....	207
Device Settings.....	217
Maintenance	333
Webcam Management.....	352

Supported Web Browsers

- Internet Explorer® 11
- Windows Edge
- Firefox® 25 and later
- Safari® (Mac)
- Google® Chrome® 52 and later
- Android 4.2 and later
- iOS 7.0 and later

Note: Depending on the browser you use, spin controls similar to  may or may not appear in the numeric input fields. Clicking these adjusts numeric values by 1.

Login, Logout and Password Change

The first time you log in to the PX3, use the factory default "admin" user credentials. For details, see the Quick Setup Guide accompanying the product.

After login, you can create user accounts for other users. See ***Creating Users*** (on page 208).

Login

You must enable JavaScript in the web browser for proper operation.

► To log in to the web interface:

1. Open a browser and type the IP address of the PX3.
 - If the link-local addressing has been enabled, you can type *pdu.local* instead of an IP address. See **APIPA and Link-Local Addressing** (on page 3).



*Tip: You can also enter the desired page's URL so that you can immediately go to that page after login. See **Quick Access to a Specific Page** (on page 134).*

2. If any security alert message appears, accept it.
3. The login screen displays. Type your user name and password. User credentials are case sensitive.

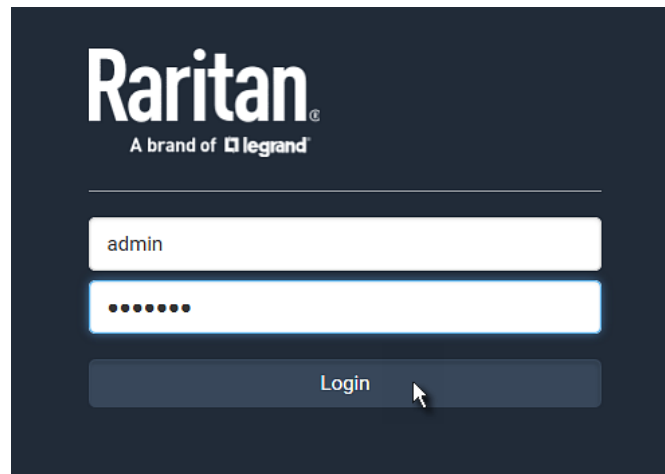

4. (Optional) If a security agreement is displayed, accept it. Otherwise, you cannot log in.
 - To select the agreement checkbox using the keyboard, first press Tab to go to the checkbox and then Enter.

*Note: To configure the security agreement, see **Enabling the Restricted Service Agreement** (on page 268).*

5. Click Login or press Enter. The PX3 web interface opens.

*Note: The address to access a slave device in the port forwarding mode via non-standard ports is a combination of a protocol (http:// or https://), an IP address and a port number. See **Port Forwarding Examples** (on page 236).*

Changing Your Password

You must have the Change Own Password permission to change your own password. See **Creating Roles** (on page 213).

You must have Administrator Privileges to change other users' passwords. See **Editing or Deleting Users** (on page 212).

► **Password change request on first login:**

On *first login*, if you have both the Change Local User Management and Change Security Settings permissions, you can choose to either change your password or ignore it.

- *Not Now* ignores the request for this time only.
- *Do not ask again* ignores the request permanently. If you select this checkbox, then click *Not Now*.
- Or enter the new password and click Ok.

Users without permissions listed must change password.

*Note: This password change request also appears if the 'force password change' is enabled in the user account setting. See **Creating Users** (on page 208).*

► **To change your password via the Change Password command:**

1. Choose User Management > Change Password.
2. First type the current password, and then the new password twice. Passwords are case sensitive.
 - A password comprises 4 to 64 characters.

Remembering User Names and Passwords

The PX3 supports the password manager of common web browsers, including:

- Microsoft Internet Explorer®
- Mozilla Firefox®
- Google Chrome®

You can save the login name and password when these browsers ask whether to remember them.

For information on how to activate a web browser's password manager, see the user documentation accompanying your browser.

The PX3 does NOT support other browser password managers.

Logout

After finishing your tasks, you should log out to prevent others from accessing the PX3 web interface.

▶ **To log out without closing the web browser:**

- Click "Logout" on the top-right corner.
-- OR --
- Close the PX3 tab while there are other tabs available in the browser.

▶ **To log out by closing the web browser:**

- Click  on the top-right corner of the window.
-- OR --
- Choose File > Close, or File > Exit.

Web Interface Overview

The web interface consists of four areas as shown below.

▶ **Operation:**

1. Click any menu or submenu item in the area of **1**.
2. That item's data/setup page is then opened in the area of **2**.
3. Now you can view or configure settings on the opened page.

- To return to the main menu and the Dashboard page, click



on the top-left corner.



Number	Web interface element
1	Menu (on page 132)
2	Data/setup page of the selected menu item
3	<ul style="list-style-type: none"> Left side: - PX3 device name

Number	Web interface element
	<p><i>Note: To customize the device name, see PDU (on page 145).</i></p> <ul style="list-style-type: none"> ▪ Right side: <ul style="list-style-type: none"> - Your login name, which you can click to view your user account settings - Logout button
4	<p>From top to bottom --</p> <ul style="list-style-type: none"> ▪ Your PX3 model ▪ Current firmware version ▪ Online Documentation: link to the PX3 online help. - See <i>Browsing through the Online Help</i> (on page 694). ▪ Raritan Support: link to the Raritan Technical Support webpage. ▪ Date and time of your user account's last login - Click Last Login to view your login history. ▪ PX3 system time - Click Device Time to open the Date/Time setup page.

Menu

Depending on your model and hardware configuration, your PX3 may show all or some menu items shown below.

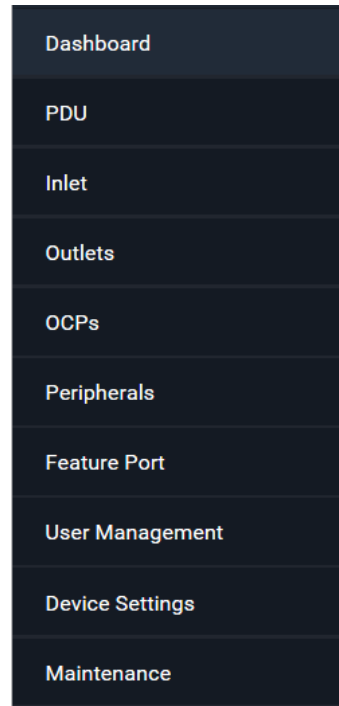



Menu	Information shown
Dashboard	Summary of the PX3 status, including a list of alerted sensors and alarms, if any. See <i>Dashboard</i> (on page 135).
PDU	Device data and settings, such as the device name and MAC address. See <i>PDU</i> (on page 145).
Inlet	Inlet status and settings, such as inlet thresholds. See <i>Inlet</i> (on page 155).
Outlets	Outlet status, settings and outlet control if your model is outlet-switching capable. See <i>Outlets</i> (on page 158).

Menu	Information shown
OCPs	<p>The OCPs menu item appears only when there are overcurrent protectors implemented on your model.</p> <p>OCP status and settings, such as OCP thresholds. See <i>OCPs</i> (on page 170).</p>
Peripherals	<p>Status and settings of Raritan environmental sensor packages, if connected. See <i>Peripherals</i> (on page 175).</p>
<p>Feature Port</p> <p>The name 'Feature Port(s)' will be replaced with one of the device names listed to the right</p>	<p>Status and settings of the device connected to the Feature port(s), which can be one of the following.</p> <ul style="list-style-type: none"> ▪ Asset Strip ▪ External Beeper ▪ LHX 20 ▪ SHX 30 ▪ LHX 40 ▪ Power CIM <p>See <i>Feature Port</i> (on page 193).</p>
Webcam, Webcam Snapshots	<p>The webcam-related menu items appear only when there are webcam(s) connected to the PX3.</p> <p>Webcam live snapshots/video and webcam settings. See <i>Webcam Management</i> (on page 352).</p>
User Management	<p>Data and settings of user accounts and groups, such as password change. See <i>User Management</i> (on page 207).</p>
Device Settings	<p>Device-related settings, including network, security, system time, event rules and more. See <i>Device Settings</i> (on page 217).</p>
Maintenance	<p>Device information and maintenance commands, such as firmware upgrade, device backup and reset. See <i>Maintenance</i> (on page 333).</p>

If a menu item contains the submenu, the submenu is shown after clicking that item.

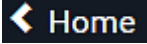
► **To return to the previous menu list, do any below:**

- Click the topmost link with the symbol >. For example, click 
- Press Backspace on the keyboard.
- OR click  on the top-left corner to return to the main menu.

Quick Access to a Specific Page

If you often visit a specific page in the PX3 web interface, you can note down its URL or bookmark it with your web browser. Next time, you can simply enter its URL in the address bar of the browser prior to login. After login, the PX3 immediately shows the desired page rather than the Dashboard page.

If needed, you can even send the URL to other users so that they can immediately see that page after login, using their own user credentials.

► **URL examples:**

In the following examples, it is assumed that the IP address of the PX3 is 192.168.84.118.

Page	URL
Peripherals	https://192.168.84.118/#/peripherals
Event Log	https://192.168.84.118/#/maintenance/eventLog/0

Sorting a List

If any list displays this arrow ▲ in one of its column headers, you are allowed to resort the list by clicking any column header. The list will be resorted in the ascending or descending order based on the selected column.

► **Example:**

1. By default, the Firmware Update History is sorted in the ascending order based on the Timestamp column. Therefore, the arrow ▲ is displayed adjacent to the Timestamp header.

- To have it resorted in the descending order based on the same column, click the Timestamp header.
- The arrow turns to ▼, indicating the list is sorted in the "descending" order.

Timestamp ▼

- To resort the list based on a different column, click a different column header.
- The arrow ▲ now appears adjacent to the selected column header, indicating the list is sorted in the ascending order based on that column.

Dashboard

The Dashboard page contains four to five sections, depending on your model.

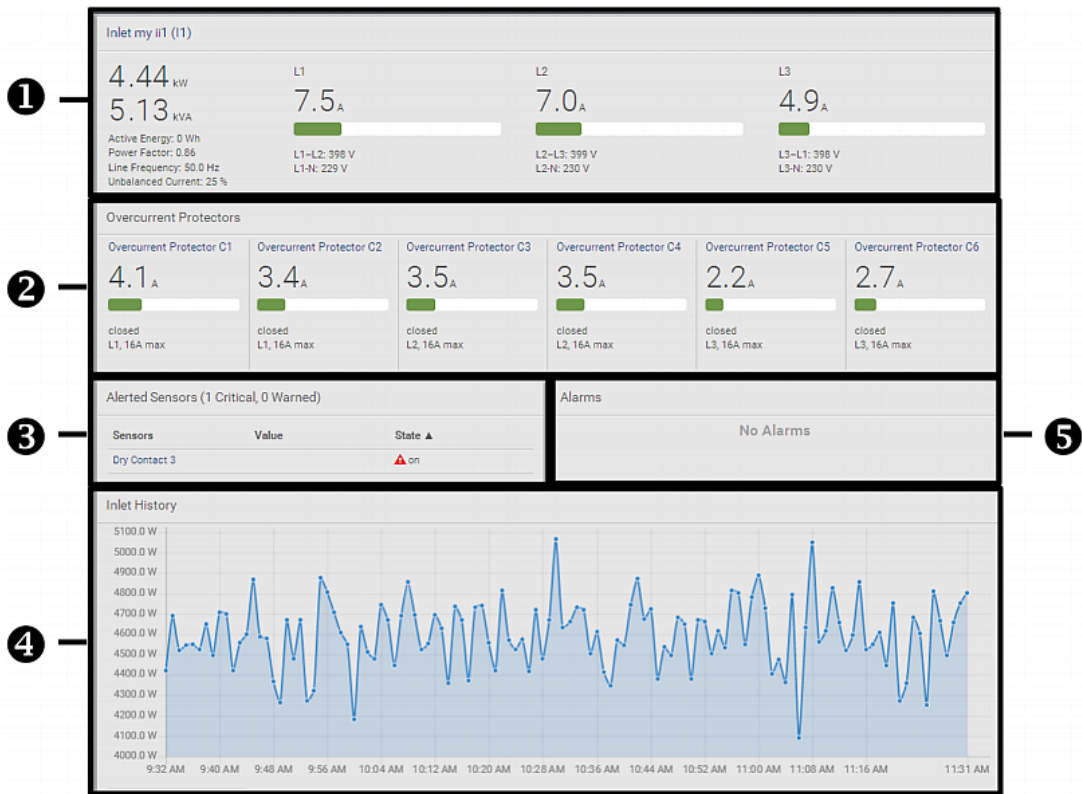

Number	Section	Information shown
1	Inlet I1	<ul style="list-style-type: none"> Overview of inlet power data A current bar per phase, which changes colors to indicate the RMS current state <ul style="list-style-type: none"> - green: normal - yellow: warning - red: critical <p>See <i>Dashboard - Inlet I1</i> (on page 137).</p>
2	Overcurrent Protectors	<p>This section is available only when your PX3 contains overcurrent protectors (OCPs).</p> <ul style="list-style-type: none"> Overview of each OCP's status A current bar per OCP, which changes colors to indicate the RMS current state <ul style="list-style-type: none"> - green: normal - yellow: warning - red: critical <p>See <i>Dashboard - OCP</i> (on page 139).</p>
3	Alerted Sensors	<ul style="list-style-type: none"> When no sensors enter the alarmed state, this section shows the message "No Alerted Sensors." When any sensor enters the alarmed state, this section lists all of them. <p>See <i>Dashboard - Alerted Sensors</i> (on page 140).</p>
4	Inlet History	<p>The waveform of the inlet's active power history is displayed by default. You can make it show a different data type.</p> <p>See <i>Dashboard - Inlet History</i> (on page 142).</p>
5	Alarms	<p>This section can show data only after you have set event rules requiring users to take the acknowledgment action.</p> <ul style="list-style-type: none"> When there are no unacknowledged events, this section shows the message "No Alarms." When there are unacknowledged events, this section lists all of them. <p>See <i>Dashboard - Alarms</i> (on page 143).</p>

Dashboard - Inlet I1

The number of phases shown in the Inlet section varies, depending on the model.

► [Link to the Inlet page:](#)

To view more information or configure the inlet(s), click this section's title 'Inlet I1' to go to the Inlet page. See *Inlet* (on page 155).

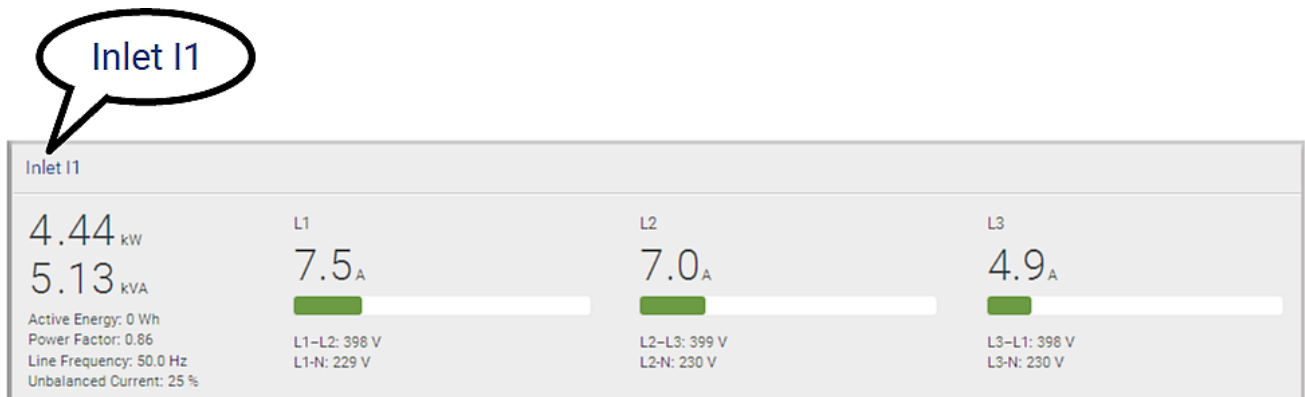

▶ **Left side - generic inlet power data:**

The left side lists all or some of the following data. Available data is model dependent.

- Active power (kW or W)
- Apparent power (kVA or VA)
- Active energy (kWh or Wh)
- Power factor
- Line frequency (Hz) - *model dependent*
- Unbalanced current (%) - *model dependent*



▶ **Right side - inlet's current and voltage:**

The right side shows the current and voltage data per phase. For a single-phase device, it shows only one line, but for a three-phase device, it shows three lines (L1, L2 and L3).

Inlet data from top to bottom includes:

- RMS current (A)
- A bar showing the RMS current level
- RMS voltage (V)

The RMS current bars automatically change colors to indicate the current status if the thresholds have been enabled. To configure thresholds, see *Inlet* (on page 155).

Status	Bar colors
normal	
above upper warning	
above upper critical	

Note: The "below lower warning" and "below lower critical" states also show yellow and red colors respectively. However, it is not meaningful to enable these two thresholds for current levels.

Dashboard - OCP

Availability and total number of OCPs depend on the models.

► **Each OCP's link:**

To view more information or configure individual OCPs, click the desired OCP's index number, which is C1, C2 and the like, to go to its setup page.

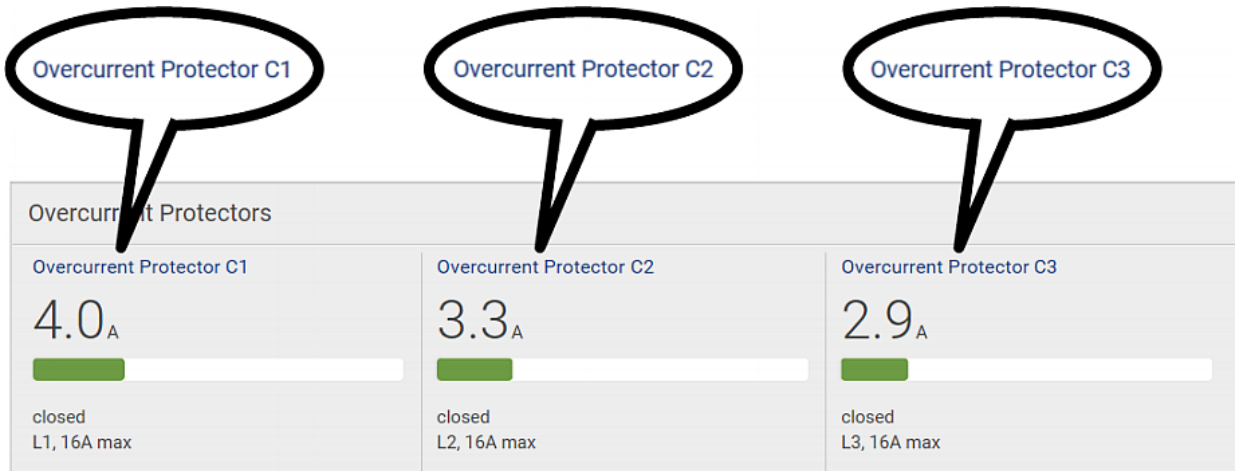



► **Each OCP's power data:**

OCP data from top to bottom includes:

- RMS current (A)
- A bar showing OCP current levels
- OCP status -- open or closed
- Associated line pair, and the OCP current rating (A)

The RMS current bars automatically change colors to indicate the current status if OCP thresholds have been enabled. To configure thresholds, see *OCPs* (on page 170).

Status	Bar colors
normal	
above upper warning	
above upper critical	

Note: The "below lower warning" and "below lower critical" states also show yellow and red colors respectively. However, it is not meaningful to enable these two thresholds for current levels.

Dashboard - Alerted Sensors

When any internal sensors or environmental sensor packages connected to the PX3 enter an abnormal state, the Alerted Sensors section in the Dashboard show them for alerting users. This section also lists tripped circuit breakers or blown fuses, if available.

To view detailed information or configure each alerted sensor, you can click each sensor's name to go to individual sensor pages. See *Individual Sensor/Actuator Pages* (on page 188).

If wanted, you can resort the list by clicking the desired column header. See *Sorting a List* (on page 134).

Alerted Sensors (1 Critical, 1 Warned)		
Sensors	Value	State ▲
Temperature 3	20.7 °C	▲ above upper critical
Temperature 1	19.8 °C	▲ above upper warning

► **Summary in the section title:**

Information in parentheses adjacent to the title is the total number of alerted sensors.



For example:

- **1 Critical:** 1 sensor enters the critical or alarmed state.
 - Numeric sensors enter the critical state.
 - State sensors enter the alarmed state.

- **1 Warned:** 1 'numeric' sensor enters the warning state.

► **List of alerted sensors:**

Two icons are used to indicate various sensor states.

Icons	Sensor states
	For numeric sensors: <ul style="list-style-type: none"> ▪ above upper warning ▪ below lower warning
	For numeric sensors: <ul style="list-style-type: none"> ▪ above upper critical ▪ below lower critical
	For state sensors: <ul style="list-style-type: none"> ▪ alarmed state

For details, see *Sensor/Actuator States* (on page 182).

Dashboard - Inlet History

The power waveform for the inlet helps you observe whether there were abnormal events within the past tens of minutes. The default is to show the inlet's active power data.

You can have it show the waveform of other inlet power data. Simply

select a different data type by clicking the selector  below the diagram. Available data types include:

- RMS current
- RMS voltage
- Active power
- Apparent power

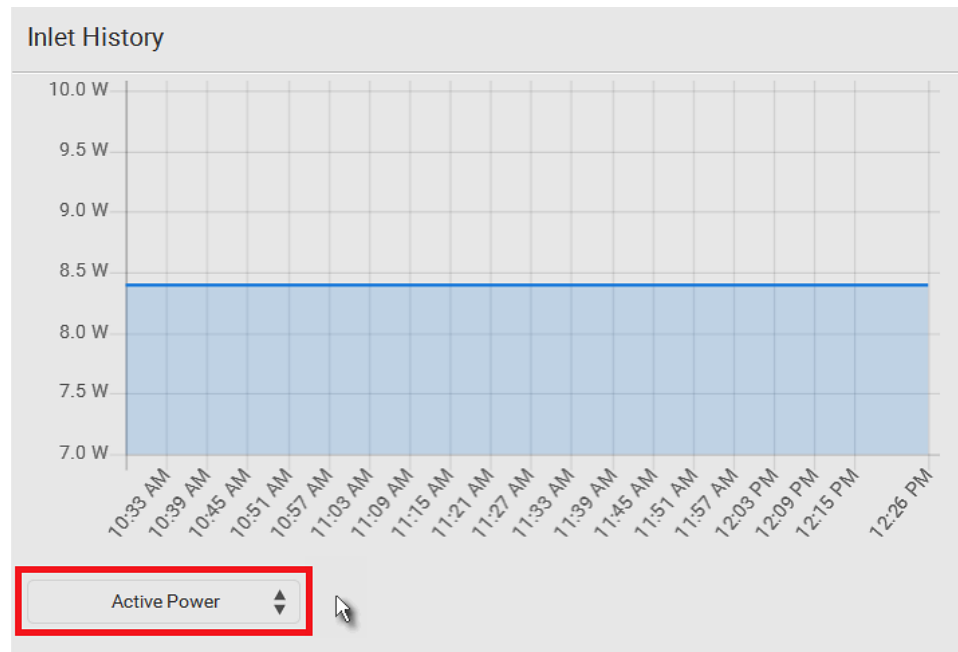

► **Inlet selection on multi-inlet models:**

If your PDU is a multi-inlet model, you can have one or multiple inlets show their power waveforms by selecting the checkbox(es) of the desired inlet(s).

- When multiple inlets are displayed, their waveform colors differ. You can identify each waveform according to the colors of the selected inlet checkboxes as illustrated below.



Dashboard - Alarms

If configuring any event rules which require users to take the acknowledgment action, the Alarms section will list any event which no one acknowledges yet since event occurrence.

*Note: For information on event rules, see **Event Rules and Actions** (on page 272).*

Only users with the Acknowledge Alarms permission can manually acknowledge an alarm.

► **To acknowledge an alarm:**

- Click Acknowledge, and that alarm then disappears from the Alarms section.

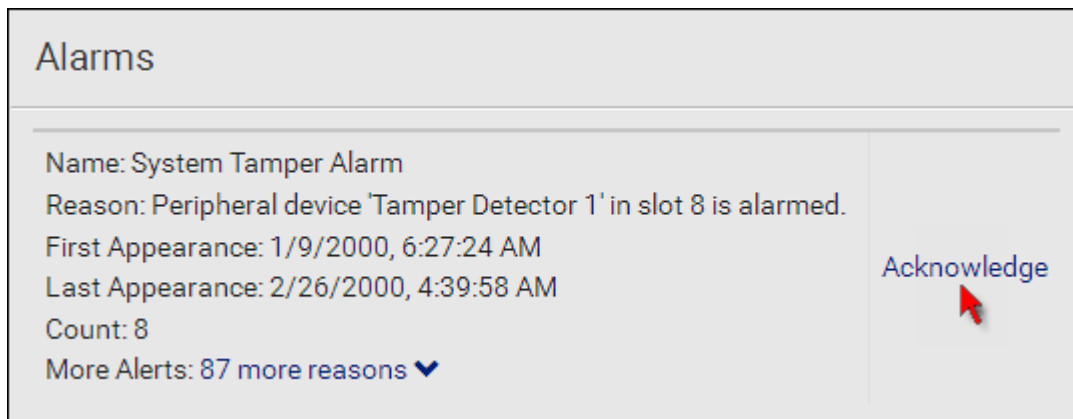

This table explains each column of the alarms list.

Field	Description
Name	The customized name of the Alarm action.
Reason	The first event that triggers the alert.
First Appearance	The date and time when the event indicated in the Reason column occurred for the first time.
Last Appearance	The date and time when the event indicated in the Reason column occurred for the last time.
Count	The number of times the event indicated in the Reason column has occurred.
More Alerts	<p>This field appears only when there are more than one type of events triggering this alert.</p> <p>If there are other types of events (that is, other reasons) triggering the same alert, the total number of additional reasons is displayed. You can click it to view a list of all events triggering this alert.</p>

PDU

The PX3 device's generic information and PDU-level global settings are available on the PDU page.

To open the PDU page, click 'PDU' in the **Menu** (on page 132).

▶ **Device information shown:**



- Firmware version
- Serial number
- MAC address
- Rating
- **Internal beeper state** (on page 148)
- Status of **+12V power supply sensor (for iX7[®] Only)** (on page 154)

▶ **To configure global settings:**

1. Click Edit Settings.

Settings		Edit Settings
Name	my PX	
Relay behavior on power loss	Non-latching	
Outlet state on device startup	last known	
Outlet initialization delay on device startup	3 s	
Power off period during power cycle	10 s	
Inrush Guard Delay	200 ms	
Peripheral Device Z Coordinate Format	Rack-Units	
Peripheral Device Auto Management	enabled	
Altitude	0 m	
Reset All Active Energy Counters	<input type="button" value="Reset Active Energy"/>	

2. Now you can configure the fields.

- Click  to select an option.
- Select or deselect the checkbox.
- Adjust the numeric values.
- For time-related fields, if option selection using  is not preferred, the value must include a time unit, such as '50 s'. See **Time Units** (on page 153).

*In the following table, those fields marked with * are available on an outlet-switching capable model only.*

Field	Function	Note
Name	Customizes the device name.	
*Relay behavior on power loss	<p>Selects an operating mode to determine the latching relay behavior when PDU power is lost.</p> <ul style="list-style-type: none"> Options: <i>Non-latching and Latching</i> <i>Non-latching has all relays open at the power loss while latching may have the relays closed.</i> 	See PX3 Latching Relay Behavior (on page 150).
*Outlet state on device startup	<p>Determines the initial power state of ALL outlets after the PX3 device powers up.</p> <ul style="list-style-type: none"> Options: <i>on, off, and last known</i> <p>See Options for Outlet State on Startup (on page 150).</p>	<ul style="list-style-type: none"> After removing power from the PDU, you must wait for a minimum of 10 seconds before powering it up again. Otherwise, the default outlet state settings may not work properly. You can override the global outlet state setting on a per-outlet basis so specific outlets behave differently on startup. See Individual Outlet Pages (on page 165).
*Outlet initialization delay on device startup	<p>Determines how long the PX3 device waits before providing power to all outlets during power cycling or after recovering from a temporary power loss.</p> <ul style="list-style-type: none"> Range: <i>1 second to 1 hour</i> 	See Initialization Delay Use Cases (on page 151).
*Power off period during power cycle	<p>Determines the power-off period after the outlet is switched OFF during a power cycle.</p> <ul style="list-style-type: none"> Range: <i>1 second to 1 hour</i> 	<ul style="list-style-type: none"> Power cycling the outlet(s) turns the outlet(s) off and then back on. You can override this global power cycle setting on a per-outlet basis so specific outlets' power-off period is different. See Individual Outlet Pages (on page 165).

Field	Function	Note
*Inrush Guard Delay	Prevents a circuit breaker trip due to inrush current when many devices connected to the PDU are turned on. <ul style="list-style-type: none"> ▪ <i>Range: 100 milliseconds to 2 seconds</i> 	See <i>Inrush Current and Inrush Guard Delay</i> (on page 151).
Peripheral Device Z Coordinate Format	Determines how to describe the vertical locations (Z coordinates) of Raritan environmental sensor packages. <ul style="list-style-type: none"> ▪ <i>Options: Rack-Units and Free-Form</i> See <i>Z Coordinate Format</i> (on page 152).	To specify the location of any sensor/actuators in the data center, see <i>Individual Sensor/Actuator Pages</i> (on page 188).
Peripheral Device Auto Management	Enables or disables the automatic management feature for Raritan environmental sensor packages. <ul style="list-style-type: none"> ▪ <i>The default is to enable it.</i> 	See <i>How the Automatic Management Function Works</i> (on page 152).
Altitude	Specifies the PX3 device's altitude above sea level when a Raritan's DPX differential air pressure sensor is attached. <ul style="list-style-type: none"> ▪ <i>Range: 0 to 3000 meters (0 to 9842 feet)</i> 	<ul style="list-style-type: none"> ▪ The device's altitude is associated with the altitude correction factor. See <i>Altitude Correction Factors</i> (on page 684). ▪ The default altitude measurement unit is meter. See <i>Setting Default Measurement Units</i> (on page 216). ▪ You can have the measurement unit vary between meter and foot according to user credentials. See <i>Setting Your Preferred Measurement Units</i> (on page 215).

3. Click Save.

► **To reset ALL active energy counters:**

An active energy reading is a value of total accumulated energy, which is never reset, even if the power fails or the PX3 is reset. However, you can manually reset this reading to restart the energy accumulation process.

Only users with the "Admin" role assigned can reset active energy readings.

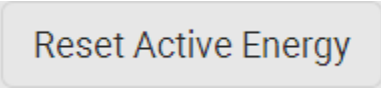

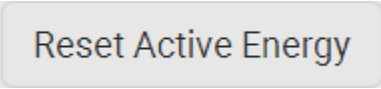
1. Click .
2. Click Reset on the confirmation message.
 - All active energy readings on this PX3 are reset to zero.

*Tip: You can choose to reset the active energy reading of an individual inlet only. See **Inlet** (on page 155).*

► **To view total active energy and power on multi-inlet models:**

If your PX3 is a multi-inlet model, a "Power" section for showing the data of total active energy and total active power is available on the PDU page.

For a regular PX3 model with multiple inlets:

- Total active energy = sum of all inlets' active energy values
- Total active power = sum of all inlets' active power values

Sensor	Value	State
Active Power	16 W	normal
Active Energy	100243 Wh	normal

Figure 1: i

► **To configure the thresholds of total active energy and power:**

For a multi-inlet model or an in-line monitor, a "Thresholds" section is available on the PDU page. See **Setting Thresholds for Total Active Energy or Power** (on page 153).



Internal Beeper State

The PDU page indicates the internal beeper state.

Internal Beeper	
State	Off

► **Available beeper states:**

States	Description
Off	The beeper is turned off.
Active	<p>The beeper is turned on.</p> <p>"Activation Reason" is displayed, indicating why the beeper sounds an alarm.</p> <p>For example, if the beeper is turned on because of a specific event rule "XXX," the activation reason looks like:</p> <p>Event Action triggered by rule: XXX</p>

► **Scenarios when the beeper sounds an alarm:**

- Any overcurrent protector on the PX3, including fuses and circuit breakers, has tripped or blown. See *Beeper* (on page 123).
- You have set an event rule that turns on the internal beeper when a specific event occurs, and that event occurs. See *Event Rules and Actions* (on page 272).
- On the PX3 supporting residual current monitoring (RCM), the beeper also sounds when there is an RCM alarm. See *PX3 Models with Residual Current Monitoring* (on page 588).

*Tip: To check the internal beeper state via CLI, see **PDU Configuration** (on page 375).*

PX3 Latching Relay Behavior

PX3 incorporates latching relays in models with outlet switching. Unlike non-latching relays, latching relays do NOT require power to keep their contacts closed.

PX3 outlet switching can be configured to operate as a true latching relay or to simulate a non-latching relay. The operating mode determines the latching relay behavior when PDU power is lost. Regardless of which mode is selected, power is not required to keep relay contacts closed.

▶ **Non-Latching Mode:**

- Relay always opens when power is lost. This insures all relays are open when power is applied to the PDU.
- Always select this mode if the combined in-rush current of the devices connected to the PDU trip circuit breakers when power is applied to the PDU.
- This is the factory default operating mode.

▶ **Latching Mode:**

- Relay does not open when power is lost.
- This is the preferred operating mode ONLY if you are sure in-rush current does not trip circuit breakers when power is applied to the PDU.
- Power to the outlet is not disrupted if a PDU internal failure occurs.
- In Latching mode, the following features are disabled.
 - PDU-level outlet state on startup: See *PDU* (on page 145).
 - Outlet-level outlet state on startup: See *Individual Outlet Pages* (on page 165).
 - PDU-level outlet initialization delay on startup: See *PDU* (on page 145).

Options for Outlet State on Startup

The following are available options for initial power states of outlets after powering up the PX3 device.

Option	Function
on	Turns on the outlet(s).
off	Turns off the outlet(s).
last known	Restores the outlet(s) to the previous power state(s) before the PX3 was powered off.

If you are configuring an individual outlet on *Individual Outlet Pages* (on page 165), there is one more outlet state option.

Additional option	Function
PDU defined (xxx)	<p>Follows the global outlet state setting, which is set on <i>PDU</i> (on page 145).</p> <p>The value xxx in parentheses is the currently-selected global option - on, off, or last known.</p>

Initialization Delay Use Cases

Apply the initialization delay in either of the following scenarios.

- When power may not initially be stable after being restored
- When UPS batteries may be charging

▶ **Tip:**

When there are a large number of outlets, set the value to a lower number so that you can avoid a long wait before all outlets are available.

Inrush Current and Inrush Guard Delay

▶ **Inrush current:**

When electrical devices are turned on, they can initially draw a very large current known as inrush current. Inrush current typically lasts for 20-40 milliseconds.

▶ **Inrush guard delay:**

The inrush guard delay feature helps prevent a circuit breaker trip due to the combined inrush current of many devices turned on at the same time.

For example, if the inrush guard delay is set to 100 milliseconds and two or more outlets are turned on at the same time, the PDU will sequentially turn the outlets on with a 100 millisecond delay occurring between each one.

Z Coordinate Format

You can use either the number of rack units or a descriptive text to describe the vertical locations (Z coordinates) of environmental sensors and actuators, which are configured on the *Individual Sensor/Actuator Pages* (on page 188).

The Z coordinate format is determined on *PDU* (on page 145). For a Z coordinate example, see *Sensor/Actuator Location Example* (on page 192).

▶ **Available Z coordinate formats:**

- **Rack Units:** The height of the Z coordinate is measured in standard rack units. When this is selected, you can type a numeric value in the rack unit to describe the Z coordinate of any environmental sensors or actuators.
- **Free-Form:** Any alphanumeric string can be used for specifying the Z coordinate. The value can be 0 to 24 characters long.

How the Automatic Management Function Works

This setting is configured on *PDU* (on page 145).

▶ **After enabling the automatic management function:**

When the total number of managed sensors and actuators has not reached the upper limit yet, the PX3 automatically brings newly-connected environmental sensors and actuators under management after detecting them.

A PX3 can manage up to 32 sensors/actuators.

▶ **After disabling the automatic management function:**

The PX3 no longer automatically manages any newly-added environmental sensors and actuators, and therefore neither ID numbers are assigned nor sensor readings or states are available for newly-added ones.

You must manually manage new sensors/actuators. See *Peripherals* (on page 175).

Time Units

If you choose to type a new value in the time-related fields, such as the Inrush Guard Delay field, you must add a time unit after the numeric value. For example, you can type '15 s' for 15 seconds.

Note that different fields have different range of valid values.

▶ Time units:

Unit	Time
ms	millisecond(s)
s	second(s)
min	minute(s)
h	hour(s)
d	day(s)

Setting Thresholds for Total Active Energy or Power

This section applies only to multi-inlet models, including in-line monitors.

Thresholds for total active energy and total active power are disabled by default. You can enable and set them so that you are alerted when the total active energy or total active power hits a certain level.

For a regular PX3 model with multiple inlets:

- Total active energy = sum of all inlets' active energy values
- Total active power = sum of all inlets' active power values

For an in-line monitor with multiple inlets/outlets:

- Total active energy = sum of all outlets' active energy values
- Total active power = sum of all outlets' active power values

▶ To configure thresholds for total active energy and/or power:

1. Click PDU.
 - On the PDU page, you can also view the total active power and total active energy. See *PDU* (on page 145).

- Click the Thresholds title bar at the bottom of the page to display thresholds.



- Click the desired sensor (required), and then click Edit Thresholds.

Thresholds				
				Edit Thresholds
Sensor ▲	Lower Critical	Lower Warning	Upper Warning	Upper Critical
Active Energy	---	---	---	---
Active Power	---	---	---	---

- Make changes as needed.
 - To enable any threshold, select the corresponding checkbox.
 - Type a new value in the accompanying text box.

*For concepts of thresholds, deassertion hysteresis and assertion timeout, see **Sensor Threshold Settings** (on page 675).*

- Click Save.

+12V Power Supply Sensor (for iX7™ Only)

An iX7™ PDU's controller receives DC 12V power from its inlet. A sensor monitors the power supply status and indicates it on the PDU page.

Sensors		
Sensor	Value	State
+12V Supply 1 Status		OK

State	Description
OK	The iX7™ controller is receiving power from its inlet.

State	Description
fault	The iX7™ controller cannot receive power from its inlet because of a power failure on the inlet or a broken 12V power supply. Instead it receives power from another iX7™ PDU. See <i>Power-Sharing Restrictions and Connection (for iX7™ Only)</i> (on page 47). After entering the fault state, this sensor is listed in the Alerted Sensors section of the Dashboard. See <i>Dashboard</i> (on page 135).
unavailable	The communication with the 12V power supply sensor is lost.

► **Alternatives for checking the 12V power supply status:**

- Dot-matrix LCD panel. See *PDU* (on page 99).
- CLI command: `show pdu details`. See *Using the Command Line Interface* (on page 365).

Inlet

You can view all inlet information, configure inlet-related settings, or reset the inlet active energy on the Inlet page. To open this page, click 'Inlet' in the *Menu* (on page 132).

Inlet thresholds, when enabled, help you identify whether the inlet enters the warning or critical level. In addition, you can have the PX3 automatically generate alert notifications for any warning or critical status. See *Event Rules and Actions* (on page 272).

*Note: If your PX3 is a multi-inlet model, see **Configuring a Multi-Inlet Model** (on page 157).*

► **Generic inlet information shown:**

- Inlet power overview, which is the same as *Dashboard - Inlet I1* (on page 137).
- A list of inlet sensors with more details. Number of available inlet sensors depends on the model.
 - Sensors show both readings and states.
 - Sensors in warning or critical states are highlighted in yellow or red.

See *Yellow- or Red-Highlighted Sensors* (on page 180).

- Inlet's power waveform, which is the same as *Dashboard - Inlet History* (on page 142)

► **To customize the inlet's name:**

1. Click Edit Settings.



2. Type a name for the inlet.
 - For example, you can name it to identify the power source.
3. Click Save.
4. The inlet's custom name is displayed on the Inlet or Dashboard page, followed by its label in parentheses.

► **To reset the inlet's active energy counter:**

Only users with the "Admin" role assigned can reset active energy readings.

The energy reset feature per inlet is especially useful when your PX3 has more than one inlet.

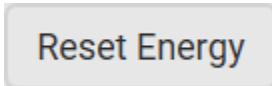

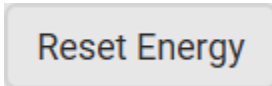
1. Click .
2. Click Reset on the confirmation message.

This inlet's active energy reading is then reset to zero.

*Tip: To reset ALL active energy counters on the PX3, see **PDU** (on page 145).*

► **To configure inlet thresholds:**

1. Click the Thresholds title bar at the bottom of the page to display inlet thresholds.



2. Click the desired sensor (required), and then click Edit Thresholds.

Thresholds				
Edit Thresholds				
Sensor ▲	Lower Critical	Lower Warning	Upper Warning	Upper Critical
Active Energy	---	---	---	---
Active Power	---	---	---	---
Apparent Power	---	---	---	---
Line Frequency	57 Hz	59 Hz	61 Hz	63 Hz
Power Factor	---	---	---	---
RMS Current	---	---	5 A	10 A
RMS Voltage	160 V	180 V	240 V	250 V

3. Make changes as needed.
 - To enable any threshold, select the corresponding checkbox.
 - Type a new value in the accompanying text box.

For concepts of thresholds, deassertion hysteresis and assertion timeout, see *Sensor Threshold Settings* (on page 675).

4. Click Save.

► **To configure residual current thresholds:**

If your model supports residual current monitoring, a section titled "Residual Current Monitor" is displayed on the Inlet page. See *Web Interface Operations for RCM* (on page 591).

Configuring a Multi-Inlet Model

If the PX3 has more than one inlet, the Inlets page lists all inlets.

► **To view or configure each inlet:**

1. Click 'Show Details' of the desired inlet.
2. Now you can configure the selected inlet, such as enabling thresholds or resetting its energy. See *Inlet* (on page 155).
 - To disable the inlet, see the following instructions.

► **To disable one or multiple inlets:**

1. On the individual inlet's data page, click Edit Settings.
2. Select the "Disable this inlet" checkbox.
3. Click Save.
4. The inlet status now shows "Disabled."
5. To disable additional inlets, repeat the above steps.

- If disabling an inlet will result in all inlets being disabled, a confirmation dialog appears, indicating that all inlets will be disabled. Then click Yes to confirm this operation or No to abort it.

After disabling any inlet, the following information or features associated with the disabled one are no longer available:

- Sensor readings, states, warnings, alarms or event notifications associated with the disabled inlet.
- Sensor readings, states, warnings, alarms or event notifications for all outlets and overcurrent protectors associated with the disabled inlet.
- The outlet-switching capability, if available, for all outlets associated with the disabled inlet.

Exception: All active energy sensors continue to accumulate data regardless of whether any inlet has been disabled.

Warning: A disabled inlet, if remaining connected to a power source, continues to receive power from the connected power source and supplies power to the associated outlets and overcurrent protectors.

Outlets

The Outlets page shows a list of all outlets and the overview of outlet status and readings. To open this page, click 'Outlets' in the **Menu** (on page 132).

On this page, you can:

- **View all outlets' status.**

If any outlet sensor enters the alarmed state, it is highlighted in yellow or red. See **Yellow- or Red-Highlighted Sensors** (on page 180).

- Perform actions on all or multiple outlets simultaneously by using the setup/power-control icons on the top-right corner.
Note that only outlet-switching capable models show the power-control buttons, and you must have the Switch Outlet permission for performing outlet-switching operations. PX3-1000 series does not have power-control buttons.

Outlets				
# ▲	Name	Status	Receptacle Type	Lines
1	Outlet 1	on	IEC 60320 C13	L1-NEUTRAL
2	Outlet 2	on	IEC 60320 C13	L1-NEUTRAL
3	Outlet 3	on	IEC 60320 C13	L1-NEUTRAL
4	Outlet 4	on	IEC 60320 C13	L1-NEUTRAL
5	Outlet 5	on	IEC 60320 C13	L1-NEUTRAL

- Go to an individual outlet's data/setup page by clicking an outlet's name. See *Individual Outlet Pages* (on page 165).

Outlets	
# ▲	Name
1	Outlet 1
2	Outlet 2
3	Outlet 3
4	Outlet 4

If wanted, you can resort the list by clicking the desired column header. See *Sorting a List* (on page 134).

► To show or hide specific columns on the outlets overview page:

1. Click  to show a list of outlet data types.
2. Select those you want to show, and deselect those you want to hide. See *Available Data of the Outlets Overview Page* (on page 162).

PX3-1000 series does NOT support the following features.

► **To configure global outlet settings or perform the load-shedding command:**

1. Click  to show a list of commands.
2. Select the desired command. Note that only outlet-switching capable models show the commands marked with * in the table.

Command	Refer to
*Sequence Setup	<i>Setting Outlet Power-On Sequence and Delay</i> (on page 162)
*Load Shedding Setup	<i>Setting Non-Critical Outlets</i> (on page 163)
*Activate Load Shedding -- OR-- *Deactivate Load Shedding	<i>Load Shedding Mode</i> (on page 164)



► **To power control multiple outlets:**

You can switch any outlet regardless of its current power state. That is, you can turn on any outlet that is already turned on, or turn off any outlet that is already turned off.

1. Click  to make checkboxes appear in front of outlets.

Tip: To perform the desired action on only one outlet, you can simply click that outlet without making the checkboxes appear.

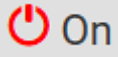
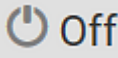
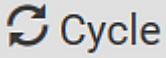
2. Select multiple outlets.
 - To select ALL outlets, select the topmost checkbox in the header row.
3. Click or select the desired button or command.

Button/command	Action
 On	Power ON.
 Off	Power OFF.
 Cycle	Power cycle. <ul style="list-style-type: none"> Power cycling the outlet(s) turns the outlet(s) off and then back on.
 > Reset Active Energy	Resets active energy readings of selected outlets. <ul style="list-style-type: none"> Only users with the "Admin" role assigned can reset active energy readings.

- Confirm the operation on the confirmation message.

*Tip: To reset ALL active energy counters on the PX3, see **PDU** (on page 145). You can also power control an outlet from **Individual Outlet Pages** (on page 165).*

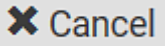
- When "multiple" outlets are involved in an outlet-switching operation, a 'Sequence running' message similar to the following displays before the outlet-switching process finishes.
 - It indicates how many selected outlets are NOT switched on/off or cycled yet.
 - If needed, click  to stop the outlet-switching operation.

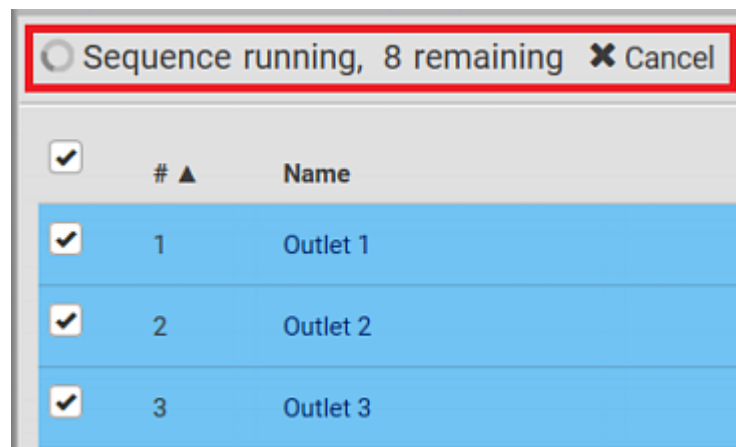

Available Data of the Outlets Overview Page

All of the following outlet data is displayed on the outlets overview page based on your selection. To show or hide specific data, click . See **Outlets** (on page 158).

- Receptacle type
- Lines associated with each outlet





Setting Outlet Power-On Sequence and Delay

By default, outlets are sequentially powered on in the ascending order from outlet 1 to the final when turning ON or power cycling all outlets on the PX3 device. You can change the order in which the outlets power ON. This is useful when there is a specific order in which some IT equipment should be powered up first.

In addition, you can make a delay occur between two outlets that are turned on consecutively. For example, if the power-on sequence is Outlet 1 through Outlet 8, and you want the PX3 to wait for 5 seconds after turning on Outlet 3 before turning on Outlet 4, assign a delay of 5 seconds to Outlet 3.

► **To set the outlet power-on sequence:**

1. On the Outlets page, click  > Sequence Setup.
2. Select one or multiple outlets by clicking them one by one in the 'Outlet' column.
3. Click the arrow buttons to change the outlet positions.

Button	Function
	Top
	Up
	Down
	Bottom
	Restores to the default sequence

Next time when power cycling the PX3, it will turn on all outlets based on the new outlet order.

The new order also applies when performing the power-on or power-cycling operation on partial outlets.

► **To set a power-on delay for any outlet:**

1. On the same outlets list, click the 'Delay' column of the outlet that requires a wait after it is turned on.
2. Type a new value in seconds.
3. Click Save.

The PX3 will insert a power-on delay between the configured outlet and the one following it during the power-on process.

Setting Non-Critical Outlets

Outlets that are turned off when load shedding is activated are called non-critical. Outlets that are not affected by load shedding are called critical outlets. See *Load Shedding Mode* (on page 164).

Per default, all outlets are configured as critical.

► **To determine critical and non-critical outlets:**

1. On the Outlets page, click  > Load Shedding Setup.
2. To set non-critical outlets, select the checkboxes of those you want.
 - To select ALL outlets, select the topmost checkbox in the header row.
3. To turn non-critical outlets into critical ones, deselect their checkboxes.
 - To deselect ALL outlets, deselect the topmost checkbox in the header row.
4. Click Save.

*Tip: You can also set up non-critical outlet setting by configuring outlets one by one. See **Individual Outlet Pages** (on page 165).*

Load Shedding Mode

When a UPS supplying power to the PX3 switches into battery backup operation, it may be desirable to switch off non-critical outlets to conserve UPS battery life. This feature is known as load shedding.

Outlets that are turned off when load shedding is activated are called non-critical. Outlets that are not affected by load shedding are called critical outlets. By default, all outlets are critical. To set non-critical ones, see **Setting Non-Critical Outlets** (on page 163).

When load shedding is activated, the PX3 turns off all non-critical outlets. When load shedding is deactivated, the PX3 turns back on all non-critical outlets that were ON before entering the load shedding mode.

Activation of load shedding can be accomplished using the web interface, SNMP or CLI, or triggered by the contact closure sensors.





*Note: It is highly suggested to check the non-critical outlets prior to manually entering the load shedding mode. The non-critical information can be retrieved from the Outlets page. See **Outlets** (on page 158) or **Available Data of the Outlets Overview Page** (on page 162).*

► **To enter the load shedding mode:**

1. On the Outlets page, click  > Activate Load Shedding.
2. Click Activate on the confirmation message.

In the load shedding mode:

- The lock icon  appears for all non-critical outlets on the Outlets page, and you CANNOT turn on any of them.
- The message "Load Shedding Active" appears next to the 'Outlets' title.

#	Name	Status	RMS Current	Active Power	Power Factor	Non Critical
1	Outlet 1	 off	0.000 A	0 W	1.00	true
2	Outlet 2	 off	0.000 A	0 W	1.00	true
3	Outlet 3	 off	0.000 A	0 W	1.00	true
4	Outlet 4	 on	0.000 A	0 W	1.00	false
5	Outlet 5	 on	0.000 A	0 W	1.00	false

*Tip: To make the Non Critical column appear on the Outlets page. See **Outlets** (on page 158) or **Available Data of the Outlets Overview Page** (on page 162).*

► **To exit from the load shedding mode:**

1. On the Outlets page, click  > Deactivate Load Shedding.
2. Click Deactivate on the confirmation message.

Now you can turn on/off any outlets.

Individual Outlet Pages

An outlet's data/setup page is opened after clicking the outlet's name on the Outlets overview page. See **Outlets** (on page 158).

Outlets	
# ▲	Name
1	Outlet 1
2	Outlet 2
3	Outlet 3
4	Outlet 4

The individual outlet's page shows this outlet's detailed information. See *Detailed Information on Outlet Pages* (on page 168).

In addition, you can perform the following operations on this outlet page. Note that only outlet-switching capable models show the power-control buttons, and you must have the Switch Outlet permission for performing outlet-switching operations. Therefore, PX3-1000 series does not support the following power control operation.

► **To power control this outlet:**

1. Click one of the power-control buttons.

The screenshot shows the 'Outlet 1' page. At the top right, there are three buttons: 'On' (with a power icon), 'Off' (with a power icon), and 'Cycle' (with a refresh icon). These buttons are highlighted with a red box. Below the buttons is a 'Details' table with the following information:

Details	
Label	1
Outlet Status	on
Receptacle Type	IEC 60320 C19
Lines	L1-NEUTRAL
Inlet	Inlet I1
Overcurrent Protector	Overcurrent Protector C1

Button/command	Action
On	Power ON.
Off	Power OFF.
Cycle	Power cycle. <ul style="list-style-type: none"> ▪ Power cycling the outlet(s) turns the outlet(s) off and then back on.

2. Confirm it on the confirmation message.

► **To configure this outlet:**

1. Click Edit Settings.

Settings	
	Edit Settings
Name	
State on device startup	PDU defined (last known)
Power off period during power cycle	PDU defined (10 seconds)
Non-critical	False

2. Configure available fields. Note that the fields marked with * are only available on outlet-switching capable models.

Field	Descriptions
Name	Type an outlet name up to 32 characters long.
*State on device startup	<p>Click this field to select this outlet's initial power state after the PX3 powers up.</p> <ul style="list-style-type: none"> Options: <i>on</i>, <i>off</i>, <i>last known</i> and <i>PDU defined</i>. See <i>Options for Outlet State on Startup</i> (on page 150). Note that any option other than "PDU defined" will override the global outlet state setting on this particular outlet.
*Power off period during power cycle	<p>Select an option to determine how long this outlet is turned off before turning back on.</p> <ul style="list-style-type: none"> Options: <i>PDU defined</i> or customized time. See <i>Power-Off Period Options for Individual Outlets</i> (on page 169). Note that any time setting other than "PDU defined" will override the global power-off period setting on this particular outlet.
*Non-critical	Select this checkbox only when you want this outlet to turn off in the load shedding mode. See <i>Load Shedding Mode</i> (on page 164).

3. Click Save.
4. The outlet's custom name, if available, is displayed in the outlets list, following by its label in parentheses.

► **Other operations:**

- You can go to another outlet's data/setup page by clicking the outlet selector  on the top-left corner.
- You can go to the associated Inlet's or overcurrent protector's data pages by clicking the Inlet or Overcurrent Protector links in the Details section.



Outlet 1

 On
  Off
  Cycle

Details	
Label	1
Outlet Status	 on
Receptacle Type	IEC 60320 C19
Lines	L1-NEUTRAL
Inlet	Inlet I1
Overcurrent Protector	Overcurrent Protector C1

Detailed Information on Outlet Pages

Each outlet's data page has the Details section for showing general outlet information.

► **Details section:**

Field	Description
Label	The physical outlet number
Outlet Status	<div style="background-color: #f2f2f2; padding: 5px; margin-bottom: 5px;">This information is only available on outlet-switching capable models.</div> On or Off
Receptacle Type	This outlet's receptacle type
Lines	Lines associated with this outlet

Field	Description
Inlet	<p>This information is useful when there are multiple inlets on your PDU.</p> <p>Inlet associated with this outlet</p>
Overcurrent Protector	<p>This information is available only when your PX3 has overcurrent protectors.</p> <p>Overcurrent protector associated with this outlet</p>

Power-Off Period Options for Individual Outlets

There are two options for setting the power-off period during the power cycle on each individual outlet's page. See *Individual Outlet Pages* (on page 165).

Option	Function
PDU defined (xxx)	Follows the global power-off period setting, which is set on <i>PDU</i> (on page 145). The value xxx in parentheses is the current global value.
Customized time	<p>If selecting this option, do either of the following:</p> <ul style="list-style-type: none"> Click  to select an existing time option. Type a new value <i>with an appropriate time unit added</i>. See <i>Time Units</i> (on page 153).

OCPs

This page is available only when your PX3 has overcurrent protectors, such as circuit breakers.

The OCPs page lists all overcurrent protectors as well as their status. If any OCP trips or its current level enters the alarmed state, it is highlighted in red or yellow. See *Yellow- or Red-Highlighted Sensors* (on page 180).

To open the OCPs page, click 'OCPs' in the *Menu* (on page 132).

You can go to each OCP's data/setup page by clicking its name on this page.

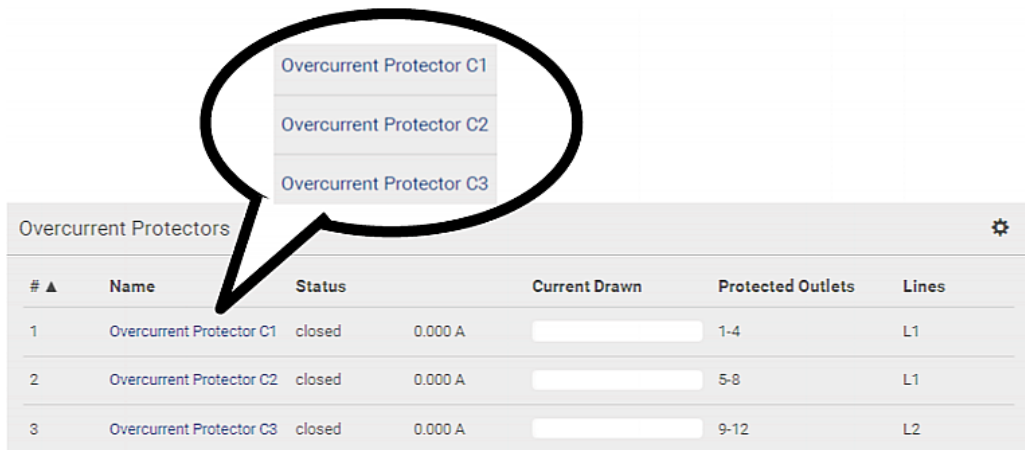

The screenshot shows a table titled "Overcurrent Protectors" with a settings gear icon in the top right. A callout bubble points to the names of the three protectors in the table. The table has columns for #, Name, Status, Current Drawn, Protected Outlets, and Lines.



# ▲	Name	Status	Current Drawn	Protected Outlets	Lines
1	Overcurrent Protector C1	closed	0.000 A	1-4	L1
2	Overcurrent Protector C2	closed	0.000 A	5-8	L1
3	Overcurrent Protector C3	closed	0.000 A	9-12	L2

If wanted, you can resort the list by clicking the desired column header. See *Sorting a List* (on page 134).

► **Overcurrent protector overview:**

- OCP status - open (tripped) or closed
- Current drawn and current bar

The RMS current bars change colors to indicate the status if the OCP thresholds have been configured and enabled.

Status	Bar colors
normal	
above upper warning	
above upper critical	

Note: The "below lower warning" and "below lower critical" states also show yellow and red colors respectively. However, it is not meaningful to enable these two thresholds for current levels.

- Protected outlets, which are indicated with outlet numbers
- Associated lines

► **To configure current thresholds for multiple overcurrent protectors:**

OCP thresholds, when enabled, help you identify the OCP whose RMS current enters the warning or critical level with the yellow or red color. In addition, you can have the PX3 automatically generate alert notifications for any warning or critical status. See *Event Rules and Actions* (on page 272).

1. Click  > Threshold Bulk Setup.
2. Select one or multiple OCPs.
 - To select all OCPs, simply click the topmost checkbox in the header row.
3. Click Edit Thresholds.
4. Make changes as needed.
 - To enable any threshold, select the corresponding checkbox.
 - Type a new value in the accompanying text box.

For concepts of thresholds, deassertion hysteresis and assertion timeout, see *Sensor Threshold Settings* (on page 675).

5. Click Save.

Individual OCP Pages

An OCP's data/setup page is opened after clicking any OCP's name on the OCPs or Dashboard page. See *OCPs* (on page 170) or *Dashboard* (on page 135).

► **General OCP information:**

Field	Description
Label	This OCP's physical number
Status	open or closed
Type	This OCP's type
Rating	This OCP's rated current
Lines	Lines associated with this OCP
Protected Outlets	Outlets associated with this OCP
Inlet	Inlet associated with this OCP This information is useful only when your PDU has multiple inlets.
RMS current	This OCP's current state and readings, including current drawn and current remaining

► **To customize this OCP's name:**

1. Click Edit Settings.
2. Type a name.
3. Click Save.

► **To view this OCP's power waveform:**

This OCP's RMS current data in waveform is shown in the Overcurrent Protector History section.

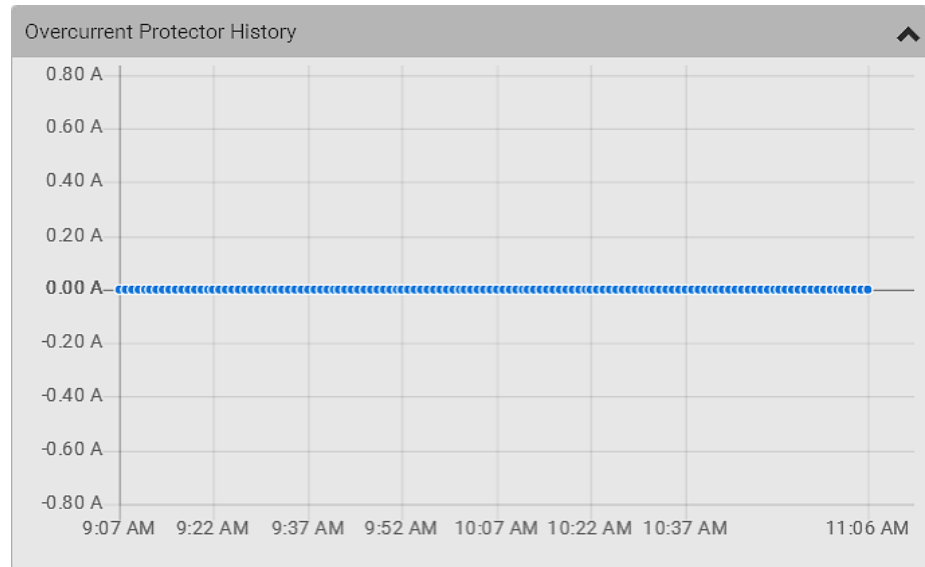

► **To configure this OCP's threshold settings:**

1. Click the Thresholds title bar at the bottom of the page to display the threshold data.



2. Click the **RMS current sensor** (required), and then click Edit Thresholds.
3. Make changes as needed.
 - To enable any threshold, select the corresponding checkbox.
 - Type a new value in the accompanying text box.

For concepts of thresholds, deassertion hysteresis and assertion timeout, see *Sensor Threshold Settings* (on page 675).
4. Click Save.

*Tip: To configure thresholds for multiple OCPs at a time, see **OCPs** (on page 170).*

► **Other operations:**

- You can go to another OCP's data/setup page by clicking the OCP selector  on the top-left corner.
- You can go to the associated Inlet's data page by clicking the Inlet link in the Details section.



Overcurrent Protector C1

Details	
Label	C1
Status	closed
Type	1-Pole Circuit Breaker
Rating	16 A
Lines	L1
Protected Outlets	1-4
Inlet	Inlet I1

Peripherals

If there are Raritan environmental sensor packages connected to the PX3, they are listed on the Peripherals page. See **Connecting Environmental Sensor Packages** (on page 53).

An environmental sensor package comprises one or some of the following sensors/actuators:

- Numeric sensors: Detectors that show both readings and states, such as temperature sensors.
- State sensors: Detectors that show states only, such as contact closure sensors.
- Actuators: An actuator controls a system or mechanism so it shows states only.

The PX3 communicates with *managed* sensors/actuators only and retrieves their data. It does not communicate with unmanaged ones. See **Managed vs Unmanaged Sensors/Actuators** (on page 181).

When the number of "managed" sensors/actuators has not reached the maximum, the PX3 automatically brings newly-detected sensors/actuators under management by default.

One PX3 can manage a maximum of 32 sensors/actuators.

Note: To disable the automatic management function, go to PDU (on page 145). You need to manually manage a sensor/actuator only when it is not under management.

When any sensor/actuator is no longer needed, you can unmanage/release it.

Open the Peripherals page by clicking Peripherals in the **Menu** (on page 132). Then you can:

- Perform actions on multiple sensors/actuators by using the control/action icons on the top-right corner.

Peripheral Devices							On	Off		
# ▲	Name	Reading	State	Type	Serial Number	Position	Actuator			
1	On/Off 1		normal	Contact Closure	QLLemu0001	Port 1, Chain Position 1, Channel 1				
2	On/Off 2		normal	Contact Closure	QLLemu0001	Port 1, Chain Position 1, Channel 3				
3	Temperature 1	24.0 °C	normal	Temperature	QMTemu0005	Port 1, Chain Position 5				
4	Absolute Humidity 1	9.2 g/m ³	normal	Absolute Humidity	QMSemu0004	Port 1, Chain Position 4				
5	Relative Humidity 1	42 %	normal	Humidity	QMSemu0004	Port 1, Chain Position 4				
6	On/Off 5		normal	Contact Closure	QLLemu0001	Port 1, Chain Position 1, Channel 5				

- Go to an individual sensor's or actuator's data/setup page by clicking its name.

Peripheral Devices	
# ▲	Name
1	On/Off 1
2	On/Off 2
3	Temperature 1
4	Absolute Humidity 1
5	Relative Humidity 1

If wanted, you can resort the list by clicking the desired column header. See *Sorting a List* (on page 134).

► **Sensor/actuator overview on this page:**

If any sensor enters the alarmed state, it is highlighted in yellow or red. See *Yellow- or Red-Highlighted Sensors* (on page 180). An actuator is never highlighted.

Column	Description
Name	By default the PX3 assigns a name comprising the following two elements to a newly-managed sensor/actuator. <ul style="list-style-type: none"> ▪ Sensor/actuator type, such as "Temperature" or "Dry Contact." ▪ Sequential number of the same sensor/actuator type, like 1, 2, 3 and so on. You can customize the name. See <i>Individual Sensor/Actuator Pages</i> (on page 188).
Reading	Only managed 'numeric' sensors show this data, such as temperature and humidity sensors.
State	The data is available for all sensors and actuators. See <i>Sensor/Actuator States</i> (on page 182).
Type	Sensor or actuator type.

Column	Description
Serial Number	This is the serial number printed on the sensor package's label. It helps to identify your Raritan sensors/actuators. See <i>Finding the Sensor's Serial Number</i> (on page 184).
Position	The data indicates where this sensor or actuator is located in the sensor chain. See <i>Identifying the Sensor Position and Channel</i> (on page 185).
Actuator	Indicates whether this sensor package is an actuator or not. If yes, the symbol  is shown.

► **To release or manage sensors/actuators:**

When the total of managed sensors/actuators reaches the maximum (32), you cannot manage additional ones. The only way to manage any sensor/actuator is to release or replace any managed ones. To replace a managed sensor/actuator, see ***Managing One Sensor or Actuator*** (on page 186). To release any one, follow this procedure.

1. Click  to make checkboxes appear in front of sensors/actuators.

Tip: To perform the desired action on only one sensor/actuator, simply click that sensor/actuator without making the checkboxes appear.

2. Select multiple sensors/actuators.
 - To release sensors/actuators, you must only select "managed" ones. See ***Sensor/Actuator States*** (on page 182).
 - To manage sensors/actuators, you must only select "unmanaged" ones.
 - To select ALL sensors/actuators, select the topmost checkbox in the header row.
3. To release selected ones, click  > Release.

To manage them, click  > Manage.

- The management action triggers a "Manage peripheral device" dialog. Simply click Manage if you are managing *multiple* sensors/actuators.

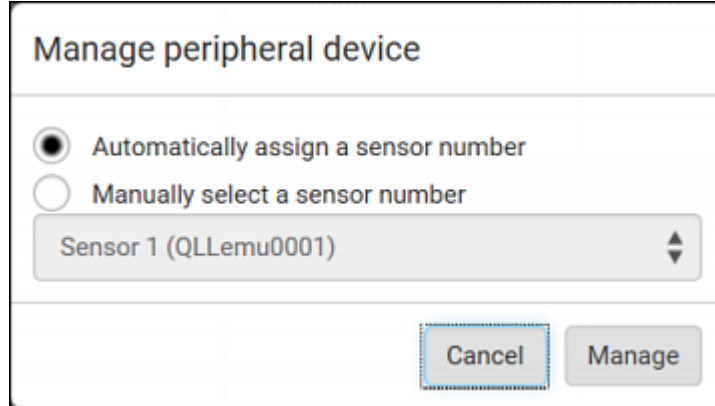

- If you are managing only *one* sensor/actuator, you can choose to assign an ID number by selecting "Manually select a sensor number." See ***Managing One Sensor or Actuator*** (on page 186).
4. Now released sensors/actuators become "unmanaged."
Managed ones show one of the managed states.

► **To configure default threshold settings:**

Note that any changes made to default threshold settings not only re-determine the initial threshold values applying to newly-added sensors but also the threshold values of the already-managed sensors where default thresholds are being used. See ***Individual Sensor/Actuator Pages*** (on page 188).

1. Click  > Default Threshold Setup.

- Click the desired sensor type (required), and then click Edit Thresholds.

Peripherals Default Thresholds				
				Edit Thresholds
Sensor Type	Lower Critical	Lower Warning	Upper Warning	Upper Critical
Absolute Humidity	2 g/m ³	4 g/m ³	20 g/m ³	22 g/m ³
Air Flow	0.4 m/s	0.8 m/s	2.6 m/s	3.2 m/s
Air Pressure	---	---	80 Pa	100 Pa
Relative Humidity	10 %	15 %	85 %	90 %
Temperature	10 °C	15 °C	30 °C	35 °C
Vibration	---	---	0.05 g	0.1 g

- Make changes as needed.
 - To enable any threshold, select the corresponding checkbox.
 - Type a new value in the accompanying text box.

For concepts of thresholds, deassertion hysteresis and assertion timeout, see **Sensor Threshold Settings** (on page 675).

- Click Save.

*Tip: To customize the threshold settings on a per-sensor basis, go to **Individual Sensor/Actuator Pages** (on page 188).*

► **To turn on or off any actuator(s):**

- Select one or multiple actuators which are *in the same status* - on or off.

- To select multiple actuators, click  to make checkboxes appear and then select desired actuators.

- Click the desired button.

 **On** : Turn ON.

 **Off** : Turn OFF.

- Confirm the operation when prompted.

*Tip: If intending to control the actuator via the front panel, see **Front Panel Settings** (on page 324).*

Yellow- or Red-Highlighted Sensors





The PX3 highlights those sensors that enter the abnormal state with a yellow or red color. Note that numeric sensors can change colors only after you have enabled their thresholds.



Tip: When an actuator is turned ON, it is also highlighted in red for drawing attention.

For concepts of thresholds, deassertion hysteresis and assertion timeout, see **Sensor Threshold Settings** (on page 675).

# ▲	Name	Reading	State	Type	Serial Number	Position	Actuator
1	Temperature 1	25.0 °C	above upper critical	Temperature	AEH2A51454	Port 1	
2	Absolute Humidity 1	10.8 g/m³	normal	Absolute Humidity	AEI1750551	Port 4	
3	Absolute Humidity 2	11.0 g/m³	above upper warning	Absolute Humidity	AEI2850240	Port 4	
4	Temperature 2	25.8 °C	above upper critical	Temperature	AEI2A50775	Port 1	
5	Relative Humidity 1	44 %	normal	Humidity	AEI2A50775	Port 1	

In the following table, "R" represents any numeric sensor's reading. The symbol <= means "smaller than" or "equal to."

Sensor status	Color	States shown in the interface	Description
Unknown		unavailable	Sensor state or readings cannot be detected.
		unmanaged	Sensors are not being managed. See Managed vs Unmanaged Sensors/Actuators (on page 181).
Normal		normal	<ul style="list-style-type: none"> Numeric or state sensors are within the normal range. -- OR -- No thresholds have been enabled for numeric sensors.
		above upper warning	Upper Warning threshold < "R" <= Upper Critical threshold
Warning		below lower warning	Lower Critical threshold <= "R" < Lower Warning threshold
		above upper critical	Upper Critical threshold < "R"
Critical		below lower critical	"R" < Lower Critical threshold

Sensor status	Color	States shown in the interface	Description
Alarmed		alarmed	State sensors enter the abnormal state.
OCP alarm		Open	<ul style="list-style-type: none"> ▪ Circuit breaker trips. -- OR -- ▪ Fuse blown.

If you have connected a Schroff® LHX/SHX heat exchanger, when any sensor implemented on that device fails, it is also highlighted in red.

Managed vs Unmanaged Sensors/Actuators

To manually manage or unmanage/release a sensor or actuator, see *Peripherals* (on page 175).

► Managed sensors/actuators:

- The PX3 communicates with managed sensors/actuators and retrieves their data.
- Managed sensors/actuators are always listed on the Peripheral Devices page no matter they are physically connected or not.
- They have an ID number as illustrated below.

Peripheral Devices	
# ▲	Name
1	On/Off 1
2	On/Off 2
3	Temperature 1
4	Absolute Humidity 1
5	Relative Humidity 1

- They show one of the managed states. See *Sensor/Actuator States* (on page 182).
 - For managed 'numeric' sensors, their readings are retrieved and displayed. If any numeric sensor is disconnected or its reading cannot be retrieved, it shows "unavailable" for its reading.
- ▶ **Unmanaged sensors/actuators:**
- The PX3 neither communicates with unmanaged sensors/actuators nor retrieves their data.
 - Unmanaged sensors/actuators are listed only when they are physically connected to the PX3. They disappear when they are no longer connected.
 - They do *not* have an ID number.
 - They show the "unmanaged" state.

Sensor/Actuator States

An environmental sensor or actuator shows its real-time state after being managed.

Available sensor states depend on the sensor type -- numeric or state sensors. For example, a contact closure sensor is a state sensor so it switches between three states only -- *unavailable*, *alarmed* and *normal*.

Sensors will be highlighted in yellow or red when they enter abnormal states. See *Yellow- or Red-Highlighted Sensors* (on page 180).

An actuator's state is marked in red when it is turned on.

▶ **Managed sensor states:**

In the following table, "R" represents any numeric sensor's reading. The symbol \leq means "smaller than" or "equal to."

State	Description
normal	<ul style="list-style-type: none"> ▪ For numeric sensors, it means the readings are within the normal range. ▪ For state sensors, it means they enter the normal state.
below lower critical	"R" < Lower Critical threshold
below lower warning	Lower Critical threshold \leq "R" < Lower Warning threshold
above upper warning	Upper Warning threshold < "R" \leq Upper Critical threshold
above upper critical	Upper Critical threshold < "R"

State	Description
alarmed	The state sensor enters the abnormal state.
unavailable	<ul style="list-style-type: none"> ▪ The communication with the managed sensor is lost. -- OR -- ▪ DPX2, DPX3 or DX sensor packages are upgrading their sensor firmware.

Note that for a contact closure sensor, the normal state depends on the normal setting you have configured. Refer to the Environmental Sensors Guide or Online Help for detailed information, which is available on Raritan's *Support page* (<http://www.raritan.com/support/>).

► **Managed actuator states:**

State	Description
on	The actuator is turned on.
off	The actuator is turned off.
unavailable	<ul style="list-style-type: none"> ▪ The communication with the managed actuator is lost. -- OR -- ▪ DX sensor packages are upgrading their sensor firmware.

► **Unmanaged sensor/actuator states:**

State	Description
unmanaged	Sensors or actuators are physically connected to the PX3 but not managed yet.

*Note: Unmanaged sensors or actuators will disappear from the web interface after they are no longer physically connected to the PX3. To manage a sensor/actuator, go to **Peripherals** (on page 175).*

Finding the Sensor's Serial Number

A DPX environmental sensor package includes a serial number tag on the sensor cable.



A DPX2, DPX3 or DX sensor package has a serial number tag attached to its rear side.



The serial number for each sensor or actuator appears listed in the web interface after each sensor or actuator is detected by the PX3. Match the serial number from the tag to those listed in the sensor table.

Peripheral Devices On Off							
# ▲	Name	Reading	State	Type	Serial Number	Position	Actuator
1	On/Off 1		normal	Contact Closure	QLLemu0001	Port 1, Chain Position 1, Channel 1	
2	On/Off 2		normal	Contact Closure	QLLemu0001	Port 1, Chain Position 1, Channel 3	
3	Temperature 1	24.0 °C	normal	Temperature	QMTemu0005	Port 1, Chain Position 5	
4	Absolute Humidity 1	9.2 g/m³	normal	Absolute Humidity	QMSemu0004	Port 1, Chain Position 4	
5	Relative Humidity 1	42 %	normal	Humidity	QMSemu0004	Port 1, Chain Position 4	

Identifying the Sensor Position and Channel

Raritan has developed four types of environmental sensor packages - DPX, DPX2, DPX3 and DX series. Only DPX2, DPX3 and DX sensor packages can be daisy chained.

The PX3 can indicate where each sensor or actuator is connected on the Peripheral Devices page.

# ▲	Name	Reading	State	Type	Serial Number	Position	Actuator
1	On/Off 1		normal	Contact Closure	QLLemu0001	Port 1, Chain Position 1, Channel 1	
2	On/Off 2		normal	Contact Closure	QLLemu0001	Port 1, Chain Position 1, Channel 3	
3	Temperature 1	24.0 °C	normal	Temperature	QMTemu0005	Port 1, Chain Position 5	
4	Absolute Humidity 1	9.2 g/m ³	normal	Absolute Humidity	QMSemu0004	Port 1, Chain Position 4	
5	Relative Humidity 1	42 %	normal	Humidity	QMSemu0004	Port 1, Chain Position 4	

- DPX series only shows the sensor port number only.
For example, *Port 1*.
- DPX2, DPX3 and DX series show both the sensor port number and its position in a sensor chain.
For example, *Port 1, Chain Position 2*.
- If a Raritan DPX3-ENVHUB4 sensor hub is involved, the hub port information is also indicated for DPX2, DPX3 and DX series, but NOT indicated for DPX series.
For example, *Hub Port 3*.
- If a sensor/actuator contains channels, such as a contact closure or dry contact sensor, the channel information is included in the position information.
For example, *Channel 1*.

▶ **Sensor/actuator position examples:**

Example	Physical position
Port 1	Connected to the sensor port #1.
Port 1, Channel 2	<ul style="list-style-type: none"> ▪ Connected to the sensor port #1. ▪ The sensor/actuator is the 2nd channel of the sensor package.
Port 1, Chain Position 4	<ul style="list-style-type: none"> ▪ Connected to the sensor port #1. ▪ The sensor/actuator is located in the 4th sensor package of the sensor chain.
Port 1, Chain Position 3, Channel 2	<ul style="list-style-type: none"> ▪ Connected to the sensor port #1. ▪ The sensor/actuator is located in the 3rd sensor package of the sensor chain. ▪ It is the 2nd channel of the sensor package.
Port 1, Chain Position 1, Hub Port 2, Chain Position 3	<ul style="list-style-type: none"> ▪ Connected to the sensor port #1. ▪ Connected to the 2nd port of the DPX3-ENVHUB4 sensor hub, which shows the following two pieces of information: <ul style="list-style-type: none"> ▪ The hub's position in the sensor chain -- "Chain Position 1" ▪ The hub port where this particular sensor package is connected -- "Hub Port 2" ▪ The sensor/actuator is located in the 3rd sensor package of the sensor chain connected to the hub's port 2.

Managing One Sensor or Actuator

If you are managing only one sensor or actuator, you can assign the desired ID number to it. Note that you cannot assign ID numbers when you are managing multiple sensors/actuators at a time.

*Tip: When the total of managed sensors/actuators reaches the maximum (32), you cannot manage additional ones. The only way to manage any sensor/actuator is to release or replace any managed ones. To replace a managed one, assign an ID number to it by following this procedure. To release any one, see **Peripherals** (on page 175).*

► **To manage only one sensor/actuator:**

1. From the list of "unmanaged" sensors/actuators, click the one you want to manage.

- The "Manage peripheral device" dialog appears.

The screenshot shows a dialog box titled "Manage peripheral device". It contains two radio button options: "Automatically assign a sensor number" (which is selected) and "Manually select a sensor number". Below these options is a dropdown menu currently displaying "Sensor 1 (QLLemu0001)". At the bottom right of the dialog are two buttons: "Cancel" and "Manage".

- To let the PX3 randomly assign an ID number to it, select "Automatically assign a sensor number." This method does not release any managed sensor or actuator.
- To assign the desired ID number to it, select "Manually select a sensor number." Then click  to select an ID number. This method may release a managed sensor/actuator if the number you selected has been assigned to a specific sensor/actuator.

Tip: The information in parentheses following each ID number indicates whether the number has been assigned to a sensor or actuator. If it has been assigned to a sensor or actuator, it shows its serial number. Otherwise, it shows the word "unused."

- Click Manage.

► **Special note for a Raritan humidity sensor:**

A Raritan humidity sensor is able to provide two measurements - relative and absolute humidity values.

- A relative humidity value is measured in percentage (%).
- An absolute humidity value is measured in grams per cubic meter (g/m³).

However, only relative humidity sensors are "automatically" managed if the automatic management function is enabled. You must "manually" manage absolute humidity sensors as needed.

Note that relative and absolute values of the same humidity sensor do NOT share the same ID number though they share the same serial number and position.

Peripheral Devices On						
# ▲	Name	Reading	State	Type	Serial Number	Position
1	On/Off 1		normal	Contact Closure	QLLemu0001	Port 1, Chain Position 1, Channel 1
2	On/Off 2		normal	Contact Closure	QLLemu0001	Port 1, Chain Position 1, Channel 3
3	Relative Humidity 1	42 %	normal	Humidity	QMSemu0004	Port 1, Chain Position 4
4	Absolute Humidity 1	9.2 g/m ³	normal	Absolute Humidity	QMSemu0004	Port 1, Chain Position 4
5	Temperature 1	24.0 °C	normal	Temperature	QMSemu0004	Port 1, Chain Position 4

Individual Sensor/Actuator Pages

A sensor's or actuator's data/setup page is opened after clicking any sensor or actuator name on the Peripheral Devices page. See *Peripherals* (on page 175).

Note that only a numeric sensor has threshold settings, while a state sensor or actuator has no thresholds.

Threshold settings, if enabled, help you identify whether any numeric sensor enters the warning or critical level. See *Yellow- or Red-Highlighted Sensors* (on page 180). In addition, you can have the PX3 automatically generate alert notifications for any warning or critical status. See *Event Rules and Actions* (on page 272).

► **To configure a numeric sensor's threshold settings:**

1. Click Edit Thresholds.

Sensor	
	Edit Thresholds
Reading	24.7 °C
State	normal
Last Time Changed	2/18/2017, 5:48:21 PM

2. Select or deselect Use Default Thresholds according to your needs.

The screenshot shows a 'Sensor' configuration window with a title bar 'Sensor' and a button 'Edit Thresholds' in the top right. The main content area contains several settings:

- Use Default Thresholds:** A checkbox that is checked and highlighted with a red rectangle.
- Lower Critical:** A checked checkbox, a text input field containing '10', and a unit dropdown menu set to '°C'.
- Lower Warning:** A checked checkbox, a text input field containing '15', and a unit dropdown menu set to '°C'.
- Upper Warning:** A checked checkbox, a text input field containing '57', and a unit dropdown menu set to '°C'.
- Upper Critical:** A checked checkbox, a text input field containing '68', and a unit dropdown menu set to '°C'.
- Deassertion Hysteresis:** A text input field containing '1' and a unit dropdown menu set to '°C'.
- Assertion Timeout:** A text input field containing '0' and a unit dropdown menu set to 'Samples'.

At the bottom right of the window are two buttons: 'Cancel' (with an 'X' icon) and 'Save' (with a checkmark icon).

- To have this sensor follow the default threshold settings configured for its sensor type, select the Use Default Thresholds checkbox.
The default threshold settings are configured on the page of ***Peripherals*** (on page 175).
- To customize the threshold settings for this particular sensor, deselect the Use Default Thresholds checkbox, and then modify the threshold fields below it.

*Note: For concepts of thresholds, deassertion hysteresis and assertion timeout, see **Sensor Threshold Settings** (on page 675).*

3. Click Save.

► To set up a sensor's or actuator's physical location and additional settings:

1. Click Edit Settings.

Settings	
	Edit Settings
Name	Temperature 1
Description	
Location (X)	
Location (Y)	
Location (Z: Rack Units)	

2. Make changes to available fields, and then click Save.

Fields	Description
Binary Sensor Subtype	<p>This field is available for a contact closure sensor only.</p> <p>Determine the sensor type of your contact closure detector.</p> <ul style="list-style-type: none"> ▪ <i>Contact Closure</i> detects the door lock or door open/closed status. ▪ <i>Smoke Detection</i> detects the appearance of smoke. ▪ <i>Water Detection</i> detects the appearance of water on the floor. ▪ <i>Vibration</i> detects the vibration of the floor.
Name	A name for the sensor or actuator.
Description	Any descriptive text you want.
Location (X, Y and Z)	<p>Describe the sensor's or actuator's location in the data center by typing alphanumeric values for the X, Y and Z coordinates. See <i>Sensor/Actuator Location Example</i> (on page 192).</p> <p>If the term "Rack Units" appears in parentheses in the Z location, you must type an integer number. Note that the Z coordinate's format is determined on the page of <i>PDU</i> (on page 145).</p>
Alarmed to Normal Delay	<p>This field is available for the DX-PIR presence detector only.</p> <p>It determines the wait time before the PX3 announces that the presence detector is back to normal after it actually returns to normal.</p> <p>Adjust the value in seconds.</p>

► **To view a numeric sensor's readings waveform:**

This sensor's data within the past tens of minutes is shown in the waveform diagram. Note that only a numeric sensor has this diagram. State sensors and actuators do not show such data.

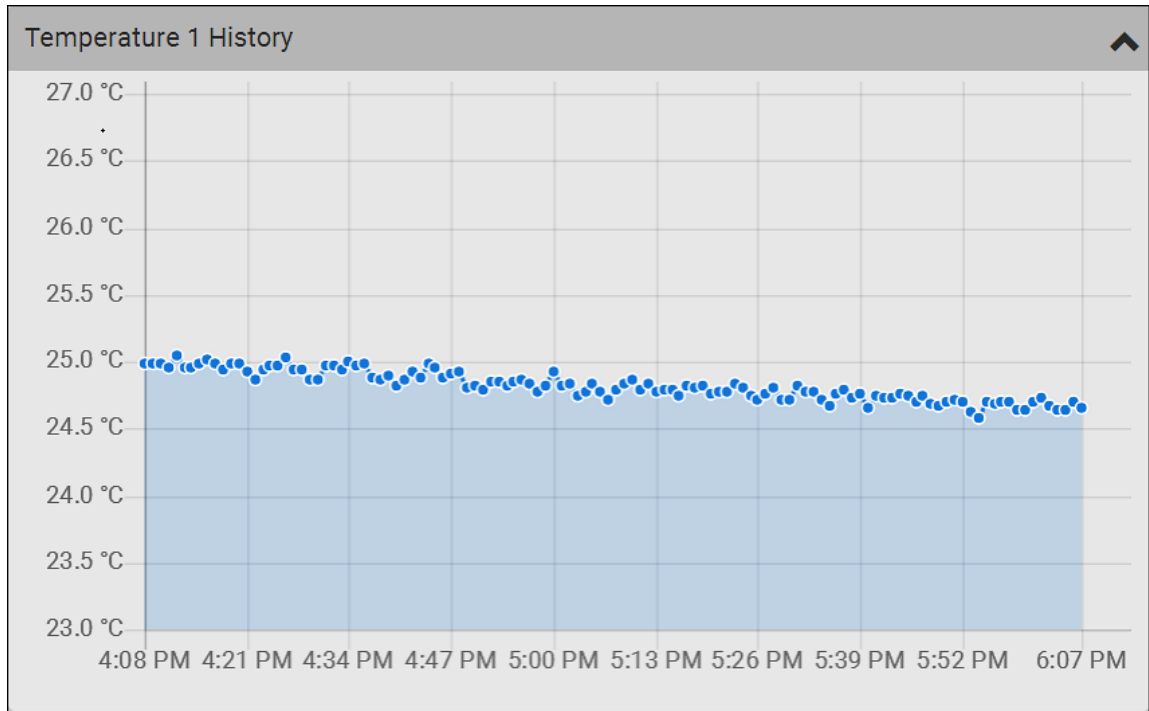

► **To turn on or off an actuator:**

1. Click the desired control button.

⌵ Dry Contact 1 🔴 On 🟢 Off

Details

Peripheral Device ID	7
Position	Port 1, Chain Position 1
Serial Number	QLLemu0001
Type	Contact Closure (On/Off)

🔴 On : Turn ON.

🟢 Off : Turn OFF.

2. Confirm the operation on the confirmation message. An actuator's state is marked in red when it is turned on.

► **Other operations:**

You can go to another sensor's or actuators's data/setup page by clicking

the selector  on the top-left corner.



Temperature 1

Details	
Peripheral Device ID	1
Position	Port 1
Serial Number	AEH2A51454
Type	Temperature

Sensor/Actuator Location Example

Use the X, Y and Z coordinates to describe each sensor's or actuator's physical location in the data center. See *Individual Sensor/Actuator Pages* (on page 188).

The X, Y and Z values act as additional attributes and are not tied to any specific measurement scheme. Therefore, you can use non-measurement values.

► **Example:**

X = Brown Cabinet Row

Y = Third Rack

Z = Top of Cabinet

► **Values of the X, Y and Z coordinates:**

- X and Y: They can be any alphanumeric values comprising 0 to 24 characters.
- Z: When the Z coordinate format is set to *Rack Units*, it can be any number ranging from 0 to 60. When its format is set to *Free-Form*, it can be any alphanumeric value comprising 0 to 24 characters. See *PDU* (on page 145).

Feature Port

The FEATURE port supports connection to the following devices.

Device	Description
Asset Strip	Raritan asset strips
External Beeper	An external beeper with the RJ-45 socket.
LHX 20	Schroff® LHX-20 heat exchanger.
SHX 30	Schroff® SHX-30 heat exchanger.
LHX 40	Schroff® LHX-40 heat exchanger.
Power CIM	<p>This type represents one of the following Raritan products:</p> <ul style="list-style-type: none"> ▪ Raritan power CIM, D2CIM-PWR. This CIM is used to connect the PX3 to the Raritan digital KVM switch -- Dominion KX II / III. ▪ Dominion KSX II ▪ Dominion SX or SX II

When the PX3 detects the connection of any listed device, it replaces 'Feature Port' in the menu with that device's name and shows that device's data/settings instead. See **Asset Strip** (on page 195), **External Beeper** (on page 203), **Schroff LHX/SHX** (on page 204) and **Power CIM** (on page 207).

When no devices are detected, the PX3 displays the name 'Feature Port' and the Feature Port page shows the message "No device is currently connected."

Open the Feature Port page by clicking it in the **Menu** (on page 132). From this page, you can enable or disable this port's detection capability, or force it to show a specific device's data/settings even though no device is detected.

*Note: You must enable the LHX/SHX support for the PX3 to detect the presence of a supported Schroff® LHX/SHX heat exchanger. See **Miscellaneous** (on page 332).*

► **To configure the feature port:**

1. Click  on the top-right corner. The Feature Port Setup dialog appears.

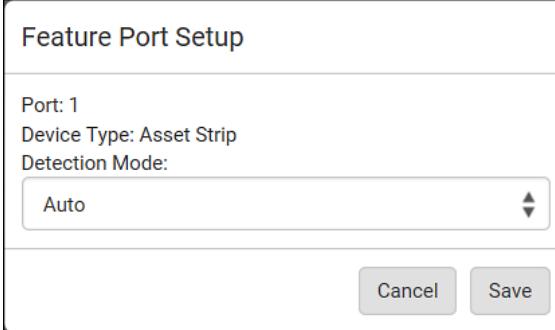

The image shows a dialog box titled "Feature Port Setup". It contains the following text: "Port: 1", "Device Type: Asset Strip", and "Detection Mode:". Below the text is a dropdown menu with "Auto" selected. At the bottom right of the dialog are two buttons: "Cancel" and "Save".

2. Click the Detection Mode field, and select one mode.

Mode	Description
Auto	Enable the port to automatically detect the device connection.
Disabled	Disable the port's detection capability.

Mode	Description
Asset Strip, Raritan asset strips, LHX 20, SHX 30, LHX 40, Power CIM	Force the PX3 to show the selected device's data/setup page regardless of the physical connection status.

*Note: 'LHX 20', 'SHX 30', and 'LHX 40' are not available when the support of LHX/SHX heat exchangers is disabled. See **Miscellaneous** (on page 332).*

Asset Strip

After connecting and detecting Raritan asset management strips (asset strips), the PX3 shows 'Asset Strip' in place of 'Feature Port' in the menu.

*Note: For connection instructions, see **Connecting Asset Management Strips** (on page 72).*

To open the Asset Strip page, click it in the **Menu** (on page 132). On this page, you can configure the rack units of asset strips and asset tags. A rack unit refers to a tag port on the asset strips. The "Change Asset Strip Configuration" permission is required.

For the functionality of this icon  on the top-right corner, see **Feature Port** (on page 193).

► To configure asset strip and rack unit settings:

1. Click Edit Settings.

Settings		Edit Settings
Name		
Number of Rack Units	48	
Numbering Mode	Bottom-Up	
Numbering Offset	1	
Orientation	Bottom Connector	

2. Make changes to the settings by directly typing a new value, or clicking that field to select a different option.

Field	Description
Name	Name for this asset strip assembly.
Number of Rack Units	<p>Total of available tag ports on this asset strip assembly, ranging between 8 and 64.</p> <ul style="list-style-type: none"> For the current generation of asset strips, which show the suffix "G3" on its hardware label, the PX3 automatically detects the number of its tag ports (rack units), and you <i>cannot</i> change this value. For old "non-G3" asset strips, there is no automatic detection for them so you must manually adjust this value.
Numbering Mode	<p>The rack unit numbering method in a rack/cabinet.</p> <ul style="list-style-type: none"> <i>Top-Down</i>: The numbering starts from the highest rack unit of a rack/cabinet. <i>Bottom-Up</i>: The numbering starts from the lowest rack unit of a rack/cabinet.
Numbering Offset	<p>The start number in the rack unit numbering. For example, if this value is set to 3, then the first number is 3, the second number is 4, and so on.</p>
Orientation	<p>The asset strip's orientation by indicating the location of its RJ-45 connector.</p> <ul style="list-style-type: none"> <i>Top Connector</i>: The RJ-45 connector is located on the top. <i>Bottom Connector</i>: The RJ-45 connector is located on the bottom. <p>Asset strips can detect their strip orientation and show it in this field.</p> <p>You need to adjust this value only when your asset strips are the oldest ones without tilt sensors implemented.</p>
Color with connected tag	<p>Click this field to determine the LED color denoting the presence of an asset tag.</p> <ul style="list-style-type: none"> Default is green.
Color without connected tag	<p>Click this field to determine the LED color denoting the absence of an asset tag.</p> <ul style="list-style-type: none"> Default is red.

For color settings, there are two ways to set the color.

- Click a color in the color palette.
- Type the hexadecimal RGB value of the color, such as #00FF00.

Enter a color

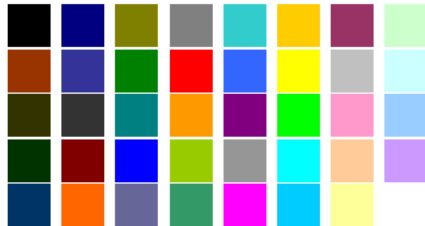







Color code

#00FF00

Cancel Ok

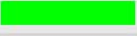
3. Click Ok. The rack unit numbering and LED color settings are immediately updated on the Rack Units list illustrated below.
 - The 'Index' number is the physical tag port number printed on the asset strip, which is not configurable. However, its order will change to reflect the latest rack unit numbering.

Rack Units							Program Asset IDs
Rack unit ▲	Index	Slot	Name	Asset / ID	Operation Mode	LED Mode	LED Color
1	1			000015B914BB	Auto	On	
2	2			000015B9152E	Auto	On	
3	3			000015B9158C	Auto	On	
4	4				Auto	On	
5	5			000015B91600	Auto	On	
6	6			000015B91546	Auto	On	

- A blade extension strip and a *programmable* tag are marked with the word 'programmable' in the Asset/ID column. You can customize their Asset IDs. For instructions, refer to this section's last procedure below.
- If wanted, you can resort the list by clicking the desired column header. See *Sorting a List* (on page 134).

► **To customize a single rack unit's settings:**

You can make a specific rack unit's LED behave differently from the others on the asset strip, including the LED light and color.

1. Click the desired rack unit on the Rack Units list. The setup dialog for the selected one appears.

Setup of Rack Unit 3

Name

Operation Mode

LED Mode

LED Color

2. Make changes to the information by typing a new value or clicking that field to select a different option.

Field	Description
Name	Name for this rack unit. For example, you can name it based on the associated IT device.
Operation Mode	Determine whether this rack unit's LED behavior automatically changes according to the presence and absence of the asset tag. <ul style="list-style-type: none"> ▪ <i>Auto</i>: The LED behavior varies, based on the asset tag's presence. ▪ <i>Manual Override</i>: This option differentiates this rack unit's LED behavior.

Field	Description
LED Mode	<p>This field is configurable only after the Operation Mode is set to Manual Override.</p> <p>Determine how the LED light behaves for this particular rack unit.</p> <ul style="list-style-type: none"> ▪ <i>On</i>: The LED stays lit. ▪ <i>Off</i>: The LED stays off. ▪ <i>Slow blinking</i>: The LED blinks slowly. ▪ <i>Fast blinking</i>: The LED blinks quickly.
LED Color	<p>This field is configurable only after the Operation Mode is set to Manual Override.</p> <p>Determine what LED color is shown for this rack unit if the LED is lit.</p>





► **To expand a blade extension strip:**

A blade extension strip, like an asset strip, has multiple tag ports. An extension strip is marked with a grayer color on the Asset Strip page, and its tag ports list is collapsed by default.

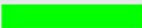

Note: If you need to temporarily disconnect the blade extension strip from the asset strip, wait at least 1 second before re-connecting it back, or the PX3 device may not detect it.

1. Locate the rack unit (tag port) where the blade extension strip is connected. Click its slot number, whose format is similar to

1-N , where N is the total number of its tag ports.

Rack Units							
Program Asset IDs							
Rack unit ▲	Index	Slot	Name	Asset / ID	Operation Mode	LED Mode	LED Color
1	1			000015B914BB	Auto	On	
2	2	1-16 		0000ABC12345 (programmable)	Auto	On	
3	3			000015B9152E	Auto	On	
4	4				Auto	On	

2. All tag ports of the blade extension strip are listed below it. Their port numbers are displayed in the Slot column.

Rack Units							Program Asset IDs
Rack unit ▲	Index	Slot	Name	Asset / ID	Operation Mode	LED Mode	LED Color
1	1			000015B914BB	Auto	On	
2	2	1-16 ▼		0000ABC12345 (programmable)	Auto	On	
	Extension	1		000015B9160A			
	Extension	2		000015B91610			
	Extension	3		000015B91622			
	Extension	4		000015B9158C			
	Extension	5		000015B91600			
	Extension	6		000015B91546			
	Extension	7					
	Extension	8					
	Extension	9					
	Extension	10					
	Extension	11					
	Extension	12					
	Extension	13					
	Extension	14					
	Extension	15					
	Extension	16					
3	3			000015B9152E	Auto	On	









- To hide the blade extension slots list, click **1-N ▼**.

► **To customize asset IDs on programmable asset tags:**

You can customize asset IDs only when the asset tags are "programmable" ones. Non-programmable tags do not support this feature. In addition, you can also customize the ID of a blade extension strip.

If a barcode reader is intended, connect it to the computer you use to access the PX3.

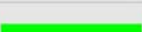
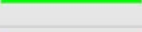
1. Click Program Asset IDs.

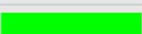
Rack Units							
							Program Asset IDs
Rack unit ▲	Index	Slot	Name	Asset / ID	Operation Mode	LED Mode	LED Color
1	16				Auto	On	
2	15				Auto	On	
3	14				Auto	On	
4	13				Auto	On	
5	12				Auto	On	
6	11				Auto	On	
7	10			(programmable)	Auto	On	
8	9			(programmable)	Auto	On	
9	8			(programmable)	Auto	On	
10	7			00001492BD47	Auto	On	
11	6			00001492CB50	Auto	On	

2. In the Asset/ID column, enter the customized asset IDs by typing values or scanning the barcode.
 - When using a barcode reader, first click the desired rack unit, and then scan the asset tag. Repeat this step for all desired rack units.

- An asset ID contains up to 12 characters that comprise only numbers and/or UPPER CASE alphabets. Lower case alphabets are NOT accepted.

Rack Units				
				Rack Units
Rack unit ▲	Index	Slot	Name	Asset / ID
1	16			Tag ID
2	15			Tag ID
3	14			Tag ID
4	13			Tag ID
5	12			Tag ID
6	11			Tag ID
7	10			WINDOWS
8	9			LINUX
9	8			ROUTER X
10	7			00001492BD47

3. Verify the correctness of customized asset IDs and modify as needed.
4. Click Apply at the bottom of the page or Rack Units (see below) to save changes.

Rack Units				
				Rack Units
Rack unit ▲	Index	Slot	Name	Asset / ID
1	16			Tag ID
2	15			Tag ID

Asset Strip Automatic Firmware Upgrade

After connecting the asset strip to the PX3, it automatically checks its own firmware version against the version of the asset strip firmware stored in the PX3 firmware. If two versions are different, the asset strip automatically starts downloading the new firmware from the PX3 to upgrade its own firmware.

During the firmware upgrade, the following events take place:

- The asset strip is completely lit up, with the blinking LEDs cycling through diverse colors.
- A firmware upgrade process is indicated in the PX3 web interface.
- An SNMP trap is sent to indicate the firmware upgrade event.

External Beeper

After connecting and detecting a supported external beeper, the PX3 shows 'External Beeper' in place of 'Feature Port' in the menu.

*Note: For connection instructions, see **Connecting an External Beeper** (on page 83).*

To open the External Beeper page, click it in the **Menu** (on page 132).

This page shows an external beeper's status, including:

- Number of the FEATURE port where this external beeper is connected
- Its device type
- Its connection status
- The beeper's state - off or active

For the functionality of this icon  on the top-right corner, see **Feature Port** (on page 193).

Schroff LHX/SHX

You must enable the LHX/SHX support for the PX3 to detect the presence of a supported Schroff® LHX/SHX heat exchanger. See *Miscellaneous* (on page 332).

After enabling the LHX/SHX support and connecting a supported Schroff® LHX/SHX heat exchanger to the PX3, the PX3 shows the connected device type in place of 'Feature Port' in the menu -- LHX 20, LHX 40 or SHX 30.

*Note: For connection instructions, see **Connecting a Schroff LHX/SHX Heat Exchanger** (on page 84).*

To open the LHX/SHX page, click 'LHX 20', 'LHX 40' or 'SHX 30' in the *Menu* (on page 132). Then you can monitor and administer the connected LHX/SHX device with the following.

- Name the heat exchanger
- Monitor LHX/SHX built-in sensors and device states
- Configure the air outlet temperature setpoint
- Configure the default fan speed
- Configure the air temperature/fan speed thresholds (for alert generation)
- Request maximum cooling using the fan speed and opening the cold water valve
- Acknowledge alerts or errors remotely, such as failed LHX/SHX sensors or emergency cooling activation
- Accumulative operating hours
- Indicate the number of power supplies present and whether a condenser pump is present

Available information/operation is model dependent. For example, only LHX devices can show sensor alerts. See your LHX/SHX user documentation for details.

Important: The LHX/SHX settings are stored on the port where the LHX/SHX device is connected, and are lost if that device is re-connected to a different PX3 port.

For the functionality of this icon  on the top-right corner, see *Feature Port* (on page 193).

► **To view the LHX/SHX device state:**

The Operation State field indicates whether the device is operating fine, and the Switch State field indicates its power status.

If the device does not operate properly, such as some sensor failure, it shows "critical" and the symbol .

► **To turn on or off the LHX/SHX device:**

1. Click the desired power-control button on the top-right corner.

 : Power ON.

 : Power OFF.

2. Confirm the operation on the confirmation message.

► **To configure LHX/SHX settings:**

1. Click Edit Settings.
2. Configure the settings as needed.
 - Provide a customized name.
 - Specify the desired air outlet setpoint temperature.
 - Specify the default fan speed.
3. Click Save.

► **To view all sensor data and configure thresholds:**

1. Locate the Sensors section, which lists all air outlet/inlet temperatures and fan speeds, and indicates the door closed/open status of the LHX/SHX device.
2. To set the thresholds for any temperature or fan speed sensor implemented on the LHX/SHX device:
 - a. Click the desired sensor.
 - b. Click Edit Thresholds.
 - c. Enable and set the desired thresholds and deassertion hysteresis.

Note that assertion timeout is NOT available on LHX/SHX.
 - d. Click Save.
3. After thresholds are enabled, sensors may be highlighted in yellow or red if they enter the warning or critical range. See *Yellow- or Red-Highlighted Sensors* (on page 180).

*Tip: You can also create event rules to notify you of the warning or critical levels. See **Event Rules and Actions** (on page 272).*

► **To view sensor alerts and LHX event log:**

Remote alert acknowledgment is supported by the LHX-20 and LHX-40. The SHX-30 does not support this feature.

1. Locate the Alert States section.
2. If any LHX sensors fail, they are indicated. Click Acknowledge to acknowledge the sensor failure.
3. To view the history of LHX events, click Show Event Log to go to the Event Log page.

► **Operation time statistics:**

This section indicates the accumulative operation hours of the LHX/SHX device and its fans since the device is connected to the PX3 and turned on.

Available time units in the statistics --

- h: hour(s)
- d: day(s)

► **Request maximum cooling:**

Only SHX 30 supports this feature. See ***SHX Request Maximum Cooling*** (on page 206).

SHX Request Maximum Cooling

The PX3 allows you to remotely activate the Schroff SHX 30's maximum cooling feature. Both LHX 20 and LHX 40 do not support remote activation of maximum cooling.

The Request Maximum Cooling feature is available only after the PX3 detects SHX 30. For additional information on the SHX 30 maximum cooling feature, see the SHX 30 documentation.

► **To perform maximum cooling:**

- Go to the SHX page, and click Request Maximum Cooling.
Then the SHX 30 enters into emergency cooling mode and runs at its maximum cooling level of 100% in order to cool the device.
When maximum cooling is requested for an SHX 30, the message "Maximum cooling requested" is displayed.

► **To stop maximum cooling:**

- Click Cancel Maximum Cooling.

Power CIM

After connecting and detecting a Raritan power CIM, the PX3 shows 'Power CIM' in place of 'Feature Port' in the menu. See *Dominion KX II / III Configuration* (on page 696) or *Dominion KSX II, SX or SX II Configuration* (on page 701).

Open the Power CIM page by clicking it in the *Menu* (on page 132). This page shows the CIM's status, including:

- Number of the FEATURE port where this CIM is connected
- Its device type
- Its connection status

For the functionality of this icon  on the top-right corner, see *Feature Port* (on page 193).

User Management

User Management menu deals with user accounts, permissions, and preferred measurement units on a per-user basis.

The PX3 is shipped with one built-in administrator account: **admin**, which is ideal for initial login and system administrator. You can neither delete 'admin' nor change its permissions.

A "role" determines the tasks/actions a user is permitted to perform on the PX3 so you must assign one or multiple roles to each user.



Click 'User Management' in the *Menu* (on page 132), and the following submenu displays.

Submenu command	Refer to...
Users	<i>Creating Users</i> (on page 208)
Roles	<i>Creating Roles</i> (on page 213)
Change Password	<i>Changing Your Password</i> (on page 128)
Preferences	<i>Setting Your Preferred Measurement Units</i> (on page 215)
Default Preferences	<i>Setting Default Measurement Units</i> (on page 216)

Creating Users

All users must have a user account, containing the login name and password. Multiple users can log in simultaneously using the same login name.

To add users, choose User Management > Users > .

Users  			
Enabled ▲	User name	Full Name	Roles
	admin	Administrator	Admin

Note that you must enter information in the fields showing the message 'required.'

required

► **User information:**

Field/setting	Description
User Name	The name the user enters to log in to the PX3. <ul style="list-style-type: none"> ▪ 4 to 32 characters ▪ Case sensitive ▪ Spaces are NOT permitted.
Full Name	The user's first and last names.
Password, Confirm Password	<ul style="list-style-type: none"> ▪ 4 to 64 characters ▪ Case sensitive ▪ Spaces are permitted.
Telephone Number	The user's telephone number
eMail Address	The user's email address <ul style="list-style-type: none"> ▪ Up to 64 characters ▪ Case sensitive
Enable	When selected, the user can log in to the PX3.

Field/setting	Description
Force password change on next login	When selected, a password change request automatically appears when next time the user logs in. For details, see <i>Changing Your Password</i> (on page 128).

► **SSH:**

You need to enter the SSH public key only if the public key authentication for SSH is enabled. See *Changing SSH Settings* (on page 244).

1. Open the SSH public key with a text editor.
2. Copy and paste all content in the text editor into the SSH Public Key field.

► **SNMPv3:**

The SNMPv3 access permission is disabled by default.

Field/setting	Description
Enable SNMPv3	Select this checkbox when intending to permit the SNMPv3 access by this user. <i>Note: The SNMPv3 protocol must be enabled for SNMPv3 access. See Configuring SNMP Settings (on page 241).</i>
Security Level	Click the field to select a preferred security level from the list: <ul style="list-style-type: none"> ▪ None: No authentication and no privacy. This is the default. ▪ Authentication: Authentication and no privacy. ▪ Authentication & Privacy: Authentication and privacy.

- **Authentication Password:** This section is configurable only when 'Authentication' or 'Authentication & Privacy' is selected.

Field/setting	Description
Same as User Password	Select this checkbox if the authentication password is identical to the user's password. To specify a different authentication password, disable the checkbox.

Field/setting	Description
Password, Confirm Password	Type the authentication password if the 'Same as User Password' checkbox is deselected. The password must consist of 8 to 32 ASCII printable characters.

- **Privacy Password:** This section is configurable only when 'Authentication & Privacy' is selected.

Field/setting	Description
Same as Authentication Password	Select this checkbox if the privacy password is identical to the authentication password. To specify a different privacy password, disable the checkbox.
Password, Confirm Password	Type the privacy password if the 'Same as Authentication Password' checkbox is deselected. The password must consist of 8 to 32 ASCII printable characters.

- **Protocol:** This section is configurable only when 'Authentication' or 'Authentication & Privacy' is selected.

Field/setting	Description
Authentication	Click this field to select the desired authentication protocol. Two protocols are available: <ul style="list-style-type: none"> ▪ MD5 ▪ SHA-1 (default)
Privacy	Click this field to select the desired privacy protocol. Two protocols are available: <ul style="list-style-type: none"> ▪ DES (default) ▪ AES-128

► **Preferences:**

This section determines the measurement units displayed in the web interface and command line interface for this user.

Field	Description
Temperature Unit	Preferred units for temperatures -- °C (Celsius) or °F (Fahrenheit).

Field	Description
Length Unit	Preferred units for length or height -- Meter or Feet.
Pressure Unit	Preferred units for pressure -- Pascal or Psi. <ul style="list-style-type: none"> ▪ Pascal = one newton per square meter ▪ Psi = pounds per square inch

*Note: Users can change the measurement units at any time by setting their own preferences. See **Setting Your Preferred Measurement Units** (on page 215).*

► Roles:

Select one or multiple roles to determine the user's permissions. To select all roles, select the top-most checkbox in the header row.

If the built-in roles do not satisfy your needs, add new roles by clicking



. See **Creating Roles** (on page 213).

The Operator role is assigned to a newly-created user account by default.



Built-in role	Description
Admin	Provide full permissions.
Operator	Provide frequently-used permissions, including: <ul style="list-style-type: none"> • Acknowledge Alarms • Change Own Password • Change Pdu, Inlet, Outlet & Overcurrent Protector Configuration • Switch Outlet (if your PX3 is outlet-switching capable) • View Event Settings • View Local Event Log

Note: With multiple roles selected, a user has the union of all roles' permissions.

Editing or Deleting Users

To edit or delete users, choose User Management > Users to open the Users page, which lists all users.

In the Enabled column:

- : The user is enabled.
- : The user is disabled.

If wanted, you can resort the list by clicking the desired column header. See *Sorting a List* (on page 134).

▶ **To edit or delete a user account:**

1. On the Users page, click the desired user. The Edit User page for that user opens.
2. Make changes as needed.
 - For information on each field, see *Creating Users* (on page 208).
 - To change the password, type a new password in the Password and Confirm Password fields. If the password field is left blank, the password remains unchanged.
 - To delete this user, click , and confirm the operation.
3. Click Save.

▶ **To delete multiple user accounts:**

1. On the Users page, click  to make checkboxes appear in front of user names.

Tip: To delete only one user, you can simply click that user without making the checkboxes appear. See the above procedure.

2. Select one or multiple users.
 - To select all roles, except for the admin role, select the top-most checkbox in the header row.
3. Click .
4. Click Delete on the confirmation message.

Creating Roles

A role is a combination of permissions. Each user must have at least one role.



The PX3 provides two built-in roles. The Operator role is assigned to a newly-created user account per default. See *Creating Users* (on page 208).

Built-in role	Description
Admin	Provide full permissions.
Operator	Provide frequently-used permissions, including: <ul style="list-style-type: none"> • Acknowledge Alarms • Change Own Password • Change Pdu, Inlet, Outlet & Overcurrent Protector Configuration • Switch Outlet (if your PX3 is outlet-switching capable) • View Event Settings • View Local Event Log

If the two do not satisfy your needs, add new roles.

► To create a role:

1. Choose User Management > Roles > .

Roles		 
Role Name ▲	Description	
Admin	System defined administrator role including all privileges.	
Operator	Predefined operator role.	

2. Assign a role name.
 - 1 to 32 characters long
 - Case sensitive
 - Spaces are permitted as of release 3.3.0
3. Type a description for the role in the Description field.
4. Select the desired privilege(s).
 - The 'Administrator Privileges' includes all privileges.
 - The 'Unrestricted View Privileges' includes all 'View' privileges.

5. To select any privilege requiring the argument setting, click  to select the desired arguments.
 - For example, on an outlet-switching capable model, you can specify the outlets that are allowed to be switched on/off for the 'Switch Outlet' privilege as shown below.

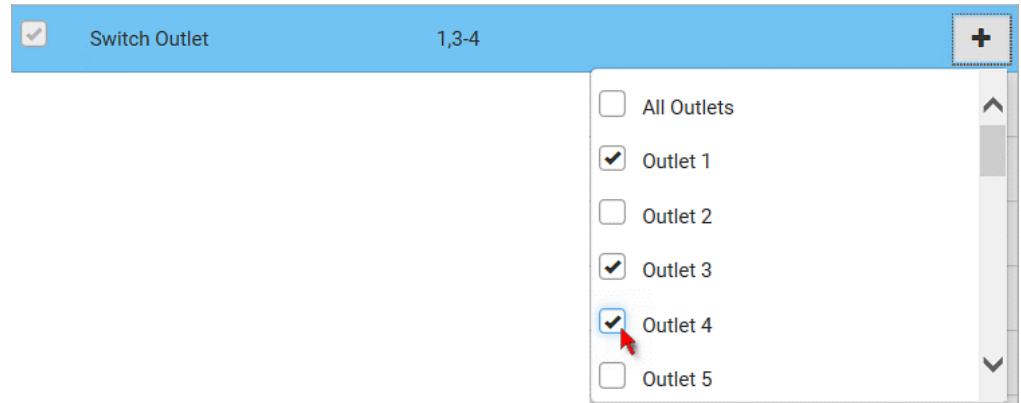

6. Click Save.

Now you can assign the role to any user. See *Creating Users* (on page 208) or *Editing or Deleting Users* (on page 212).

Editing or Deleting Roles

Choose User Management > Roles to open the Roles page, which lists all roles.

If wanted, you can resort the list by clicking the desired column header. See *Sorting a List* (on page 134).

The Admin role is not user-configurable so the lock icon  displays, indicating that you are not allowed to configure it.

► To edit a role:

1. On the Roles page, click the desired role. The Edit Role page opens.
2. Make changes as needed.
 - The role name cannot be changed.
 - To delete this role, click , and confirm the operation.
3. Click Save.

► To delete any roles:

1. On the Roles page, click  to make checkboxes appear in front of roles.

Tip: To delete only one role, you can simply click that user without making the checkboxes appear. See the above procedure.

2. Select one or multiple roles.
 - To select all roles, except for the Admin role, select the top-most checkbox in the header row.
3. Click  on the top-right corner.
4. Click Delete on the confirmation message.

Setting Your Preferred Measurement Units

You can change the measurement units shown in the PX3 user interface according to your own preferences regardless of the permissions you have.

*Tip: Preferences can also be changed by administrators for specific users on the Edit User page. See **Editing or Deleting Users** (on page 212).*

Measurement unit changes only apply to the web interface and command line interface.

Setting your own preferences does not change the default measurement units. See **Setting Default Measurement Units** (on page 216).

► **To select the measurement units you prefer:**

1. Choose User Management > Preferences.
2. Make changes as needed.

Field	Description
Temperature Unit	Preferred units for temperatures -- °C (Celsius) or °F (Fahrenheit).
Length Unit	Preferred units for length or height -- Meter or Feet.
Pressure Unit	Preferred units for pressure -- Pascal or Psi. <ul style="list-style-type: none"> ▪ Pascal = one newton per square meter ▪ Psi = pounds per square inch

3. Click Save.

Setting Default Measurement Units

Default measurement units are applied to all PX3 user interfaces across all users, including users accessing the PX3 via external authentication servers. For a list of affected user interfaces, see *User Interfaces Showing Default Units* (on page 216). The front panel display also shows the default measurement units.

*Note: The preferred measurement units set by any individual user or by the administrator on a per-user basis will override the default units in the web interface and command line interface. See **Setting Your Preferred Measurement Units** (on page 215) or **Creating Users** (on page 208).*

► **To set up default user preferences:**

1. Click User Management > Default Preferences.
2. Make changes as needed.

Field	Description
Temperature Unit	Preferred units for temperatures -- °C (Celsius) or °F (Fahrenheit).
Length Unit	Preferred units for length or height -- Meter or Feet.
Pressure Unit	Preferred units for pressure -- Pascal or Psi. <ul style="list-style-type: none"> ▪ Pascal = one newton per square meter ▪ Psi = pounds per square inch

3. Click Save.

User Interfaces Showing Default Units

Default measurement units will apply to the following user interfaces or information:

- Web interface for "newly-created" local users when they have not configured their own preferred measurement units. See *Creating Users* (on page 208).
- Web interface for users who are authenticated via LDAP/Radius servers.
- The sensor report sent because of the "Send Sensor Report" action. See *Send Sensor Report* (on page 297).
- Front panel LCD display.

Device Settings

Click 'Device Settings' in the *Menu* (on page 132), and the following submenu displays.

Menu command	Submenu command	Refer to...
Network		<i>Configuring Network Settings</i> (on page 218)
Network Services	HTTP	<i>Changing HTTP(S) Settings</i> (on page 240)
	SNMP	<i>Configuring SNMP Settings</i> (on page 241)
	SMTP Server	<i>Configuring SMTP Settings</i> (on page 242)
	SSH	<i>Changing SSH Settings</i> (on page 244)
	Telnet	<i>Changing Telnet Settings</i> (on page 244)
	Modbus	<i>Changing Modbus Settings</i> (on page 245)
	Server Advertising	<i>Enabling Service Advertising</i> (on page 246)
Security	IP Access Control	<i>Creating IP Access Control Rules</i> (on page 247)
	Role Access Control	<i>Creating Role Access Control Rules</i> (on page 250)
	SSL Certificate	<i>Setting Up an SSL/TLS Certificate</i> (on page 252)
	Authentication	<i>Setting Up External Authentication</i> (on page 257)
	Login Settings	<i>Configuring Login Settings</i> (on page 266)
	Password Policy	<i>Configuring Password Policy</i> (on page 267)
	Service Agreement	<i>Enabling the Restricted Service Agreement</i> (on page 268)
Date/Time		<i>Setting the Date and Time</i> (on page 269)
Event Rules		<i>Event Rules and Actions</i> (on page 272)
Data Logging		<i>Setting Data Logging</i> (on page 317)
Data Push		<i>Configuring Data Push Settings</i> (on page 318)
Server Reachability		<i>Monitoring Server Accessibility</i> (on page 320)
Front Panel*		<i>Front Panel Settings</i> (on page 324)
Serial Port		<i>Configuring the Serial Port</i> (on page 325)
Lua Scripts		<i>Lua Scripts</i> (on page 327)
Miscellaneous		<i>Miscellaneous</i> (on page 332)

* The availability of "Front Panel" depends on the model.

Configuring Network Settings

Configure wired, wireless, and Internet protocol-related settings on the Network page after *connecting the PX3 to your network* (on page 24).

You can enable both the wired and wireless networking on the PX3 so that it has multiple IP addresses -- wired and wireless IP. For example, you can obtain one IPv4 and/or IPv6 address by enabling one Ethernet interface, and obtain one more IPv4 and/or IPv6 address by enabling/configuring the wireless interface. This also applies when the PX3 enters the port forwarding mode so that the PX3 has more than one IPv4 or IPv6 address in the port forwarding mode.

However, the PX3 in the BRIDGING mode obtains "only one" IP address for wired networking. Wireless networking is NOT supported in this mode.

Important: In the bridging mode, only the IP parameters of the BRIDGE interface function. The IP parameters of the ETHERNET (or ETH1/ETH2) and WIRELESS interfaces do NOT function.

► **To set up the network settings:**

1. Choose Device Settings > Network.
2. To use DHCP-assigned DNS servers and gateway instead of static ones, go to step 3. To manually specify DNS servers and default gateway, configure the Common Network Settings section. See *Common Network Settings* (on page 220).
 - Static routes and cascading mode are in this section. You need to configure them only when there are such local requirements. See *Setting the Cascading Mode* (on page 231) and *Static Route Examples* (on page 227).
3. To configure IPv4/IPv6 settings for a *wired* network, click the ETHERNET (or ETH1/ETH2) or BRIDGE section. See *Wired Network Settings* (on page 219).
 - If the device's cascading mode is set to 'Bridging', the BRIDGE section appears. Then you must click the BRIDGE section for IPv4/IPv6 settings.
4. To configure IPv4/IPv6 settings for a *wireless* network, click the WIRELESS section. See *Wireless Network Settings* (on page 222).
 - You must connect a USB wireless LAN adapter to the PX3 for wireless networking.

Note: If the device's cascading mode is set to 'Bridging' or its role is set to 'Slave' in the port forwarding mode, the wireless settings will be disabled.

5. To configure the ETHERNET (or ETH1/ETH2) interface settings, see ***Ethernet Interface Settings*** (on page 221).
6. Click Save.

► **After enabling either or both Internet protocols:**

After enabling IPv4 and/or IPv6, all but not limited to the following protocols will be compliant with the selected Internet protocol(s):

- LDAP
- NTP
- SMTP
- SSH
- Telnet
- FTP
- SSL/TLS
- SNMP
- SysLog

Note: The PX3 supports TLS 1.0, 1.1 and 1.2.

Wired Network Settings

On the Network page, click the ETHERNET (or ETH1/ETH2) section to configure IPv4/IPv6 settings.

If the device's cascading mode is set to 'Bridging', the BRIDGE section appears. Then you must click the BRIDGE section for IPv4/IPv6 settings. See ***Setting the Cascading Mode*** (on page 231).

► **Enable Interface:**

Make sure the Ethernet interface is enabled, or all networking through this interface fails. This setting is available in the ETHERNET (or ETH1/ETH2) section, but not available in the BRIDGE section.

Enable Interface



► **IPv4 settings:**

Field/setting	Description
Enable IPv4	Enable or disable the IPv4 protocol.

Field/setting	Description
IP Auto Configuration	Select the method to configure IPv4 settings. <ul style="list-style-type: none"> ▪ DHCP: Auto-configure IPv4 settings via DHCP servers. ▪ Static: Manually configure the IPv4 settings.

- **DHCP settings:** Optionally specify the preferred hostname, which must meet the following requirements:
 - Consists of alphanumeric characters and/or hyphens
 - Cannot begin or end with a hyphen
 - Cannot contain more than 63 characters
 - Cannot contain punctuation marks, spaces, and other symbols
- **Static settings:** Assign a static IPv4 address, which follows this syntax "IP address/prefix length".
Example: *192.168.84.99/24*

► **IPv6 settings:**

Field/setting	Description
Enable IPv6	Enable or disable the IPv6 protocol.
IP Auto Configuration	Select the method to configure IPv6 settings. <ul style="list-style-type: none"> ▪ Automatic: Auto-configure IPv6 settings via DHCPv6. ▪ Static: Manually configure the IPv6 settings.

- **Automatic settings:** Optionally specify the preferred hostname, which must meet the above requirements.
- **Static settings:** Assign a static IPv6 address, which follows this syntax "IP address/prefix length".
Example: *fd07:2fa:6cff:1111::0/128*

Common Network Settings

Common Network Settings are OPTIONAL, not required. Therefore, leave them unchanged if there are no specific local networking requirements.

Field	Description
Cascading Mode	Leave it to the default "None" unless you are establishing a cascading chain. For more information, refer to:

Field	Description
	<ul style="list-style-type: none"> ▪ <i>Cascading Multiple PX3 Devices for Sharing Ethernet Connectivity</i> (on page 38) ▪ <i>Setting the Cascading Mode</i> (on page 231)
DNS Resolver Reference	<p>Determine which IP address is used when the DNS resolver returns both IPv4 and IPv6 addresses.</p> <ul style="list-style-type: none"> ▪ IPv4 Address: Use the IPv4 addresses. ▪ IPv6 Address: Use the IPv6 addresses.
DNS Suffixes (optional)	Specify a DNS suffix name if needed.
First/Second/Third DNS Server	<p>Manually specify static DNS server(s).</p> <ul style="list-style-type: none"> ▪ If any static DNS server is specified in these fields, it will override the DHCP-assigned DNS server. ▪ If DHCP (or Automatic) is selected for IPv4/IPv6 settings, and there are NO static DNS servers specified, the PX3 will use DHCP-assigned DNS servers.
IPv4/IPv6 Routes	<p>You need to configure these settings only when your local network contains two subnets, and you want PX3 to communicate with the other subnet. If so, make sure IP forwarding has been enabled in your network, and then you can click 'Add Route' to add static routes.</p> <p>See <i>Static Route Examples</i> (on page 227).</p>

Ethernet Interface Settings

By default the Ethernet interface or ETH1/ETH2 interface for iX7™ is enabled.

► Enable Interface:

Make sure the Ethernet interface is enabled, or all networking through this interface fails. This setting is available in the ETHERNET (or ETH1/ETH2) section, but not available in the BRIDGE section.

Enable Interface



► **Other Ethernet settings:**

Field	Description
Speed	Select a LAN speed. <ul style="list-style-type: none"> • Auto: System determines the optimum LAN speed through auto-negotiation. • 10 MBit/s: Speed is always 10 Mbps. • 100 MBit/s: Speed is always 100 Mbps. • 1 GBit/s: Speed is always 1 Gbps (1000 Mbps). Available only for PX3-iX7 or specific PX3 models with the suffix "-G1".
Duplex	Select a duplex mode. <ul style="list-style-type: none"> • Auto: The PX3 selects the optimum transmission mode through auto-negotiation. • Full: Data is transmitted in both directions simultaneously. • Half: Data is transmitted in one direction (to or from the PX3 device) at a time.
Current State	Show the LAN's current status, including the current speed and duplex mode.

Note: Auto-negotiation is disabled after setting both the speed and duplex settings of the PX3 to NON-Auto values, which may result in a duplex mismatch.

Wireless Network Settings

If the device's cascading mode is set to 'Bridging' or its role is set to 'Slave' in the port forwarding mode, the wireless settings will be disabled. See ***Setting the Cascading Mode*** (on page 231).

By default the wireless interface is disabled. You should enable it if wireless networking is wanted.

► **Interface Settings:**

Field/setting	Description
Enable Interface	Enable or disable the wireless interface. When disabled, the wireless networking fails.
Hardware State	Check this field to ensure that the PX3 device has detected a wireless USB LAN adapter. If not, verify whether the USB LAN adapter is firmly

Field/setting	Description
	connected or whether it is supported.
SSID	Type the name of the wireless access point (AP)
Force AP BSSID	If the BSSID is available, select this checkbox
BSSID	Type the MAC address of an access point
Enable High Throughput (802.11n)	Enable or disable 802.11n protocol.
Authentication	Select an authentication method. <ul style="list-style-type: none"> No Authentication: No authentication data is required. PSK: A Pre-Shared Key is required. EAP - PEAP: Use Protected Extensible Authentication Protocol. Only MSCHAPv2 is supported. Enter required authentication data in the fields that appear.
Pre-Shared Key	This field appears only when PSK is selected. Type the PSK string
Identity	This field appears only when 'EAP - PEAP' is selected. Type your user name.
Password	This field appears only when 'EAP - PEAP' is selected. Type your password.
CA Certificate	This field appears only when 'EAP - PEAP' is selected. A third-party CA certificate may or may not be needed. If needed, follow the steps below.

- Available settings for the CA Certificate:

Field/setting	Description
Enable verification of TLS certificate chain	<p>Select this checkbox for the PX3 to verify the validity of the TLS certificate that will be installed.</p> <ul style="list-style-type: none"> ▪ For example, the PX3 will check the certificate's validity period against the system time.
	<p>Click this button to install a certificate file. Then you can:</p> <ul style="list-style-type: none"> ▪ Click Show to view the certificate's content. ▪ Click Remove to delete the installed certificate if it is inappropriate.
Allow expired and not yet valid certificates	<ul style="list-style-type: none"> ▪ Select this checkbox to make the authentication succeed regardless of the certificate's validity period. ▪ After deselecting this checkbox, the authentication fails whenever any certificate in the selected certificate chain is outdated or not valid yet.
Allow wireless connection if system clock is incorrect	<p>When this checkbox is deselected, and if the system time is incorrect, the installed TLS certificate is considered not valid yet and will cause the wireless network connection to fail.</p> <p>When this checkbox is selected, it will make the wireless network connection successful when the PX3 system time is earlier than the firmware build before synchronizing with any NTP server.</p> <ul style="list-style-type: none"> ▪ The incorrect system time issue may occur when the PX3 has once been powered off for a long time.

► IPv4 settings:

Field/setting	Description
Enable IPv4	Enable or disable the IPv4 protocol.
IP Auto Configuration	<p>Select the method to configure IPv4 settings.</p> <ul style="list-style-type: none"> ▪ DHCP: Auto-configure IPv4 settings via DHCP servers. ▪ Static: Manually configure the IPv4 settings.

- **DHCP settings:** Optionally specify the preferred hostname, which must meet the following requirements:
 - Consists of alphanumeric characters and/or hyphens
 - Cannot begin or end with a hyphen
 - Cannot contain more than 63 characters
 - Cannot contain punctuation marks, spaces, and other symbols
- **Static settings:** Assign a static IPv4 address, which follows this syntax "IP address/prefix length".
Example: *192.168.84.99/24*

▶ **IPv6 settings:**

Field/setting	Description
Enable IPv6	Enable or disable the IPv6 protocol.
IP Auto Configuration	Select the method to configure IPv6 settings. <ul style="list-style-type: none"> ▪ Automatic: Auto-configure IPv6 settings via DHCPv6. ▪ Static: Manually configure the IPv6 settings.

- **Automatic settings:** Optionally specify the preferred hostname, which must meet the above requirements.
- **Static settings:** Assign a static IPv6 address, which follows this syntax "IP address/prefix length".
Example: *fd07:2fa:6cff:1111::0/128*

▶ **[Optional] To view the wireless LAN diagnostic log:**

- Click Show WLAN Diagnostic Log. See *Wireless LAN Diagnostic Log* (on page 226).

Wireless LAN Diagnostic Log

The PX3 provides a diagnostic log for inspecting connection errors that occurred over the wireless network interface. The information is useful for technical support.

Note that the WLAN Diagnostic Log shows data only after the Network Interface is set to Wireless.

Each entry in the log consists of:

- ID number
- Date and time
- Description

► **To view the log:**



1. Choose Device Settings > Network > WIRELESS > Show WLAN Diagnostic Log. See *Configuring Network Settings* (on page 218).
2. To go to other pages of the log, click the pagination bar at the bottom of the page.
 - If there are more than 5 pages and the page numbers displayed

in the bar does not show the desired one, click  to have it show the next or previous five page numbers, if available.



3. To refresh the diagnostic, click  **Refresh** on the top-right corner.
4. If wanted, you can resort the list by clicking the desired column header. See *Sorting a List* (on page 134).

► **To clear the diagnostic log:**

1. On the top-right corner of the log, click  >  **Clear Log**.
2. Click Clear Log on the confirmation message.

Static Route Examples

This section describes two static route examples: IPv4 and IPv6. Both examples assume that two network interface controllers (NIC) have been installed in one network server, leading to two available subnets, and IP forwarding has been enabled. All of the NICs and PX3 devices in the examples use static IP addresses.

Most of local multiple networks are not directly reachable and require the use of a gateway. Therefore, we will select Gateway in the following examples. If your local multiple networks are directly reachable, you should select Interface rather than Gateway.

*Note: If Interface is selected, you should select an interface name instead of entering an IP address. See **Interface Names** (on page 230).*

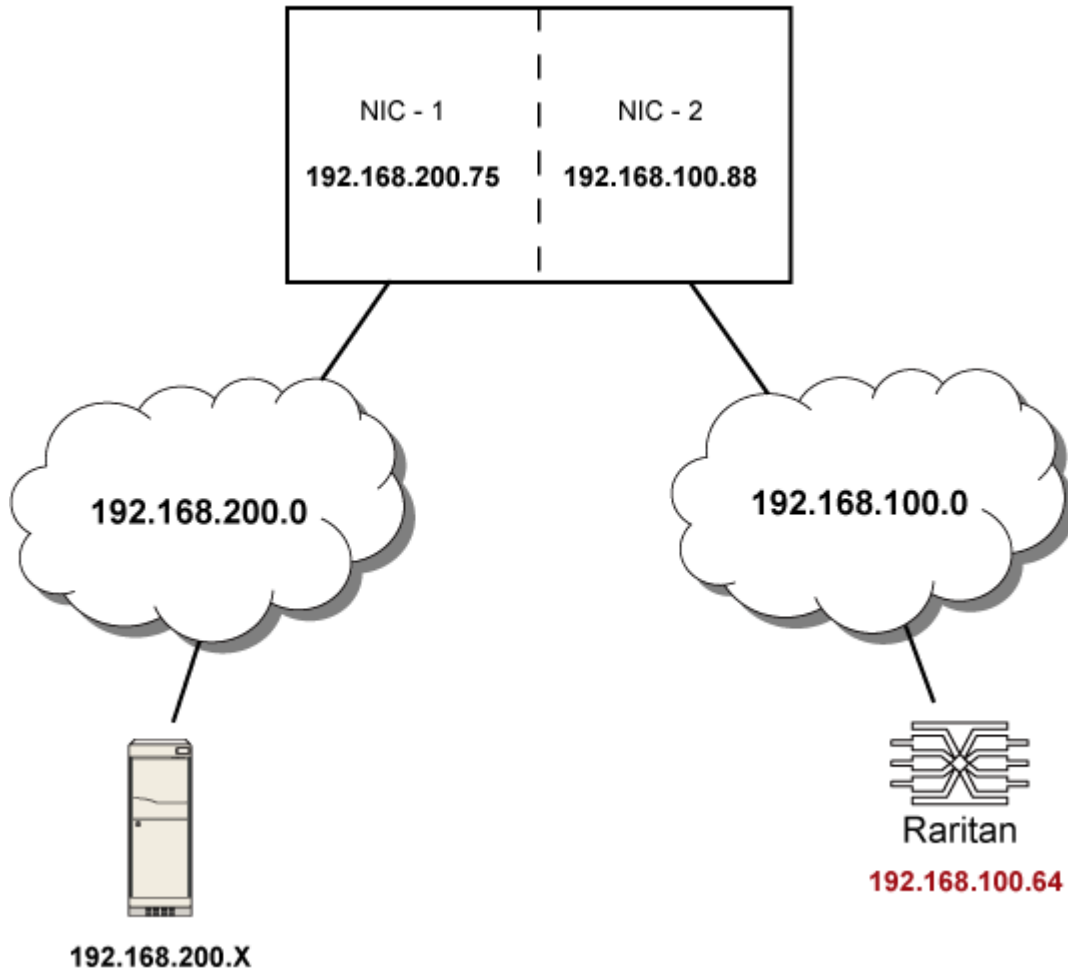

▶ **IPv4 example:**

- Your PX3: *192.168.100.64*
- Two NICs: *192.168.200.75* and *192.168.100.88*
- Two networks: *192.168.200.0* and *192.168.100.0*
- Subnet mask: *24*



In this example, NIC-2 (192.168.100.88) is the next hop router for your PX3 to communicate with any device in the other subnet 192.168.200.0. In the IPv4 "Static Routes" section, you should specify:

1	192.168.200.0/24	Gateway	▼	192.168.100.88	↑	↓	🗑️
---	------------------	---------	---	----------------	---	---	----



Tip: If you have configured multiple static routes, you can click on any route and then make changes, use  or  to re-sort the priority, or click  to delete it.

► **IPv6 example:**

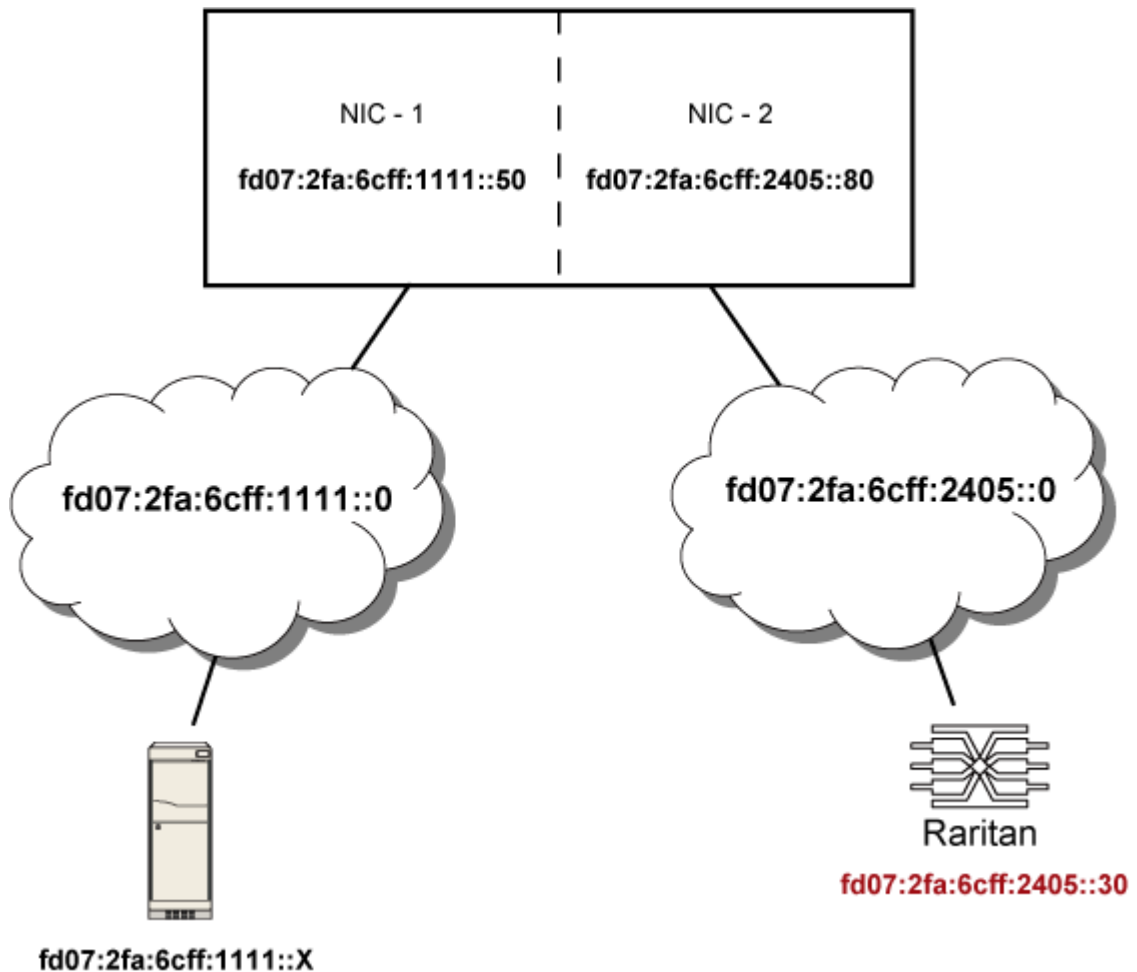
- Your PX3: `fd07:2fa:6cff:2405::30`
- Two NICs: `fd07:2fa:6cff:1111::50` and `fd07:2fa:6cff:2405::80`
- Two networks: `fd07:2fa:6cff:1111::0` and `fd07:2fa:6cff:2405::0`
- Prefix length: 64



In this example, NIC-2 (fd07:2fa:6cff:2405::80) is the next hop router for your PX3 to communicate with any device in the other subnet fd07:2fa:6cff:1111::0. In the IPv6 "Static Routes" section, you should specify:

Tip: If you have configured multiple static routes, you can click on any route and then make changes, use  or  to re-sort the priority, or click  to delete it.

Interface Names

When your local multiple networks are "directly reachable", you should select Interface for static routes. Then choose the interface where another network is connected.

► **Interface list for PX3:**

Interface name	Description
BRIDGE	When another wired network is connected to the Ethernet port of your PX3, and your PX3 has been set to the bridging mode, select this interface name instead of the Ethernet interface.
ETHERNET	When another wired network is connected to the Ethernet port of your PX3, select this interface name.
WIRELESS	When another wireless network is connected to your PX3, select this interface name.

► **Interface list for PX3-iX7:**

Interface name	Description
BRIDGE	When another wired network is connected to the Ethernet port of your PX3, and your PX3 has been

Interface name	Description
	set to the bridging mode, select this interface name instead of the Ethernet interface.
ETH1	When another wired network is connected to the ETH1 port of your PX3, select this interface name.
ETH2	When another wired network is connected to the ETH2 port of your PX3, select this interface name.
WIRELESS	When another wireless network is connected to your PX3, select this interface name.

Setting the Cascading Mode

A maximum of 16 PX3 devices can be cascaded to share one Ethernet connection. See *Cascading Multiple PX3 Devices for Sharing Ethernet Connectivity* (on page 38).

The cascading mode configured on the master device determines the Ethernet sharing method, which is either network bridging or port forwarding. See *Overview of the Cascading Modes* (on page 233).

Only a user with the Change Network Settings can configure the cascading mode.

*Note: The PX3 in the Port Forwarding mode does not support APIPA. See **APIPA and Link-Local Addressing** (on page 3).*

► To configure the cascading mode:

1. Connect the device that you will cascade to the LAN and find its IP address, or connect it to a computer.
 - For the computer connection instructions, see *Connecting the PX3 to a Computer* (on page 28).
 - To find the IP address, see *Device Info* (on page 111).
2. Log in to its web interface.
3. Choose Device Settings > Network.
4. Select the preferred mode in the Cascading Mode field.
 - None: No cascading mode is enabled. This is the default.
 - Bridging: Each device in the cascading chain is accessed with a different IP address.

- Port Forwarding: Each device in the cascading chain is accessed with the same IP address but with a different port number assigned. For details on port numbers, see *Port Number Syntax* (on page 234).

Tip: If selecting Port Forwarding, the Device Information page will show a list of port numbers for all cascaded devices.

5. For the port forwarding mode, one to two more fields have to be configured. Note that if either setting is incorrectly configured, a networking issue occurs.
 - Role: Master or Slave. This is to determine which device is the master and which ones are slave devices.
 - Downstream interface: USB or Ethernet (or ETH1/ETH2). This is to determine which port of the master device is connected to Slave 1. Always select USB for PX3, but you can select either USB or Ethernet (ETH1/ETH2) for PX3-iX7 models.

If Ethernet (ETH1/ETH2) is selected as the downstream interface, make sure the selected Ethernet interface is enabled.

6. Now you can configure the network settings.
 - Bridging mode: Click the BRIDGE section on the same page.
 - Port forwarding mode: Click the ETHERNET (or ETH1/ETH2) or WIRELESS section on the same page, depending on the networking method you prefer.
7. Click Save.

For information on accessing each cascaded device in the Port Forwarding mode, see *Port Forwarding Examples* (on page 236).

For information on wired or wireless network settings, see *Wired Network Settings* (on page 219) or *Wireless Network Settings* (on page 222).

Special application: You can "loop" a cascading chain to create network communication redundancy (bridging mode only), but only when your network supports R/STP protocol. Make sure that your network has R/STP enabled if using a cascade loop (bridging mode) or else network loops may occur.

► **Online USB-cascading information:**

For more information on the USB-cascading configuration, see the *Cascading Guide*, which is available from Raritan website's *Support page* (<http://www.raritan.com/support/>).

Overview of the Cascading Modes

You must apply a cascading mode to the cascading configuration. See *Setting the Cascading Mode* (on page 231).

► Overview:

- The Bridging mode supports the wired network only, while the Port Forwarding mode supports both wired and wireless networks.
- All cascading modes support a maximum of 16 devices in a chain.
- All cascading modes support both DHCP and static IP addressing.
- In the Bridging mode, each cascaded device has a unique IP address. In the Port Forwarding mode, all cascaded devices share the same IP address.
- Each cascaded device can be remotely accessed through the network regardless of the cascading mode.

► Illustration:

In the following diagrams, it is assumed that users enable the DHCP networking in the cascading configuration comprising four devices. "M" is the master device and "S" is the slave device.

• "Bridging" mode:

In this mode, the DHCP server communicates with every cascaded device respectively and assigns four *different* IP addresses. Each device has its own IP address. The way to remotely access each cascaded device is completely the same as accessing a standalone device in the network.

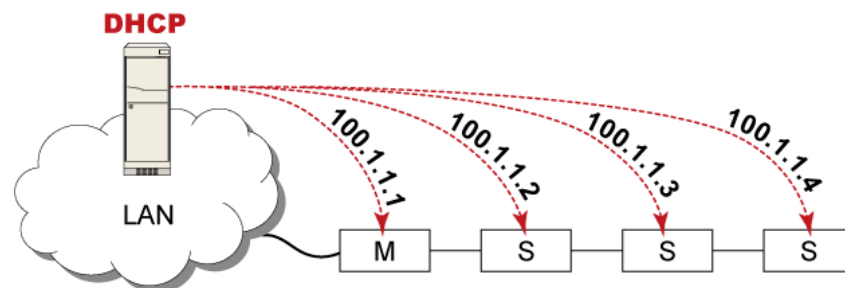

- **"Port Forwarding" mode:**

In this mode, the DHCP server communicates with the master device alone and assigns only one IP address. All slave devices share the same IP address as the master device. You must specify a 5XXXX port number (where X is a number) when remotely accessing any slave device via the shared IP address. See *Port Number Syntax* (on page 234).

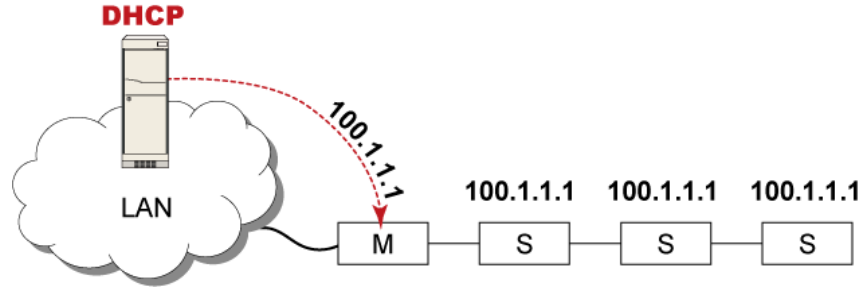

Port Number Syntax

In the Port Forwarding mode, all devices in the USB-cascading configuration share the same IP address. To access any cascaded device, you must assign an appropriate port number to it.

- Master device: The port number is either 5NNXX or the standard TCP/UDP port.
- Slave device: The port number is 5NNXX.

► **5NNXX port number syntax:**

- NN is a two-digit number representing the network protocol as shown below:

Protocols	NN
HTTPS	00
HTTP	01
SSH	02
TELNET	03
SNMP	05
MODBUS	06

- XX is a two-digit number representing the device position as shown below.

The following table only lists 7 slave devices, but the port forwarding supports up to 15 slave devices.

Position	XX
Master device	00
Slave 1	01
Slave 2	02
Slave 3	03
Slave 4	04
Slave 5	05
Slave 6	06
Slave 7	07

For example, to access the Slave 4 device via Modbus/TCP, the port number is 50604. See **Port Forwarding Examples** (on page 236) for further illustrations.

Tip: The full list of each cascaded device's port numbers can be retrieved from the web interface. Choose Maintenance > Device Information > Port Forwarding.

► **Standard TCP/UDP ports:**

The master device can be also accessed through standard TCP/UDP ports as listed in the following table.

Protocols	Port Numbers
HTTPS	443
HTTP	80
SSH	22
TELNET	23
SNMP	161
MODBUS	502

In the Port Forwarding mode, the PX3 does NOT allow you to modify the standard TCP/UDP port configuration, including HTTP, HTTPS, SSH, Telnet and Modbus/TCP.

Port Forwarding Examples

To access a cascaded device in the Port Forwarding mode, assign a port number to the IP address.

- Master device: Assign proper 5NNXX port numbers or standard TCP/UDP ports. See **Port Number Syntax** (on page 234) for details.
- Slave device: Assign proper 5NNXX port numbers.

Assumption: *The Port Forwarding mode is applied to a USB-cascading configuration comprising three Raritan devices. The IP address is 192.168.84.77.*

► **Master device:**

Position code for the master device is '00' so each port number is 5NN00 as listed below.

Protocols	Port numbers
HTTPS	50000
HTTP	50100
SSH	50200
TELNET	50300
SNMP	50500
MODBUS	50600

Examples using "5NN00" ports:

- To access the master device via HTTPS, the IP address is:
https://192.168.84.77:50000/
- To access the master device via HTTP, the IP address is:
http://192.168.84.77:50100/
- To access the master device via SSH, the command is:
ssh -p 50200 192.168.84.77

Examples using standard TCP/UDP ports:

- To access the master device via HTTPS, the IP address is:
https://192.168.84.77:443/
- To access the master device via HTTP, the IP address is:
http://192.168.84.77:80/
- To access the master device via SSH, the command is:
ssh -p 22 192.168.84.77

► **Slave 1 device:**

Position code for Slave 1 is '01' so each port number is 5NN01 as shown below.

Protocols	Port numbers
HTTPS	50001
HTTP	50101
SSH	50201
TELNET	50301
SNMP	50501
MODBUS	50601

Examples:

- To access Slave 1 via HTTPS, the IP address is:
https://192.168.84.77:50001/
- To access Slave 1 via HTTP, the IP address is:
http://192.168.84.77:50101/
- To access Slave 1 via SSH, the command is:
ssh -p 50201 192.168.84.77

► **Slave 2 device:**

Position code for Slave 2 is '02' so each port number is 5NN02 as shown below.

Protocols	Port numbers
HTTPS	50002
HTTP	50102
SSH	50202
TELNET	50302
SNMP	50502
MODBUS	50602

Examples:

- To access Slave 2 via HTTPS, the IP address is:
https://192.168.84.77:50002/

- To access Slave 2 via HTTP, the IP address is:

`http://192.168.84.77:50102/`

- To access Slave 2 via SSH, the command is:

`ssh -p 50202 192.168.84.77`

Adding, Removing or Swapping Cascaded Devices

Change the cascading mode first before adding any device to a cascading chain, or before disconnecting a cascaded device from the chain.

If you only want to change the cascading mode of an existing chain, or swap the master and slave device, always start from the slave device.

*Note: If the following procedures are not followed, a networking issue occurs. When a networking issue occurs, check the cascading connection and/or software settings of all devices in the chain. See **Cascading Troubleshooting** (on page 688).*

▶ To add a device to an existing chain:

1. Connect the device that you will cascade to the LAN and find its IP address, or connect it to a computer.
2. Log in to this device and set its cascading mode to be the same as the existing chain's cascading mode. See **Setting the Cascading Mode** (on page 231).
3. Connect it to the chain, using either USB or Ethernet cable.

▶ To remove a device from the chain:

1. Log in to the desired cascaded device, and change its cascading mode to None.

Exception: If you are going to connect the removed device to another cascading chain, set its cascading mode to be the same as the cascading mode of another chain.

2. Now disconnect it from the cascading chain.

▶ To swap the master and slave device:

- In the bridging mode, you can swap the master and slave devices by simply disconnecting ALL cascading cables from them, and then reconnecting cascading cables. No changes to software settings are required.
- In the port forwarding mode, you must follow the procedure below:
 - a. Access the slave device that will replace the master device, and set its role to 'Master', and correctly set the downstream interface.
 - b. Access the master device, set its role to 'Slave'.

- c. Swap the master and slave device now. You must disconnect ALL cascading cables connected to the two devices first before swapping them and reconnecting cascading cables.

► **To change the cascading mode applied to a chain:**

1. Access the last slave device, and change its cascading mode.
 - If the new cascading mode is 'Port Forwarding', you must also set its role to 'Slave'.
2. Access the second to last, third to last and so on until the first slave device to change their cascading modes one by one.
3. Access the master device, and change its cascading mode.
 - If the new cascading mode is 'Port Forwarding', you must also set its role to 'Master', and correctly select the downstream interface.

Configuring Network Services

The PX3 supports the following network communication services.

HTTPS and HTTP enable the access to the web interface. Telnet and SSH enable the access to the command line interface. See *Using the Command Line Interface* (on page 365).

By default, SSH is enabled, Telnet is disabled, and all TCP ports for supported services are set to standard ports. You can change default settings if necessary.

Note: Telnet access is disabled by default because it communicates openly and is thus insecure.

Submenu command	Refer to
HTTP	<i>Changing HTTP(S) Settings</i> (on page 240)
SNMP	<i>Configuring SNMP Settings</i> (on page 241)
SMTP Server	<i>Configuring SMTP Settings</i> (on page 242)
SSH	<i>Changing SSH Settings</i> (on page 244)
Telnet	<i>Changing Telnet Settings</i> (on page 244)
Modbus	<i>Changing Modbus Settings</i> (on page 245)
Service Advertising	<i>Enabling Service Advertising</i> (on page 246)

Important: Raritan uses TLS instead of SSL 3.0 due to published security vulnerabilities in SSL 3.0. Make sure your network infrastructure, such as LDAP and mail services, uses TLS rather than SSL 3.0.

Changing HTTP(S) Settings

HTTPS uses Transport Layer Security (TLS) technology to encrypt all traffic to and from the PX3 so it is a more secure protocol than HTTP. The PX3 supports TLS 1.0, 1.1 and 1.2.

By default, any access to the PX3 via HTTP is automatically redirected to HTTPS. You can disable this redirection if needed.

► **To change HTTP or HTTPS port settings:**

1. Choose Device Settings > Network Services > HTTP.
2. Enable either or both protocols by selecting the corresponding 'Enable' checkbox.
3. To use a different port for HTTP or HTTPS, type a new port number.

Warning: Different network services cannot share the same TCP port.

4. To redirect the HTTP access to the PX3 to HTTPS, select the "Redirect HTTP connections to HTTPS."
 - The redirection checkbox is configurable only when both HTTP and HTTPS have been enabled.

Special note for AES ciphers:

The PX3 device's SSL/TLS-based protocols, including HTTPS, support AES 128- and 256-bit ciphers. The exact cipher to use is negotiated between the PX3 and the client (such as a web browser), which is impacted by the cipher priority of the PX3 and the client's cipher availability/settings.

Tip: If intending to force the PX3 to use a specific AES cipher, refer to your client's user documentation for information on configuring AES settings. For example, you can enable a cipher and disable the other in the Firefox via the "about:config" command.

Configuring SNMP Settings

You can enable or disable SNMP communication between an SNMP manager and the PX3 device. Enabling SNMP communication allows the manager to retrieve and even control the power status of each outlet.

Besides, you may need to configure the SNMP destination(s) if the built-in "System SNMP Notification Rule" is enabled and the SNMP destination has not been set yet. See *Event Rules and Actions* (on page 272).

► To configure SNMP communication:

1. Choose Device Settings > Network Services > SNMP.
2. Enable or disable "SNMP v1 / v2c" and/or "SNMP v3" by clicking the corresponding checkbox.
 - The SNMP v1/v2c read-only access is enabled by default. The default Read Community String is 'public.'
 - To enable read-write access, type the Write Community String. Usually the string is 'private.'
3. Enter the MIB-II system group information, if applicable.
 - sysContact - the contact person in charge of the system
 - sysName - the name assigned to the system
 - sysLocation - the location of the system
4. To configure SNMP notifications:
 - a. Select the Enable SNMP Notifications checkbox.
 - b. Select a notification type -- SNMPv2c Trap, SNMPv2c Inform, SNMPv3 Trap, and SNMPv3 Inform.
 - c. Specify the SNMP notification destinations and enter necessary information. For details, refer to:
 - *SNMPv2c Notifications* (on page 358)
 - *SNMPv3 Notifications* (on page 359)

*Note: Any changes made to the 'SNMP Notifications' section on the SNMP page will update the settings of the System SNMP Notification Action, and vice versa. See **Available Actions** (on page 289). To add more than three SNMP destinations, you can create new SNMP notification actions. See **Send an SNMP Notification** (on page 300).*

5. You must download the SNMP MIB for your PX3 to use with your SNMP manager.

- a. Click the Download MIBs title bar to show the download links.



- b. Click the PDU2-MIB download link. See *Downloading SNMP MIB* (on page 360).
6. Click Save.

Configuring SMTP Settings

The PX3 can be configured to send alerts or event messages to a specific administrator by email. See *Event Rules and Actions* (on page 272).

To send emails, you have to configure the SMTP settings and enter an IP address for your SMTP server and a sender's email address.

If any email messages fail to be sent successfully, the failure event and reason are available in the event log. See *Viewing or Clearing the Local Event Log* (on page 339).

► **To set SMTP server settings:**

1. Choose Device Settings > Network Services > SMTP Server.
2. Enter the information needed.

Field	Description
Server Name	Type the name or IP address of the mail server.
Port	Type the port number. <ul style="list-style-type: none"> ▪ Default is 25
Sender Email Address	Type an email address for the sender.
Number of Sending Retries	Type the number of email retries. <ul style="list-style-type: none"> ▪ Default is 2 retries
Time Between Sending Retries	Type the interval between email retries in minutes. <ul style="list-style-type: none"> ▪ Default is 2 minutes.
Server Requires Authentication	Select this checkbox if your SMTP server requires password authentication.

Field	Description
User Name, Password	Type a user name and password for authentication after selecting the above checkbox. <ul style="list-style-type: none"> The length of user name and password ranges between 4 and 64. Case sensitive. Spaces are not allowed for the user name, but allowed for the password.
Enable SMTP over TLS (StartTLS)	If your SMTP server supports the Transport Layer Security (TLS), select this checkbox.

- Settings for the CA Certificate:**

Field/setting	Description
	Click this button to install a certificate file. Then you can: <ul style="list-style-type: none"> Click Show to view the certificate's content. Click Remove to delete the installed certificate if it is inappropriate.
Allow expired and not yet valid certificates	<ul style="list-style-type: none"> Select this checkbox to make the authentication succeed regardless of the certificate's validity period. After deselecting this checkbox, the authentication fails whenever any certificate in the selected certificate chain is outdated or not valid yet.

- Now that you have set the SMTP settings, you can test it to ensure it works properly.
 - Type the recipient's email address in the Recipient Email Addresses field. Use a comma to separate multiple email addresses.
 - Click Send Test Email.
 - Check if the recipient(s) receives the email successfully.
- Click Save.

► **Special note for AES ciphers:**

The PX3 device's SSL/TLS-based protocols, including SMTP over StartTLS, support AES 128- and 256-bit ciphers. The exact cipher to use is negotiated between the PX3 and the client (such as a web browser), which is impacted by the cipher priority of the PX3 and the client's cipher availability/settings.

Tip: If intending to force the PX3 to use a specific AES cipher, refer to your client's user documentation for information on configuring AES settings.

Changing SSH Settings

You can enable or disable the SSH access to the command line interface, change the TCP port, or set a password or public key for login over the SSH connection.

► **To change SSH settings:**

1. Choose Device Settings > Network Services > SSH.
2. To enable or disable the SSH access, select or deselect the checkbox.
3. To use a different port, type a port number.
4. Select one of the authentication methods.
 - Password authentication only: Enables the password-based login only.
 - Public key authentication only: Enables the public key-based login only.
 - Password and public key authentication: Enables both the password- and public key-based login. This is the default.
5. Click Save.

If the public key authentication is selected, you must enter a valid SSH public key for each user profile to log in over the SSH connection. See ***Creating Users*** (on page 208).

Changing Telnet Settings

You can enable or disable the Telnet access to the command line interface, or change the TCP port.

► **To change Telnet settings:**

1. Choose Device Settings > Network Services > Telnet.
2. To enable the Telnet access, select the checkbox.

3. To use a different port, type a new port number.
4. Click Save.

Changing Modbus Settings

You can enable or disable the Modbus/TCP access to the PX3, set it to the read-only mode, or change the TCP port.

► **To change the Modbus/TCP settings:**

1. Choose Device Settings > Network Services > Modbus.
2. To enable the Modbus/TCP access, select the "Modbus/TCP Access" checkbox.
3. To use a different port, type a new port number.
4. To enable the Modbus read-only mode, select the checkbox of the "Read-only mode" field. To enable the read-write mode, deselect it.

Enabling Service Advertising

The PX3 advertises all enabled services that are reachable using the IP network. This feature uses DNS-SD (Domain Name System-Service Discovery) and MDNS (Multicast DNS). The advertised services are discovered by clients that have implemented DNS-SD and MDNS.

The advertised services include the following:

- HTTP
- HTTPS
- Telnet
- SSH
- Modbus
- json-rpc
- SNMP

By default, this feature is enabled.

Enabling this feature also enables Link-Local Multicast Name Resolution (LLMNR) and/or MDNS, which are required for resolving APIPA host names. See ***APIPA and Link-Local Addressing*** (on page 3).

The service advertisement feature supports both IPv4 and IPv6 protocols.

If you have set a preferred host name for IPv4 and/or IPv6, that host name can be used as the zero configuration .local host name, that is, *<preferred_host_name>.local*, where *<preferred_host_name>* is the preferred host name you have specified for PX3. The IPv4 host name is the first priority. If an IPv4 host name is not available, then use the IPv6 host name.

*Note: For information on configuring IPv4 and/or IPv6 network settings, see **Wired Network Settings** (on page 219).*

► **To enable or disable service advertising:**

1. Choose Device Settings > Network Services > Service Advertising.
2. To enable the service advertising, select either or both checkboxes.
 - To advertise via MDNS, select the Multicast DNS checkbox.
 - To advertise via LLMNR, select the Link-Local Multicast Name Resolution checkbox.
3. Click Save.

Configuring Security Settings

The PX3 provides tools to control access. You can enable the internal firewall, create firewall rules, and set login limitations. In addition, you can create and install the certificate or set up external authentication servers for access control. This product supports the SHA-2 certificate.

*Tip: To force all HTTP accesses to the PX3 to be redirected to HTTPS, see **Changing HTTP(S) Settings** (on page 240).*

Submenu command	Refer to
IP Access Control	<i>Creating IP Access Control Rules</i> (on page 247)
Role Access Control	<i>Creating Role Access Control Rules</i> (on page 250)
SSL Certificate	<i>Setting Up an SSL/TLS Certificate</i> (on page 252)
Authentication	<i>Setting Up External Authentication</i> (on page 257)
Login Settings	<i>Configuring Login Settings</i> (on page 266)
Password Policy	<i>Configuring Password Policy</i> (on page 267)
Service Agreement	<i>Enabling the Restricted Service Agreement</i> (on page 268)

Creating IP Access Control Rules

IP access control rules (firewall rules) determine whether to accept or discard traffic to/from the PX3, based on the IP address of the host sending or receiving the traffic. When creating rules, keep these principles in mind:

- **Rule order is important.**
When traffic reaches or is sent from the PX3 device, the rules are executed in numerical order. Only the first rule that matches the IP address determines whether the traffic is accepted or discarded. Any subsequent rules matching the IP address are ignored.
- **Subnet mask is required.**
When typing the IP address, you must specify BOTH the address and a subnet mask. For example, to specify a single address in a Class C network, use this format:
x.x.x.x/24
where /24 = a subnet mask of 255.255.255.0.
To specify an entire subnet or range of addresses, change the subnet mask accordingly.

Note: Valid IPv4 addresses range from 0.0.0.0 through 255.255.255.255.

► **To configure IPv4 access control rules:**

1. Choose Device Settings > Security > IP Access Control.
2. Select the Enable IPv4 Access Control checkbox to enable IPv4 access control rules.
3. Determine the IPv4 default policy.
 - Accept: Accepts traffic from all IPv4 addresses.
 - Drop: Discards traffic from all IPv4 addresses, without sending any failure notification to the source host.
 - Reject: Discards traffic from all IPv4 addresses, and an ICMP message is sent to the source host for failure notification.
4. Go to the Inbound Rules section or the Outbound Rules section according to your needs.
 - Inbound rules control the data sent to the PX3.
 - Outbound rules control the data sent from the PX3.
5. Create rules. See the tables for different operations.

ADD a rule to the end of the list



- Click Append.
- Type an IP address and subnet mask in the IP/Mask field.
- Select an option in the Policy field.
 - Accept: Accepts traffic from/to the specified IP address(es).
 - Drop: Discards traffic from/to the specified IP address(es), without sending any failure notification to the source or destination host.
 - Reject: Discards traffic from/to the specified IP address(es), and an ICMP message is sent to the source or destination host for failure notification.

INSERT a rule between two rules

- Select the rule above which you want to insert a new rule. For example, to insert a rule between rules #3 and #4, select #4.
- Click Insert Above.
- Type an IP address and subnet mask in the IP/Mask field.
- Select Accept, Drop or Reject in the Policy field. See the above for their descriptions.

The system automatically numbers the rule.



6. When finished, the rules are listed.

- You can select any existing rule and then click  or  to change its priority.
7. Click Save. The rules are applied.
- ▶ **To configure IPv6 access control rules:**
1. On the same page, select the Enable IPv6 Access Control checkbox to enable IPv6 access control rules.
 2. Follow the same procedure as the above IPv4 rule setup to create IPv6 rules.
 3. **Make sure you click the Save button in the IPv6 section**, or the changes made to IPv6 rules are not saved.

Editing or Deleting IP Access Control Rules

When an existing IP access control rule requires updates of IP address range and/or policy, modify them accordingly. Or you can delete any unnecessary rules.

▶ **To modify or delete a rule:**

1. Choose Device Settings > Security > IP Access Control.
2. Go to the IPv4 or IPv6 section.
3. Select the desired rule in the list.
 - Ensure the IPv4 or IPv6 checkbox has been selected, or you cannot edit or delete any rule.
4. Perform the desired action.
 - Make changes to the selected rule, and then click Save. For information on each field, see *Creating IP Access Control Rules* (on page 247).
 - Click  to remove it.
 - To resort its order, click  or .
5. Click Save.
 - IPv4 rules: **Make sure you click the Save button in the IPv4 section**, or the changes made to IPv4 rules are not saved.
 - IPv6 rules: **Make sure you click the Save button in the IPv6 section**, or the changes made to IPv6 rules are not saved.

Creating Role Access Control Rules

Role-based access control rules are similar to IP access control rules, except they are applied to members of a specific role. This enables you to grant system permissions to a specific role, based on their IP addresses.

Same as IP access control rules, the order of role-based access control rules is important, since the rules are executed in numerical order.

► **To create IPv4 role-based access control rules:**

1. Choose Device Settings > Security > Role Access Control.
2. Select the "Enable Role Based Access Control for IPv4" checkbox to enable IPv4 access control rules.
3. Determine the IPv4 default policy.
 - Allow: Accepts traffic from all IPv4 addresses regardless of the user's role.
 - Deny: Drops traffic from all IPv4 addresses regardless of the user's role.
4. Create rules. See the tables for different operations.

ADD a rule to the end of the list

- Click Append.
- Type a starting IP address in the Start IP field.
- Type an ending IP address in the End IP field.
- Select a role in the Role field. This rule applies to members of this role only.
- Select an option in the Policy field.
 - Allow: Accepts traffic from the specified IP address range when the user is a member of the specified role
 - Deny: Drops traffic from the specified IP address range when the user is a member of the specified role

INSERT a rule between two rules

- Select the rule above which you want to insert a new rule. For example, to insert a rule between rules #3 and #4, select #4.
- Click Insert Above.
- Type a starting IP address in the Start IP field.
- Type an ending IP address in the End IP field.
- Select a role in the Role field. This rule applies to members of this role only.
- Select Allow or Deny in the Policy field. See the above for their descriptions.

The system automatically numbers the rule.

5. When finished, the rules are listed on this page.

- You can select any existing rule and then click  or



to change its priority.

6. Click Save. The rules are applied.

► **To configure IPv6 access control rules:**



1. On the same page, select the "Enable Role Based Access Control for IPv6" checkbox to enable IPv6 access control rules.
2. Follow the same procedure as the above IPv4 rule setup to create IPv6 rules.
3. **Make sure you click the Save button in the IPv6 section**, or the changes made to IPv6 rules are not saved.

Editing or Deleting Role Access Control Rules

You can modify existing rules to update their roles/IP addresses, or or delete them when they are no longer needed.

► **To modify a role-based access control rule:**

1. Choose Device Settings > Security > Role Access Control.
2. Go to the IPv4 or IPv6 section.
3. Select the desired rule in the list.
 - Ensure the IPv4 or IPv6 checkbox has been selected, or you cannot select any rule.
4. Perform the desired action.
 - Make changes to the selected rule, and then click Save. For information on each field, see *Creating Role Access Control Rules* (on page 250).

- Click  to remove it.
 - To resort its order, click  or .
5. Click Save.
- IPv4 rules: **Make sure you click the Save button in the IPv4 section**, or the changes made to IPv4 rules are not saved.
 - IPv6 rules: **Make sure you click the Save button in the IPv6 section**, or the changes made to IPv6 rules are not saved.

Setting Up an SSL/TLS Certificate

Important: Raritan uses TLS instead of SSL 3.0 due to published security vulnerabilities in SSL 3.0. Make sure your network infrastructure, such as LDAP and mail services, uses TLS rather than SSL 3.0.

Having an X.509 digital certificate ensures that both parties in an SSL/TLS connection are who they say they are.

▶ **To obtain a CA-signed certificate:**

1. Create a Certificate Signing Request (CSR) on the PX3. See *Creating a CSR* (on page 253).
2. Submit it to a certificate authority (CA). After the CA processes the information in the CSR, it provides you with a certificate.
3. Install the CA-signed certificate onto the PX3. See *Installing a CA-Signed Certificate* (on page 254).

Note: If you are using a certificate that is part of a chain of certificates, each part of the chain is signed during the validation process.

▶ **A CSR is not required in either scenario below:**

- Make the PX3 create a *self-signed* certificate. See *Creating a Self-Signed Certificate* (on page 255).
- Appropriate, valid certificate and key files are already available, and you just need to install them. See *Installing or Downloading Existing Certificate and Key* (on page 256).

Creating a CSR

Follow this procedure to create the CSR for your PX3 device.

Note that you must enter information in the fields showing the message 'required.'

required

► **To create a CSR:**

1. Choose Device Settings > Security > SSL Certificate.
2. Provide the information requested.
 - **Subject:**

Field	Description
Country	The country where your company is located. Use the standard ISO country code. For a list of ISO codes, visit the <i>ISO website</i> (http://www.iso.org/iso/country_codes/iso_3166_code_lists.htm).
State or Province	The full name of the state or province where your company is located.
Locality	The city where your company is located.
Organization	The registered name of your company.
Organizational Unit	The name of your department.
Common Name	The fully qualified domain name (FQDN) of your PX3 device.
Email Address	An email address where you or another administrative user can be reached.

Warning: If you generate a CSR without values entered in the required fields, you cannot obtain third-party certificates.

▪ **Key Creation Parameters:**

Field	Do this
Key Length	Select an available key length (bits). A larger key length enhances the security, but slows down the PX3 device's response. <ul style="list-style-type: none"> ▪ Only 2048 is available now.
Self Sign	For requesting a certificate signed by the CA, ensure this checkbox is NOT selected.

Field	Do this
Challenge, Confirm Challenge	Type a password. The password is used to protect the certificate or CSR. This information is optional. The value should be 4 to 64 characters long. Case sensitive.

3. Click Create New SSL Key to create both the CSR and private key. This may take several minutes to complete.
4. Click Download Certificate Signing Request to download the CSR to your computer.
 - a. You are prompted to open or save the file. Click Save to save it onto your computer.
 - b. Submit it to a CA to obtain the digital certificate.
 - c. If the CSR contains incorrect data, click Delete Certificate Signing Request to remove it, and then repeat the above steps to re-create it.
5. To store the newly-created private key on your computer, click Download Key in the **New SSL Certificate** section.

Note: The Download Key button in the Active SSL Certificate section is for downloading the private key of the currently-installed certificate rather than the newly-created one.

- You are prompted to open or save the file. Click Save to save it onto your computer.
6. After getting the CA-signed certificate, install it. See **Installing a CA-Signed Certificate** (on page 254).

Installing a CA-Signed Certificate

To get a certificate from a certificate authority (CA), first create a CSR and send it to the CA. See **Creating a CSR** (on page 253).

After receiving the CA-signed certificate, install it onto the PX3.

► **To install the CA-signed certificate:**

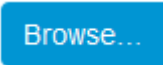
1. Choose Device Settings > Security > SSL Certificate.
2. Click  to navigate to the CA-signed certificate file.
3. Click Upload to install it.
4. To verify whether the certificate has been installed successfully, check the data shown in the Active SSL Certificate section.

Creating a Self-Signed Certificate

When appropriate certificate and key files for the PX3 device are unavailable, the alternative, other than submitting a CSR to the CA, is to generate a self-signed certificate.

Note that you must enter information in the fields showing the message 'required.'

required

► **To create and install a self-signed certificate:**

1. Choose Device Settings > Security > SSL Certificate.
2. Enter information.

Field	Description
Country	The country where your company is located. Use the standard ISO country code. For a list of ISO codes, visit the <i>ISO website</i> (http://www.iso.org/iso/country_codes/iso_3166_code_lists.htm).
State or Province	The full name of the state or province where your company is located.
Locality	The city where your company is located.
Organization	The registered name of your company.
Organizational Unit	The name of your department.
Common Name	The fully qualified domain name (FQDN) of your PX3 device.
Email Address	An email address where you or another administrative user can be reached.
Key Length	Select an available key length (bits). A larger key length enhances the security, but slows down the PX3 device's response. <ul style="list-style-type: none"> ▪ Only 2048 is available now.
Self Sign	Ensure this checkbox is selected, which indicates that you are creating a self-signed certificate.
Validity in days	This field appears after the Self Sign checkbox is selected. Type the number of days for which the self-signed certificate will be valid.

A password is not required for a self-signed certificate so the Challenge and Confirm Challenge fields disappear.

3. Click Create New SSL Key to create both the self-signed certificate and private key. This may take several minutes to complete.

4. Once complete, do the following:
 - a. Double check the data shown in the New SSL Certificate section.
 - b. If correct, click "Install Key and Certificate" to install the self-signed certificate and private key.

Tip: To verify whether the certificate has been installed successfully, check the data shown in the Active SSL Certificate section.

If incorrect, click "Delete Key and Certificate" to remove the self-signed certificate and private key, and then repeat the above steps to re-create them.

5. (Optional) To download the self-signed certificate and/or private key, click Download Certificate or Download Key in the New SSL Certificate section.
 - You are prompted to open or save the file. Click Save to save it onto your computer.

Note: The Download Key button in the Active SSL Certificate section is for downloading the private key of the currently-installed certificate rather than the newly-created one.

Installing or Downloading Existing Certificate and Key

You can download the already-installed certificate and private key from any PX3 for backup or file transfer. For example, you can install the files onto a replacement PX3 device, add the certificate to your browser and so on.

If valid certificate and private key files are already available, you can install them on the PX3 without going through the process of creating a CSR or a self-signed certificate.

Note: If you are using a certificate that is part of a chain of certificates, each part of the chain is signed during the validation process.

► To download active key and certificate files from the PX3:

1. Choose Device Settings > Security > SSL Certificate.
2. In the *Active SSL Certificate* section, click Download Key and Download Certificate respectively.

Note: The Download Key button in the New SSL Certificate section, if present, is for downloading the newly-created private key rather than the one of the currently-installed certificate.

3. You are prompted to open or save the file. Click Save to save it onto your computer.

► **To install available key and certificate files onto the PX3:**

1. Choose Device Settings > Security > SSL Certificate.
2. Select the "Upload Key and Certificate" checkbox at the bottom of the page.

3. The Key File and Certificate File fields appear. Click  to select the key and/or certificate file.
4. Click Upload. The selected files are installed.
5. To verify whether the certificate has been installed successfully, check the data shown in the Active SSL Certificate section.

Setting Up External Authentication

Important: Raritan uses TLS instead of SSL 3.0 due to published security vulnerabilities in SSL 3.0. Make sure your network infrastructure, such as LDAP and mail services, uses TLS rather than SSL 3.0.

For security purposes, users attempting to log in to the PX3 must be authenticated. The PX3 supports the following authentication mechanisms:

- Local user database on the PX3
- Lightweight Directory Access Protocol (LDAP)
- Remote Access Dial-In User Service (Radius) protocol

By default, the PX3 is configured for local authentication. If you stay with this method, you only need to create user accounts. See *Creating Users* (on page 208).

If you prefer external authentication, you must provide the PX3 with information about the external Authentication and Authorization (AA) server.

If both local and external authentication is needed, create user accounts on the PX3 in addition to providing the external AA server data.

When configured for external authentication, all PX3 users must have an account on the external AA server. Local-authentication-only users will have no access to the PX3 except for the admin, who always can access the PX3.

If the external authentication fails, an "Authentication failed" message is displayed. Details regarding the authentication failure are available in the event log. See *Viewing or Clearing the Local Event Log* (on page 339).

Note that only users who have both the "Change Authentication Settings" and "Change Security Settings" permissions can configure or modify the authentication settings.

► **To enable external authentication:**

1. Collect external AA server information. See *Gathering LDAP/Radius Information* (on page 259).
2. Enter required data for external AA server(s) on the PX3. See *Adding LDAP/LDAPS Servers* (on page 260) or *Adding Radius Servers* (on page 263).
 - For illustrations, see *LDAP Configuration Illustration* (on page 621) or *Radius Configuration Illustration* (on page 634).
3. If both the external and local authentication is needed, or you have to return to the local authentication only, see *Managing External Authentication Settings* (on page 265).

► **Special note about the AES cipher:**

The PX3 device's SSL/TLS-based protocols, including LDAPS, support AES 128- and 256-bit ciphers. The exact cipher to use is negotiated between the PX3 and the client (such as a web browser), which is impacted by the cipher priority of the PX3 and the client's cipher availability/settings.

Tip: If intending to force the PX3 to use a specific AES cipher, refer to your client's user documentation for information on configuring AES settings.

Gathering LDAP/Radius Information

It requires knowledge of your AA server settings to configure the PX3 for external authentication. If you are not familiar with these settings, consult your AA server administrator for help.

► **Information needed for LDAP authentication:**

- The IP address or hostname of the LDAP server
- Whether the Secure LDAP protocol (LDAP over TLS) is being used
 - If Secure LDAP is in use, consult your LDAP administrator for the CA certificate file.
- The network port used by the LDAP server
- The type of the LDAP server, usually one of the following options:
 - *OpenLDAP*
 - If using an OpenLDAP server, consult the LDAP administrator for the Bind Distinguished Name (DN) and password.
 - *Microsoft Active Directory® (AD)*

- If using a Microsoft Active Directory server, consult your AD administrator for the name of the Active Directory Domain.
 - Bind Distinguished Name (DN) and password (if anonymous bind is NOT used)
 - The Base DN of the server (used for searching for users)
 - The login name attribute (or AuthorizationString)
 - The user entry object class
 - The user search subfilter (or BaseSearch)
- ▶ **Information needed for Radius authentication:**
- The IP address or host name of the Radius server
 - Authentication protocol used by the Radius server
 - Shared secret for a secure communication
 - UDP authentication port and accounting port used by the Radius server

Adding LDAP/LDAPS Servers

To use LDAP authentication, enable it and enter the information you have gathered.

Note that you must enter information in the fields showing the message 'required.'



- ▶ **To add LDAP/LDAPS servers:**
1. Choose Device Settings > Security > Authentication.
 2. Click New in the LDAP Servers section.
 3. Enter information.

Field/setting	Description
IP Address / Hostname	The IP address or hostname of your LDAP/LDAPS server. <ul style="list-style-type: none"> ▪ Important: Without the encryption enabled, you can type either the domain name or IP address in this field, but you must type the fully qualified domain name if the encryption is enabled.
Copy settings from existing LDAP server	This checkbox appears only when there are existing AA server settings on the PX3. To duplicate any existing AA server's settings, refer to the duplicating procedure below.

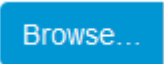
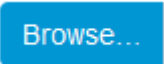
Field/setting	Description
Type of LDAP Server	Choose one of the following options: <ul style="list-style-type: none"> OpenLDAP Microsoft Active Directory. Active Directory is an implementation of LDAP/LDAPS directory services by Microsoft for use in Windows environments.
Security	Determine whether you would like to use Transport Layer Security (TLS) encryption, which allows the PX3 to communicate securely with the LDAPS server. Three options are available: <ul style="list-style-type: none"> StartTLS TLS None
Port (None/StartTLS)	The default Port is 389. Either use the standard LDAP TCP port or specify another port.
Port (TLS)	Configurable only when "TLS" is selected in the Security field. The default is 636. Either use the default port or specify another one.
Enable verification of LDAP Server Certificate	Select this checkbox if it is required to validate the LDAP server's certificate by the PX3 prior to the connection. If the certificate validation fails, the connection is refused.
CA Certificate	Consult your AA server administrator to get the CA certificate file for the LDAPS server.  Click  to select and install the certificate file. <ul style="list-style-type: none"> Click Show to view the installed certificate's content. Click Remove to delete the installed certificate if it is inappropriate.
Allow expired and not yet valid certificates	<ul style="list-style-type: none"> Select this checkbox to make the authentication succeed regardless of the certificate's validity period. After deselecting this checkbox, the authentication fails whenever any certificate in the selected certificate chain is outdated or not valid yet.
Anonymous Bind	Use this checkbox to enable or disable anonymous bind. <ul style="list-style-type: none"> To use anonymous bind, select this checkbox. When a Bind DN and password are required to bind to the external LDAP/LDAPS server, deselect this checkbox.

Field/setting	Description
Bind DN	Required after deselecting the Anonymous Bind checkbox. Distinguished Name (DN) of the user who is permitted to search the LDAP directory in the defined search base.
Bind Password, Confirm Bind Password	Required after deselecting the Anonymous Bind checkbox. Enter the Bind password.
Base DN for Search	Distinguished Name (DN) of the search base, which is the starting point of the LDAP search. <ul style="list-style-type: none"> Example: <code>ou=dev,dc=example,dc=com</code>
Login Name Attribute	The attribute of the LDAP user class which denotes the login name. <ul style="list-style-type: none"> Usually it is the <code>uid</code>.
User Entry Object Class	The object class for user entries. <ul style="list-style-type: none"> Usually it is <code>inetOrgPerson</code>.
User Search Subfilter	Search criteria for finding LDAP user objects within the directory tree.
Active Directory Domain	The name of the Active Directory Domain. <ul style="list-style-type: none"> Example: <code>testradius.com</code>

- To verify if the authentication configuration is set correctly, click Test Connection to check whether the PX3 can connect to the new server successfully.

*Tip: You can also test the connection on the Authentication page after finishing adding servers. See **Managing External Authentication Settings** (on page 265).*

- Click Add Server. The new LDAP server is listed on the Authentication page.
- To add more servers, repeat the same steps.
- In the Authentication Type field, select LDAP.** Otherwise, the LDAP authentication does not work.
- Click Save. The LDAP authentication is now in place.

► **To duplicate LDAP/LDAPS server settings:**

If you have added any LDAP/LDAPS server to the PX3, and the server you will add shares identical settings with an existing one, the most convenient way is to duplicate that LDAP/LDAPS server's data and then revise the IP address/host name.

1. Repeat Steps 1 to 2 in the above procedure.
2. Select the "Copy settings from existing LDAP server" checkbox.
3. Click the "Select LDAP Server" field to select the LDAP/LDAPS server whose settings you want to copy.
4. Modify the IP Address/Hostname field.
5. Click Add Server.

Note: If the PX3 clock and the LDAP server clock are out of sync, the installed TLS certificates, if any, may be considered expired. To ensure proper synchronization, administrators should configure the PX3 and the LDAP server to use the same NTP server(s).

Adding Radius Servers

To use Radius authentication, enable it and enter the information you have gathered.

Note that you must enter information in the fields showing the message 'required.'

required

► **To add Radius servers:**

1. Choose Device Settings > Security > Authentication.
2. Click New in the Radius section.
3. Enter information.

Field/setting	Description
IP Address / Hostname	The IP address or hostname of your Radius server.
Type of RADIUS Authentication	<p>Select an authentication protocol.</p> <ul style="list-style-type: none"> ▪ PAP (Password Authentication Protocol) ▪ CHAP (Challenge Handshake Authentication Protocol) <p>CHAP is generally considered more secure because the user name and password are encrypted, while in PAP they are transmitted in the clear.</p>

Field/setting	Description
Authentication Port, Accounting Port	The default are standard ports -- 1812 and 1813. To use non-standard ports, type a new port number.
Timeout	This sets the maximum amount of time to establish contact with the Radius server before timing out. Type the timeout period in seconds.
Retries	Type the number of retries.
Shared Secret, Confirm Shared Secret	The shared secret is necessary to protect communication with the Radius server.

- To verify if the authentication configuration is set correctly, click Test Connection to check whether the PX3 can connect to the new server successfully.

*Tip: You can also test the connection on the Authentication page after finishing adding servers. See **Managing External Authentication Settings** (on page 265).*

- Click Add Server. The new Radius server is listed on the Authentication page.
- To add more servers, repeat the same steps.
- In the Authentication Type field, select Radius.** Otherwise, the Radius authentication does not work.
- Click Save. Radius authentication is now in place.

Managing External Authentication Settings



Choose Device Settings > Security > Authentication to open the Authentication page, where you can:

- Enable both the external and local authentication
- Edit or delete a server
- Resort the access order of servers
- Test the connection to a server
- Disable external authentication without removing servers

► **To test, edit or delete a server, or resort the server list:**

1. Select a server in the list.

Access Order	IP Address / Hostname	Security	Port	LDAP Server Type
1	192.168.91.100	None	389	OpenLDAP
2	192.168.1.33	StartTLS	389	OpenLDAP
3	192.168.8.95	None	389	Microsoft Active Directory

2. Perform the desired action.
 - Click Edit to edit its settings, and click Modify Server to save changes. For information on each field, see **Adding LDAP/LDAPS Servers** (on page 260) or **Adding Radius Servers** (on page 263).
 - Click Delete to delete the server, and then confirm the operation.
 - Click Test Connection to test the connection to the selected server. User credentials may be required.
 - Click  or  to change the server order, which determines the access priority, and click Save Order to save the new sequence.

Note: Whenever the PX3 is successfully connected to one external authentication server, it STOPS trying to access the remaining servers in the authentication list regardless of the user authentication result.

► **To enable both the external and local authentication:**

1. In the Authentication Type field, select the external authentication you want -- LDAP or Radius.

2. Select the following checkbox. Then the PX3 always tries external authentication first. Whenever the external authentication fails, the PX3 switches to local authentication.

Use Local Authentication if Remote Authentication is not available

3. Click Save.

► **To disable external authentication:**

1. In the Authentication Type, select Local.
2. Click Save.

Configuring Login Settings

Choose Device Settings > Security > Login Settings to open the Login Settings page, where you can:

- Configure the user blocking feature.

Note: The user blocking function applies only to local authentication instead of external authentication through AA servers.

- Determine the timeout period for any inactive user.
- Prevent simultaneous logins using the same login name.

► **To configure user blocking:**

1. To enable the user blocking feature, select the "Block user on login failure" checkbox.
2. In the "Maximum number of failed logins" field, type a number. This is the maximum number of login failure the user is permitted before the user is blocked from accessing the PX3.
3. In the "Block timeout" field, type a value or click  to select a time option. This setting determines how long the user is blocked.
 - If you type a value, the value must be followed by a time unit, such as '4 min.' See **Time Units** (on page 153).
4. Click Save.

*Tip: If any user blocking event occurs, you can unblock that user manually by using the "unblock" CLI command over a local connection. See **Unblocking a User** (on page 528).*

► **To set limitations for login timeout and use of identical login names:**

1. In the "Idle timeout period" field, type a value or click  to select a time option. This setting determines how long users are permitted to stay idle before being forced to log out.
 - If you type a value, the value must be followed by a time unit, such as '4 min.' See **Time Units** (on page 153).
 - Keep the idle timeout to 20 minutes or less if possible. This reduces the number of idle sessions connected, and the number of simultaneous commands sent to the PX3.
2. Select the "Prevent concurrent login with same username" checkbox if intending to prevent multiple persons from using the same login name simultaneously.
3. Click Save.

Configuring Password Policy

Choose Device Settings > Security > Password Policy to open the Password Policy page, where you can:

- Force users to use strong passwords.
- Force users to change passwords at a regular interval -- that is, password aging.

Use of strong passwords makes it more difficult for intruders to crack user passwords and access the PX3 device.

► **To configure password aging:**

1. Select the 'Enabled' checkbox of Password Aging.
2. In the Password Aging Interval field, type a value or click  to select a time option. This setting determines how often users are requested to change their passwords.
 - If you type a value, the value must be followed by a time unit, such as '10 d.' See **Time Units** (on page 153).
3. Click Save.

► **To force users to create strong passwords:**

1. Select the 'Enabled' checkbox of Strong Passwords to activate the strong password feature. The following are the default settings:

Minimum length	= 8 characters
Maximum length	= 32 characters
At least one lowercase character	= Required
At least one uppercase character	= Required
At least one numeric character	= Required
At least one special character	= Required
Number of forbidden previous passwords	= 5

Note: The maximum password length accepted by the PX3 is 64 characters.

2. Make changes to the default settings as needed.
3. Click Save.

Enabling the Restricted Service Agreement

The restricted service agreement feature, if enabled, forces users to read a security agreement when they log in to the PX3.

Users must accept the agreement, or they cannot log in.

An event notifying you if a user has accepted or declined the agreement can be generated. See *Default Log Messages* (on page 278)

► **To enable the service agreement:**

1. Click Device Settings > Security > Service Agreement.
2. Select the Enforce Restricted Service Agreement checkbox.
3. Edit or paste the content as needed.
 - A maximum of 10,000 characters can be entered.
4. Click Save.

► **Login manner after enabling the service agreement:**

After the Restricted Service Agreement feature is enabled, the agreement's content is displayed in the login screen.

Do either of the following, or the login fails:

- In the web interface, select the checkbox labeled "I understand and accept the Restricted Service Agreement."

Tip: To select the agreement checkbox using the keyboard, first press Tab to go to the checkbox and then Enter.

- In the CLI, type `y` when the confirmation message "I understand and accept the Restricted Service Agreement" is displayed.

Setting the Date and Time



Set the internal clock on the PX3 device manually, or link to a Network Time Protocol (NTP) server.

Note: If you are using Sunbird's Power IQ to manage the PX3, you must configure Power IQ and the PX3 to have the same date/time or NTP settings.

► **To set the date and time:**

1. Choose Device Settings > Date/Time.
2. Click the Time Zone field to select your time zone from the list.
3. If the daylight saving time applies to your time zone, verify the Automatic Daylight Saving Time Adjustment checkbox is selected.
 - If the daylight saving time rules are not available for the selected time zone, the checkbox is not configurable.
4. Select the method for setting the date and time.

Customize the date and time

- Select User Specified Time.
- Type values in the Date field using the yyyy-mm-dd format, or click  to select a date. For details, see *Calendar* (on page 270).
- Type values in the Time field using the hh:mm:ss format, or click   to adjust values.
 - The time is measured in 12-hour format so you must correctly specify AM or PM by clicking the AM or PM button.

12 : 00 : 00 AM

Use the NTP server

- Select "Synchronize with NTP Server."
- There are two ways to assign the NTP servers:
 - To use the DHCP-assigned NTP servers, DO NOT enter any NTP servers for the First and Second NTP Server.
DHCP-assigned NTP servers are available only when either IPv4 or IPv6 DHCP is enabled.
 - To use the manually-specified NTP servers, specify the primary NTP server in the First Time Server field. A secondary NTP server is optional.
Click Check NTP Servers to verify the validity and accessibility of the manually-specified NTP servers.

5. Click Save.

The PX3 follows the NTP server sanity check per the IETF RFC. If your PX3 has problems synchronizing with a Windows NTP server, see *Windows NTP Server Synchronization Solution* (on page 271).

Calendar



The calendar icon  in the Date field is a convenient tool to select a custom date. Click it and a calendar appears.

Button	Function
arrows	Switch between months.

Button	Function
dates (01-31)	Click a date.
Today	Select today.
Clear	Clear the entry, if any, in the Date field.
Close	Close the calendar.

Windows NTP Server Synchronization Solution

The NTP client on the PX3 follows the NTP RFC so the PX3 rejects any NTP servers whose root dispersion is more than one second. An NTP server with a dispersion of more than one second is considered an inaccurate NTP server by the PX3.

Note: For information on NTP RFC, visit

<http://tools.ietf.org/html/rfc4330> <http://tools.ietf.org/html/rfc4330> to refer to section 5.

Windows NTP servers may have a root dispersion of more than one second, and therefore cannot synchronize with the PX3. When the NTP synchronization issue occurs, change the dispersion settings to resolve it.

► To change the Windows NTP's root dispersion settings:

1. Access the registry settings associated with the root dispersion on the Windows NTP server.

HKEY_LOCAL_MACHINE\SYSTEM\CurrentControlSet\Services\W32Time\Config

2. *AnnounceFlags* must be set to 0x05 or 0x06.
 - 0x05 = 0x01 (Always time server) and 0x04 (Always reliable time server)
 - 0x06 = 0x02 (Automatic time server) and 0x04 (Always reliable time server)

Note: Do NOT use 0x08 (Automatic reliable time server) because its dispersion starts at a high value and then gradually decreases to one second or lower.

3. *LocalClockDispersion* must be set to 0.

Event Rules and Actions

A benefit of the product's intelligence is its ability to notify you of or react to a change in conditions. This event notification or reaction is an "event rule."

An event rule consists of two parts:

- **Event:** This is the situation where the PX3 or a device connected to it meets a certain condition. For example, the inlet's voltage reaches the warning level.
- **Action:** This is the response to the event. For example, the PX3 notifies the system administrator of the event via email.

If you want the PX3 to perform one action at a regular interval instead of waiting until an event occurs, you can schedule that action. For example, you can make the PX3 email the temperature report every hour.

Note that you need the Administrator Privileges to configure event rules.

► To create an event rule:

1. Choose Device Settings > Event Rules.
2. If the needed action is not available yet, create it by clicking **+ New Action**.
 - a. Assign a name to this action.
 - b. Select the desired action and configure it as needed.
 - c. Click Create.

For details, see *Available Actions* (on page 289).

3. Click **+ New Rule** to create a new rule.
 - a. Assign a name to this rule.
 - b. Make sure the Enabled checkbox is selected, or the new event rule does not work.
 - c. In the Event field, select the event to which you want the PX3 to react.
 - d. In the Available Actions field, select the desired action(s) to respond to the selected event.
 - e. Click Create.

For details, see *Built-in Rules and Rule Configuration* (on page 273).

► To create a scheduled action:

1. If the needed action is not available yet, create it by clicking **+ New Action**. See above.

Note: When creating scheduled actions, available actions are less than usual because it is meaningless to schedule certain actions like "Alarm," "Log event message," "Send email," "Syslog message" and the like.

2. Click **+ New Scheduled Action** to schedule the desired action.
 - a. Assign a name to this scheduled action.
 - b. Make sure the Enabled checkbox is selected, or the PX3 does not perform this scheduled action.
 - c. Set the interval time, which ranges from every minute to yearly.
 - d. In the Available Actions field, select the desired action(s).
 - e. Click Create.

For details, see *Scheduling an Action* (on page 306).

Built-in Rules and Rule Configuration

The PX3 is shipped with four built-in event rules, which cannot be deleted. If the built-in event rules do not satisfy your needs, create new rules.

► Built-in rules:

- *System Event Log Rule:*

This causes ANY event occurred to the PX3 to be recorded in the internal log. It is enabled by default.

*Note: For the default log messages generated for each event, see **Default Log Messages** (on page 278).*

- *System SNMP Notification Rule:*

This causes SNMP traps or informs to be sent to specified IP addresses or hosts when ANY event occurs to the PX3. It is disabled by default.

- *System Tamper Detection Alarmed:*

This causes the PX3 to send alarm notifications if a DX tamper sensor has been connected and the PX3 detects that the tamper sensor enters the alarmed state. It is enabled by default.

- *System Tamper Detection Unavailable:*

This causes the PX3 to send alarm notifications if a DX tamper sensor was once connected or remains connected but then the PX3 does not detect the presence of the tamper sensor. It is enabled by default.

► **Event rule configuration illustration:**

1. Choose Device Settings > Event Rules > **+ New Rule**.
2. Click the Event field to select an event type.
 - <Any sub-event> means all events shown on the list.
 - <Any Numeric Sensor> means all numeric sensors of the PX3, including internal and environmental sensors. <Any Numeric Sensor> is especially useful if you want to receive the notifications when any numeric sensor's readings pass through a specific threshold.
3. In this example, the Peripheral Device Slot is selected, which is related to the environmental sensor packages. Then a sensor ID field for this event type appears. Click this additional field to specify which sensor should be the subject of this event.
4. In this example, sensor ID 2 (Slot 2) is selected, which is a temperature sensor. Then a new field for this sensor appears. Click this field to specify the type of event(s) you want.
5. In this example, Numeric Sensor is selected because we want to select numeric-sensor-related event(s). Then a field for numeric-sensor-related events appears. Click this field to select one of the numeric-sensor-related events from the list.

6. In this example, 'Above upper critical threshold' is selected because we want the PX3 to react only when the selected temperature sensor's reading enters the upper critical range. A "Trigger condition" field appears, requiring you to define the "exact" condition related to the "upper critical" event.

The screenshot shows a configuration panel with two main sections: 'Event' and 'Trigger condition'. The 'Event' section consists of four stacked dropdown menus. The first dropdown is set to 'Peripheral Device Slot', the second to 'Slot 2 (Temperature 2)', the third to 'Numeric Sensor', and the fourth to 'Above upper critical threshold'. The 'Trigger condition' section contains three radio buttons: 'Asserted', 'Deasserted', and 'Both'. The 'Both' radio button is selected, and a mouse cursor is pointing at it.

7. Select the desired radio button to finish the event configuration. Refer to the following table for different types of radio buttons.
 - If needed, you may refer to event rule examples in the section titled **Sample Event Rules** (on page 313).
8. To select any action(s), select them one by one from the Available Actions list.
 - To select all available actions, click Select All.
9. To remove any action(s) from the Selected Actions field, click that action's **X**.
 - To remove all actions, click Deselect All.

► **Radio buttons for different events:**

According to the event you select, the "Trigger condition" field containing three radio buttons may or may not appear.

Event types	Radio buttons
Numeric sensor threshold-crossing events, or the occurrence of the selected event -- true or false	Available radio buttons include "Asserted," "Deasserted" and "Both." <ul style="list-style-type: none"> ▪ Asserted: The PX3 takes the action only when the selected event occurs. That is, the status of the event transits from FALSE to TRUE. ▪ Deasserted: The PX3 takes the action only when the selected event disappears or stops. That is, the status of the selected event transits from TRUE to FALSE. ▪ Both: The PX3 takes the action both when the event occurs (asserts) and when the event stops/disappears (deasserts).
State sensor state change	Available radio buttons include "Alarmed/Open/On," "No longer alarmed/Closed/Off" and "Both." <ul style="list-style-type: none"> ▪ Alarmed/Open/On: The PX3 takes the action only when the chosen sensor enters the alarmed, open or on state. ▪ No longer alarmed/Closed/Off: The PX3 takes the action only when the chosen sensor returns to the normal, closed, or off state. ▪ Both: The PX3 takes the action whenever the chosen sensor switches its state.
Sensor availability	Available radio buttons include "Unavailable," "Available" and "Both." <ul style="list-style-type: none"> ▪ Unavailable: The PX3 takes the action only when the chosen sensor is NOT detected and becomes unavailable. ▪ Available: The PX3 takes the action only when the chosen sensor is detected and becomes available. ▪ Both: The PX3 takes the action both when the chosen sensor becomes unavailable or available.

Event types	Radio buttons
Network interface link state	<ul style="list-style-type: none"> ▪ Link state is up: The PX3 takes the action only when the network link state changes from down to up. ▪ Link state is down: The PX3 takes the action only when the network link state changes from up to down. ▪ Both: The PX3 takes the action whenever the network link state changes.
Function enabled or disabled	<ul style="list-style-type: none"> ▪ Enabled: The PX3 takes the action only when the chosen function is enabled. ▪ Disabled: The PX3 takes the action only when the chosen function is disabled. ▪ Both: The PX3 takes the action when the chosen function is either enabled or disabled.
Restricted service agreement	<ul style="list-style-type: none"> ▪ Accepted: The PX3 takes the action only when the specified user accepts the restricted service agreement. ▪ Declined: The PX3 takes the action only when the specified user rejects the restricted service agreement. ▪ Both: The PX3 takes the action both when the specified user accepts or rejects the restricted service agreement.
Server monitoring event	<ul style="list-style-type: none"> ▪ Monitoring started: The PX3 takes the action only when the monitoring of any specified server starts. ▪ Monitoring stopped: The PX3 takes the action only when the monitoring of any specified server stops. ▪ Both: The PX3 takes the action when the monitoring of any specified server starts or stops.

Event types	Radio buttons
Server reachability	<ul style="list-style-type: none"> ▪ Unreachable: The PX3 takes the action only when any specified server becomes inaccessible. ▪ Reachable: The PX3 takes the action only when any specified server becomes accessible. ▪ Both: The PX3 takes the action when any specified server becomes either inaccessible or accessible.
Device connection or disconnection, such as a USB-cascaded slave device	<ul style="list-style-type: none"> ▪ Connected: The PX3 takes the action only when the selected device is physically connected to it. ▪ Disconnected: The PX3 takes the action only when the selected device is physically disconnected from it. ▪ Both: The PX3 takes the action both when the selected device is physically connected to it and when it is disconnected.
+12V Supply 1 Status	<p>Available radio buttons include "Fault," "Ok" and "Both."</p> <ul style="list-style-type: none"> ▪ Fault: The PX3 takes the action only when the selected 12V power supply to the controller enters the fault state. ▪ Ok: The PX3 takes the action only when when the selected 12V power supply to the controller enters the OK state. ▪ Both: The PX3 takes the action whenever the selected 12 power supply's status changes.

Default Log Messages

Following are default log messages recorded internally and emailed to specified recipients when PX3 events occur (are TRUE) or, in some cases, stop or become unavailable (are FALSE). See *Send Email* (on page 296) for information configuring email messages to be sent when specified events occur.

Event/context	Default message when the event = TRUE	Default message when the event = FALSE
Asset Management > State	State of asset strip [STRIPID] ('[STRIPNAME]') changed to '[STATE]'.	
Asset Management > Rack Unit > * > Tag Connected	Asset tag with ID '[TAGID]' connected at rack unit [RACKUNIT], slot [RACKSLOT] of asset strip [STRIPID] ('[STRIPNAME]').	Asset tag with ID '[TAGID]' disconnected at rack unit [RACKUNIT], slot [RACKSLOT] of asset strip [STRIPID] ('[STRIPNAME]').
Asset Management > Rack Unit > * > Blade Extension Connected	Blade extension with ID '[TAGID]' connected at rack unit [RACKUNIT] of asset strip [STRIPID] ('[STRIPNAME]').	Blade extension with ID '[TAGID]' disconnected at rack unit [RACKUNIT] of asset strip [STRIPID] ('[STRIPNAME]').
Asset Management > Firmware Update	Firmware update for asset strip [STRIPID] ('[STRIPNAME]'): status changed to '[STATE]'.	
Asset Management > Device Config Changed	Config parameter '[PARAMETER]' of asset strip [STRIPID] ('[STRIPNAME]') changed to '[VALUE]' by user '[USERNAME]'.	
Asset Management > Rack Unit Config Changed	Config of rack unit [RACKUNIT] of asset strip [STRIPID] ('[STRIPNAME]') changed by user '[USERNAME]' to: LED Operation Mode '[LEDOPMODE]', LED Color '[LEDCOLOR]', LED Mode '[LEDMODE]'	
Asset Management > Blade Extension Overflow	Blade extension overflow occurred on strip [STRIPID] ('[STRIPNAME]').	Blade extension overflow cleared for strip [STRIPID] ('[STRIPNAME]').
Asset Management > Composite Asset Strip Composition Changed	Composition changed on composite asset strip [STRIPID] ('[STRIPNAME]').	
Card Reader Management > Card inserted	Card Reader with id '[CARDREADERID]' connected.	
Card Reader Management > Card Reader attached	Card Reader with id '[CARDREADERID]' disconnected.	
Card Reader Management > Card Reader detached	Card of type '[SMARTCARDTYPE]' with ID '[SMARTCARDID]' inserted.	

Event/context	Default message when the event = TRUE	Default message when the event = FALSE
Card Reader Management > Card removed	Card of type '[SMARTCARDTYPE]' with ID '[SMARTCARDID]' removed.	
Device > System started	System started.	
Device > System reset	System reset performed by user '[USERNAME]' from host '[USERIP]'.	
Device > Firmware validation failed	Firmware validation failed by user '[USERNAME]' from host '[USERIP]'.	
Device > Firmware update started	Firmware upgrade started from version '[OLDVERSION]' to version '[VERSION]' by user '[USERNAME]' from host '[USERIP]'.	
Device > Firmware update completed	Firmware upgraded successfully from version '[OLDVERSION]' to version '[VERSION]' by user '[USERNAME]' from host '[USERIP]'.	
Device > Firmware update failed	Firmware upgrade failed from version '[OLDVERSION]' to version '[VERSION]' by user '[USERNAME]' from host '[USERIP]'.	
Device > Device identification changed	Config parameter '[PARAMETER]' changed to '[VALUE]' by user '[USERNAME]' from host '[USERIP]'.	
Device > Device settings saved	Device settings saved from host '[USERIP]'.	
Device > Device settings restored	Device settings restored from host '[USERIP]'.	
Device > Data push failed	Data push to URL [DATAPUSH_URL] failed. [ERRORDESC].	
Device > Event log cleared	Event log cleared by user '[USERNAME]' from host '[USERIP]'.	
Device > Bulk configuration saved	Bulk configuration saved from host '[USERIP]'.	
Device > Bulk configuration copied	Bulk configuration copied from host '[USERIP]'.	

Event/context	Default message when the event = TRUE	Default message when the event = FALSE
Device > Network interface link state is up	The [IFNAME] network interface link is now up.	The [IFNAME] network interface link is now down.
Device > Peripheral Device Firmware Update	Firmware update for peripheral device [EXTSENSORSERIAL] from [OLDVERSION] to [VERSION] [SENSORSTATENAME].	
Device > Sending SMTP message failed	Sending SMTP message to '[RECIPIENTS]' using server '[SERVER]' failed.	
Device > Sending SNMP inform failed or no response	Sending SNMP inform to manager [SNMPMANAGER]:[SNMPMANAGERPORT] failed or no response. [ERRORDESC].	
Device > Sending Syslog message failed	Sending Syslog message to server [SYSLOGSERVER]:[SYSLOGPORT] [[SYSLOGTRANSPORTPROTO]] failed. [ERRORDESC].	
Device > Sending SMS message failed	Sending SMS message to '[PHONENUMBER]' failed.	
Device > An LDAP error occurred	An LDAP error occurred: [LDAPERRORDESC].	
Device > An Radius error occurred	An Radius error occurred: [RADIUSERRORDESC].	
Device > Unknown peripheral device attached	An unknown peripheral device with rom code '[ROMCODE]' was attached at position '[PERIPHDEVPOSITION]'.	
Device > USB slave connected	USB slave connected.	USB slave disconnected.
Device > WLAN authentication over TLS with incorrect system clock	Established connection to wireless network '[SSID]' via Access Point with BSSID '[BSSID]' using '[AUTHPROTO]' authentication with incorrect system clock.	
Energywise > Enabled	User '[USERNAME]' from host '[USERIP]' enabled EnergyWise.	User '[USERNAME]' from host '[USERIP]' disabled EnergyWise.

Event/context	Default message when the event = TRUE	Default message when the event = FALSE
Peripheral Device Slot > * > Numeric Sensor > Unavailable	Peripheral device '[EXTSENSORNAME]' in slot '[EXTSENSOR SLOT]' unavailable.	Peripheral device '[EXTSENSORNAME]' in slot '[EXTSENSOR SLOT]' available.
Peripheral Device Slot > * > Numeric Sensor > Above upper critical threshold	Peripheral device '[EXTSENSORNAME]' in slot '[EXTSENSOR SLOT]' asserted 'above upper critical' at [READING].	Peripheral device '[EXTSENSORNAME]' in slot '[EXTSENSOR SLOT]' deasserted 'above upper critical' at [READING].
Peripheral Device Slot > * > Numeric Sensor > Above upper warning threshold	Peripheral device '[EXTSENSORNAME]' in slot '[EXTSENSOR SLOT]' asserted 'above upper warning' at [READING].	Peripheral device '[EXTSENSORNAME]' in slot '[EXTSENSOR SLOT]' deasserted 'above upper warning' at [READING].
Peripheral Device Slot > * > Numeric Sensor > Below lower warning threshold	Peripheral device '[EXTSENSORNAME]' in slot '[EXTSENSOR SLOT]' asserted 'below lower warning' at [READING].	Peripheral device '[EXTSENSORNAME]' in slot '[EXTSENSOR SLOT]' deasserted 'below lower warning' at [READING].
Peripheral Device Slot > * > Numeric Sensor > Below lower critical threshold	Peripheral device '[EXTSENSORNAME]' in slot '[EXTSENSOR SLOT]' asserted 'below lower critical' at [READING].	Peripheral device '[EXTSENSORNAME]' in slot '[EXTSENSOR SLOT]' deasserted 'below lower critical' at [READING].
Peripheral Device Slot > * > State Sensor/Actuator > Unavailable	Peripheral device '[EXTSENSORNAME]' in slot '[EXTSENSOR SLOT]' unavailable.	Peripheral device '[EXTSENSORNAME]' in slot '[EXTSENSOR SLOT]' available.
Peripheral Device Slot > * > State Sensor/Actuator > Alarmed/Open/On	Peripheral device '[EXTSENSORNAME]' in slot [EXTSENSOR SLOT] is [SENSORSTATENAME].	Peripheral device '[EXTSENSORNAME]' in slot [EXTSENSOR SLOT] is [SENSORSTATENAME].
Inlet > * > Enabled	Inlet '[INLET]' has been enabled by user '[USERNAME]' from host '[USERIP]'.	Inlet '[INLET]' has been disabled by user '[USERNAME]' from host '[USERIP]'.
Inlet > * > Sensor > * > Unavailable	Sensor '[INLETSSENSOR]' on inlet '[INLET]' unavailable.	Sensor '[INLETSSENSOR]' on inlet '[INLET]' available.
Inlet > * > Sensor > * > Above upper critical threshold	Sensor '[INLETSSENSOR]' on inlet '[INLET]' asserted 'above upper critical'.	Sensor '[INLETSSENSOR]' on inlet '[INLET]' deasserted 'above upper critical'.
Inlet > * > Sensor > * > Above	Sensor '[INLETSSENSOR]' on inlet	Sensor '[INLETSSENSOR]' on inlet

Event/context	Default message when the event = TRUE	Default message when the event = FALSE
upper warning threshold	'[INLET]' asserted 'above upper warning'.	'[INLET]' deasserted 'above upper warning'.
Inlet > * > Sensor > * > Below lower warning threshold	Sensor '[INLETSensor]' on inlet '[INLET]' asserted 'below lower warning'.	Sensor '[INLETSensor]' on inlet '[INLET]' deasserted 'below lower warning'.
Inlet > * > Sensor > * > Below lower critical threshold	Sensor '[INLETSensor]' on inlet '[INLET]' asserted 'below lower critical'.	Sensor '[INLETSensor]' on inlet '[INLET]' deasserted 'below lower critical'.
Inlet > * > Sensor > Active Energy > Reset	Sensor '[INLETSensor]' on inlet '[INLET]' has been reset by user '[USERNAME]' from host '[USERIP]'.	
Modem > Dial-in link established	An incoming call from caller '[CALLERID]' was received.	The incoming call from caller '[CALLERID]' was disconnected: [CALLENDREASON].
Modem > Modem attached	A [MODEMTYPE] modem was attached.	
Modem > Modem detached	A [MODEMTYPE] modem was removed.	
Outlet > * > Power control > Powered on	Outlet '[OUTLET]' has been powered on by user '[USERNAME]' from host '[USERIP]'.	
Outlet > * > Power control > Powered off	Outlet '[OUTLET]' has been powered off by user '[USERNAME]' from host '[USERIP]'.	
Outlet > * > Power control > Power cycled	Outlet '[OUTLET]' power cycle initiated by user '[USERNAME]' from host '[USERIP]'.	
Outlet > * > Sensor > * > Unavailable	Sensor '[OUTLETSensor]' on outlet '[OUTLET]' unavailable.	Sensor '[OUTLETSensor]' on outlet '[OUTLET]' available.
Outlet > * > Sensor > * > Above upper critical threshold	Sensor '[OUTLETSensor]' on outlet '[OUTLET]' asserted 'above upper critical'.	Sensor '[OUTLETSensor]' on outlet '[OUTLET]' deasserted 'above upper critical'.
Outlet > * > Sensor > * > Above upper warning threshold	Sensor '[OUTLETSensor]' on outlet '[OUTLET]' asserted 'above upper warning'.	Sensor '[OUTLETSensor]' on outlet '[OUTLET]' deasserted 'above upper warning'.

Event/context	Default message when the event = TRUE	Default message when the event = FALSE
Outlet > * > Sensor > * > Below lower warning threshold	Sensor '[OUTLETSENSOR]' on outlet '[OUTLET]' asserted 'below lower warning'.	Sensor '[OUTLETSENSOR]' on outlet '[OUTLET]' deasserted 'below lower warning'.
Outlet > * > Sensor > * > Below lower critical threshold	Sensor '[OUTLETSENSOR]' on outlet '[OUTLET]' asserted 'below lower critical'.	Sensor '[OUTLETSENSOR]' on outlet '[OUTLET]' deasserted 'below lower critical'.
Outlet > * > Sensor > Active Energy > Reset	Sensor '[OUTLETSENSOR]' on outlet '[OUTLET]' has been reset by user '[USERNAME]' from host '[USERIP]'.	
Outlet > * > Sensor > Outlet State > On	Outlet '[OUTLET]' state changed to on.	Outlet '[OUTLET]' state changed to off.
Outlet > * > Pole > * > Sensor > Unavailable	Sensor '[POLESENSOR]' on pole '[OUTLETPOLE]' of outlet '[OUTLET]' unavailable.	Sensor '[POLESENSOR]' on pole '[OUTLETPOLE]' of outlet '[OUTLET]' available.
Outlet > * > Pole > * > Sensor > Above upper critical threshold	Sensor '[POLESENSOR]' on pole '[OUTLETPOLE]' of outlet '[OUTLET]' asserted 'above upper critical'.	Sensor '[POLESENSOR]' on pole '[OUTLETPOLE]' of outlet '[OUTLET]' deasserted 'above upper critical'.
Outlet > * > Pole > * > Sensor > Above upper warning threshold	Sensor '[POLESENSOR]' on pole '[OUTLETPOLE]' of outlet '[OUTLET]' asserted 'above upper warning'.	Sensor '[POLESENSOR]' on pole '[OUTLETPOLE]' of outlet '[OUTLET]' deasserted 'above upper warning'.
Outlet > * > Pole > * > Sensor > Below lower warning threshold	Sensor '[POLESENSOR]' on pole '[OUTLETPOLE]' of outlet '[OUTLET]' asserted 'below lower warning'.	Sensor '[POLESENSOR]' on pole '[OUTLETPOLE]' of outlet '[OUTLET]' deasserted 'below lower warning'.
Outlet > * > Pole > * > Sensor > Below lower critical threshold	Sensor '[POLESENSOR]' on pole '[OUTLETPOLE]' of outlet '[OUTLET]' asserted 'below lower critical'.	Sensor '[POLESENSOR]' on pole '[OUTLETPOLE]' of outlet '[OUTLET]' deasserted 'below lower critical'.
Overcurrent Protector > * > Sensor > * > Unavailable	Sensor '[OCPSSENSOR]' on overcurrent protector '[OCP]' unavailable.	Sensor '[OCPSSENSOR]' on overcurrent protector '[OCP]' available.
Overcurrent Protector > * > Sensor > * > Above upper critical threshold	Sensor '[OCPSSENSOR]' on overcurrent protector '[OCP]' asserted 'above upper critical'.	Sensor '[OCPSSENSOR]' on overcurrent protector '[OCP]' deasserted 'above upper critical'.

Event/context	Default message when the event = TRUE	Default message when the event = FALSE
Overcurrent Protector > * > Sensor > * > Above upper warning threshold	Sensor '[OCSENSOR]' on overcurrent protector '[OCP]' asserted 'above upper warning'.	Sensor '[OCSENSOR]' on overcurrent protector '[OCP]' deasserted 'above upper warning'.
Overcurrent Protector > * > Sensor > * > Below lower warning threshold	Sensor '[OCSENSOR]' on overcurrent protector '[OCP]' asserted 'below lower warning'.	Sensor '[OCSENSOR]' on overcurrent protector '[OCP]' deasserted 'below lower warning'.
Overcurrent Protector > * > Sensor > * > Below lower critical threshold	Sensor '[OCSENSOR]' on overcurrent protector '[OCP]' asserted 'below lower critical'.	Sensor '[OCSENSOR]' on overcurrent protector '[OCP]' deasserted 'below lower critical'.
Overcurrent Protector > * > Sensor > Trip > Open	Sensor '[OCSENSOR]' on overcurrent protector '[OCP]' is open.	Sensor '[OCSENSOR]' on overcurrent protector '[OCP]' is closed.
PDU > Load Shedding > Started	PX placed in Load Shedding Mode by user '[USERNAME]' from host '[USERIP]'.	PX removed from Load Shedding Mode by user '[USERNAME]' from host '[USERIP]'.
PDU > Sensor > +12V Supply 1 Status > fault	Global sensor 'powerSupplyStatus1' entered fault state.	PDU > Sensor > +12V Supply 1 Status > fault
PDU > Sensor > +12V Supply 1 Status > Unavailable	Global sensor 'powerSupplyStatus1' unavailable.	Global sensor 'powerSupplyStatus1' available.
Server Monitoring > * > Error	Error monitoring server '[MONITOREDHOST]': [ERRORDESC]	
Server Monitoring > * > Monitored	Server '[SERVER]' is now being monitored.	Server '[SERVER]' is no longer being monitored.
Server Monitoring > * > Unreachable	Server '[SERVER]' is unreachable.	Server '[SERVER]' is reachable.
Server Monitoring > * > Unrecoverable	Connection to server '[MONITOREDHOST]' could not be restored.	
User Activity > * > User logon state	User '[USERNAME]' from host '[USERIP]' logged in.	User '[USERNAME]' from host '[USERIP]' logged out.
User Activity > * > Authentication failure	Authentication failed for user '[USERNAME]' from host '[USERIP]'.	
User Activity > * > User accepted the Restricted Service Agreement	User '[USERNAME]' from host '[USERIP]' accepted the Restricted Service Agreement.	User '[USERNAME]' from host '[USERIP]' declined the Restricted Service Agreement.

Event/context	Default message when the event = TRUE	Default message when the event = FALSE
User Activity > * > User blocked	User '[USERNAME]' from host '[USERIP]' was blocked.	
User Activity > * > Session timeout	Session of user '[USERNAME]' from host '[USERIP]' timed out.	
User Administration > User added	User '[TARGETUSER]' added by user '[USERNAME]' from host '[USERIP]'.	
User Administration > User modified	User '[TARGETUSER]' modified by user '[USERNAME]' from host '[USERIP]'.	
User Administration > User deleted	User '[TARGETUSER]' deleted by user '[USERNAME]' from host '[USERIP]'.	
User Administration > Password changed	Password of user '[TARGETUSER]' changed by user '[USERNAME]' from host '[USERIP]'.	
User Administration > Password settings changed	Password settings changed by user '[USERNAME]' from host '[USERIP]'.	
User Administration > Role added	Role '[TARGETROLE]' added by user '[USERNAME]' from host '[USERIP]'.	
User Administration > Role modified	Role '[TARGETROLE]' modified by user '[USERNAME]' from host '[USERIP]'.	
User Administration > Role deleted	Role '[TARGETROLE]' deleted by user '[USERNAME]' from host '[USERIP]'.	
Webcam Management > Webcam attached	Webcam '[WEBCAMNAME]' ('[WEBCAMUVCID]') added to port '[WEBCAMUSBPORT]'.	
Webcam Management > Webcam detached	Webcam '[WEBCAMNAME]' ('[WEBCAMUVCID]') removed from port '[WEBCAMUSBPORT]'.	
Webcam Management > Webcam settings changed	Webcam '[WEBCAMNAME]' settings changed by user '[USERNAME]'.	
LHX/SHX > Connected	LHX has been connected to [PORTTYPE] port [PORTID].	LHX has been disconnected from [PORTTYPE] port [PORTID].
LHX/SHX > Operational State	LHX connected to [PORTTYPE] port [PORTID] has been switched on.	LHX connected to [PORTTYPE] port [PORTID] has been switched off.

Event/context	Default message when the event = TRUE	Default message when the event = FALSE
LHX/SHX > Sensor > Unavailable	Sensor '[LHXSENSORID]' on LHX at [PORTTYPE] port '[PORTID]' unavailable.	Sensor '[LHXSENSORID]' on LHX at [PORTTYPE] port '[PORTID]' available.
LHX/SHX > Sensor > Above upper critical threshold	Sensor '[LHXSENSORID]' on LHX at [PORTTYPE] port '[PORTID]' asserted 'above upper critical'.	Sensor '[LHXSENSORID]' on LHX at [PORTTYPE] port '[PORTID]' deasserted 'above upper critical'.
LHX/SHX > Sensor > Above upper warning threshold	Sensor '[LHXSENSORID]' on LHX at [PORTTYPE] port '[PORTID]' asserted 'above upper warning'.	Sensor '[LHXSENSORID]' on LHX at [PORTTYPE] port '[PORTID]' deasserted 'above upper warning'.
LHX/SHX > Sensor > Below lower warning threshold	Sensor '[LHXSENSORID]' on LHX at [PORTTYPE] port '[PORTID]' asserted 'below lower warning'.	Sensor '[LHXSENSORID]' on LHX at [PORTTYPE] port '[PORTID]' deasserted 'below lower warning'.
LHX/SHX > Sensor > Below lower critical threshold	Sensor '[LHXSENSORID]' on LHX at [PORTTYPE] port '[PORTID]' asserted 'below lower critical'.	Sensor '[LHXSENSORID]' on LHX at [PORTTYPE] port '[PORTID]' deasserted 'below lower critical'.
LHX/SHX > Base Electronics Failure	The base electronics on LHX at [PORTTYPE] port '[PORTID]' failed.	
LHX/SHX > Condenser Pump Failure	The condenser pump on LHX at [PORTTYPE] port '[PORTID]' failed.	The condenser pump on LHX at [PORTTYPE] port '[PORTID]' is back to normal.
LHX/SHX > Emergency Cooling	Emergency cooling on LHX at [PORTTYPE] port '[PORTID]' was activated.	Emergency cooling on LHX at [PORTTYPE] port '[PORTID]' was deactivated.
LHX/SHX > Maximum cooling request	Maximum cooling was requested for LHX at [PORTTYPE] port '[PORTID]'.	Maximum cooling is not any more requested for LHX at [PORTTYPE] port '[PORTID]'.
LHX/SHX > Parameter Data Loss	Data loss in parameter memory was detected on LHX at [PORTTYPE] port '[PORTID]'.	
LHX/SHX > ST-Bus Communication Error	An ST-Bus communication error was detected on LHX at [PORTTYPE] port '[PORTID]'.	
LHX/SHX > Collective fault	A collective fault occurred on LHX at [PORTTYPE] port '[PORTID]'.	
LHX/SHX > Door Contact	The door of LHX at [PORTTYPE] port '[PORTID]' was opened.	The door of LHX at [PORTTYPE] port '[PORTID]' was closed.

Event/context	Default message when the event = TRUE	Default message when the event = FALSE
LHX/SHX > Sensor Failure	A sensor failure (broken or short circuit) occurred on LHX at [PORTTYPE] port '[PORTID]' at sensor '[LHXSENSORID]'.	
LHX/SHX > Fan Failure	A fan motor failure occurred on LHX at [PORTTYPE] port '[PORTID]' at fan '[LHXFANID]'.	
LHX/SHX > Power Supply Failure	A power supply failure occurred on LHX at [PORTTYPE] port '[PORTID]' at power supply '[LHXPOWERSUPPLYID]'.	
LHX/SHX > Threshold Air Inlet	The air inlet temperature threshold on LHX at [PORTTYPE] port '[PORTID]' was crossed.	The air inlet temperature on LHX at [PORTTYPE] port '[PORTID]' is within thresholds.
LHX/SHX > Threshold Air Outlet	The air outlet temperature threshold on LHX at [PORTTYPE] port '[PORTID]' was crossed.	The air outlet temperature on LHX at [PORTTYPE] port '[PORTID]' is within thresholds.
LHX/SHX > Threshold Water Inlet	The water inlet temperature threshold on LHX at [PORTTYPE] port '[PORTID]' was crossed.	The water inlet temperature on LHX at [PORTTYPE] port '[PORTID]' is within thresholds.
LHX/SHX > Threshold Water Outlet	The water outlet temperature threshold on LHX at [PORTTYPE] port '[PORTID]' was crossed.	The water outlet temperature on LHX at [PORTTYPE] port '[PORTID]' is within thresholds.
LHX/SHX > Voltage Low	The supply voltage on LHX at [PORTTYPE] port '[PORTID]' is low.	The supply voltage on LHX at [PORTTYPE] port '[PORTID]' is back to normal.
LHX/SHX > Threshold Humidity	The humidity threshold on LHX at [PORTTYPE] port '[PORTID]' was crossed.	The humidity on LHX at [PORTTYPE] port '[PORTID]' is within thresholds.
LHX/SHX > External Water Cooling Failure	An external water cooling failure occurred on LHX at [PORTTYPE] port '[PORTID]'.	
LHX/SHX > Water Leak	Water leakage was detected on LHX at [PORTTYPE] port '[PORTID]'.	

The asterisk symbol (*) represents anything you select for the 'trigger' events.

Available Actions

The PX3 comes with three built-in actions, which cannot be deleted. You can create additional actions for responding to different events.

► Built-in actions:

- *System Event Log Action:*

This action records the selected event in the internal log when the event occurs.

- *System SNMP Notification Action:*

This action sends SNMP notifications to one or multiple IP addresses after the selected event occurs.

*Note: No IP addresses are specified for this notification action by default so you must enter IP addresses before applying this action to any event rule. See **Editing or Deleting a Rule/Action** (on page 312). Any changes made to the 'SNMP Notifications' section on the SNMP page will update the settings of the System SNMP Notification Action, and vice versa. See **Configuring SNMP Settings** (on page 241).*

- *System Tamper Alarm:*

This action causes the PX3 to show the alarm for the DX tamper sensor, if any, on the Dashboard page until a person acknowledges it. By default, this action has been assigned to the built-in tamper detection event rules. For information on acknowledging an alarm, see **Dashboard - Alarms** (on page 143).

► Actions you can create:

1. Choose Device Settings > Event Rules > **+ New Action**.
2. Click the Action field to select an action type from the list.
3. Below is the list of available actions.

Note: The "Change load shedding state" and "Switch outlets" options are only available for outlet-switching capable models.

Action	Function
Alarm	Requires the user to acknowledge the alert after it is generated. If needed, you can have the alert notifications regularly generated until a person takes the acknowledgment action. See Alarm (on page 291).
Change load shedding state	Enters or quits the load shedding mode. See Change Load Shedding State (on page 293).

Action	Function
Execute an action group	Creates a group of actions comprising existing actions. See Action Group (on page 292).
External beeper	Enables or disables the connected external beeper, or causes it to enter an alarm cycle. See External Beeper (on page 293).
Internal beeper	Turns on or off the internal beeper. See Internal Beeper (on page 294).
Log event message	Records the selected events in the internal log. See Log an Event Message (on page 294).
Push out sensor readings	Sends internal sensor log, environmental sensor log or asset management strip data to a remote server using HTTP POST requests. See Push Out Sensor Readings (on page 294).
Record snapshots to webcam storage	Makes a connected webcam start or stop taking snapshots. See Record Snapshots to Webcam Storage (on page 295).
Request LHX/SHX maximum cooling	Applies the maximum cooling to the LHX/SHX device. See Request LHX/SHX Maximum Cooling (on page 296). This option is available only when the Schroff LHX/SHX support has been enabled.
Send email	Emails a textual message. See Send Email (on page 296).
Send sensor report	Reports the readings or status of the selected sensors, including internal or external sensors. See Send Sensor Report (on page 297).
Send SMS message	Sends a message to a mobile phone. See Send SMS Message (on page 299).
Send snapshots via email	Emails the snapshots captured by a connected Logitech® webcam (if available). See Send Snapshots via Email (on page 300).
Send SNMP notification	Sends SNMP traps or informs to one or multiple SNMP destinations. See Send an SNMP Notification (on page 300).

Action	Function
Start/stop Lua script	If you are a developer who can create a Lua script, you can upload it to the PX3, and have the PX3 automatically perform or stop the script in response to an event. See <i>Start or Stop a Lua Script</i> (on page 302).
Switch LHX/SHX	Switches on or off the LHX/SHX device. See <i>Switch LHX/SHX</i> (on page 303). This option is available only when the Schroff LHX/SHX support has been enabled.
Switch outlets	Switches on, off or cycles the power to the specified outlet(s). See <i>Switch Outlets</i> (on page 303).
Switch peripheral actuator	Switches on or off the mechanism or system connected to the specified actuator. See <i>Switch Peripheral Actuator</i> (on page 304).
Syslog message	Makes the PX3 automatically forward event messages to the specified syslog server. See <i>Syslog Message</i> (on page 305).

4. Enter the information as needed and click Create.
5. Then you can assign the newly-created action to an event rule or schedule it. See ***Event Rules and Actions*** (on page 272).

Alarm

The Alarm is an action that requires users to acknowledge an alert. This helps ensure that the user is aware of the alert.

If the Alarm action has been included in a specific event rule and no one acknowledges that alert after it occurs, the PX3 resends or regenerates an alert notification regularly until the alert is acknowledged or the maximum number of alert notifications is sent.

For information on acknowledging an alert, see ***Dashboard*** (on page 135).

▶ **Operation:**

1. Choose Device Settings > Event Rules > **+ New Action**.
2. Select Alarm from the Action list.
3. In the Alarm Notifications list box, specify one or multiple ways to issue the alert notifications. Available methods vary, depending on how many notification-based actions have been created.
Notification-based action types include:

- External beeper
- Syslog message
- Send email
- Send SMS message
- Internal beeper

If no appropriate actions are available, create them first.

- a. To select any methods, select them one by one in the Available field.

To add all available methods, simply click Select All.

- b. To delete any methods, click a method's  in the Selected field.

To remove all methods, simply click Deselect All.

4. To enable the notification-resending feature, select the "Enable Re-scheduling of Alarm Notifications" checkbox.
5. In the "Re-scheduling Period" field, specify the time interval (in minutes) at which the alert notification is resent or regenerated regularly.
6. In the "Re-scheduling Limit" field, specify the maximum number of times the alert notification is resent. Values range from 1 to infinite.
7. **(Optional)** You can instruct the PX3 to send the acknowledgment notification after the alarm is acknowledged in the Acknowledgment Notifications field. Available methods are identical to those for generating alarm notifications.
 - a. In the Available field, select desired methods one by one, or click Select All. See step 3 for details.
 - b. In the Selected field, click any method's  to remove unnecessary ones, or click Deselect All.

Action Group

You can create an action group that performs up to 32 actions. After creating such an action group, you can easily assign this set of actions to any event rule rather than selecting all needed actions one by one per rule.

If the needed action is not available yet, create it first. See ***Available Actions*** (on page 289).

▶ Operation:

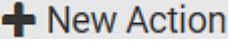
1. Choose Device Settings > Event Rules > .
2. Select "Execute an action group" from the Action list.

3. To select any action(s), select them one by one from the Available Actions list.
 - To select all available actions, click Select All.
4. To remove any action(s) from the Selected Actions field, click that action's .
 - To remove all actions, click Deselect All.

Change Load Shedding State

The "Change load shedding state" action is available only when your PX3 is able to control outlet power. Use this action to activate or deactivate the load shedding mode for responding to a specific event. For additional information, see ***Load Shedding Mode*** (on page 164).

▶ Operation:

1. Choose Device Settings > Event Rules >  **New Action**.
2. Select "Change load shedding state" from the Action list.
3. In the Operation field, select either one below:
 - Start Load Shedding: Enters the load shedding mode when the specified event occurs.
 - Stop Load Shedding: Quits the load shedding mode when the specified event occurs.

External Beeper

If an external beeper is connected to the PX3, the PX3 can change the beeper's behavior or status to respond to a certain event.

▶ To control the connected external beeper:

1. Choose Device Settings > Event Rules >  **New Action**.
2. Select "External beeper" from the Action list.
3. In the Beeper Port field, select the port where the external beeper is connected. This port is the FEATURE port.
4. In the Beeper Action field, select an action for the external beeper to carry out.
 - Alarm: Causes the external beeper to sound an alarm cycle every 20 seconds - stays on for 0.7 seconds and then off for 19.3 seconds.
 - On: Turns on the external beeper so that it buzzes continuously.
 - Off: Turns off the external beeper so that it stops buzzing.

Warning: If you create an event rule for the external beeper but disconnect it when an event causes it to beep, the beeper no longer beeps after it is re-connected even though the event triggering the beeping action remains asserted.

Internal Beeper

You can have the built-in beeper of the PX3 turned on or off when a certain event occurs.

▶ **Operation:**

1. Choose Device Settings > Event Rules > **+ New Action**.
2. Select "Internal beeper" from the Action list.
3. Select an option from the Operation field.
 - Turn Beeper On: Turns on the internal beeper to make it buzz.
 - Turn Beeper Off: Turns off the internal beeper to make it stop buzzing.

Log an Event Message

The option "Log event message" records the selected events in the internal log.

The default log message generated for each type of event is available in the section titled **Default Log Messages** (on page 278).

Push Out Sensor Readings

You can configure the PX3 to push sensor log to a remote server after a certain event occurs, including logs of internal sensors, environmental sensors and actuators.

If you have connected Raritan's asset strips to the PX3, you can also configure the PX3 to push the data to a server.

Before creating this action, make sure that you have properly defined the destination servers and the data to be sent on the Data Push page. See **Configuring Data Push Settings** (on page 318).

*Tip: To send the data at a regular interval, schedule this action. See **Scheduling an Action** (on page 306). Note that the "Asset management log" is generated only when there are changes made to any asset strips or asset tags, such as connection or disconnection events.*

▶ **Operation:**

1. Choose Device Settings > Event Rules > **+ New Action**.

2. Select "Push out sensor readings" from the Action list.
3. Select a server or host which receives the asset strip data or sensor log in the Destination field.
 - If the desired destination is not available yet, go to the Data Push page to specify it.

Record Snapshots to Webcam Storage

This option allows you to define an action that starts or stops a specific webcam from taking snapshots.

Per default the snapshots are stored on the PX3. You can specify a remote server to store snapshots. See ***Viewing Saved Snapshots and Managing Storage*** (on page 355).

▶ Operation:

1. Choose Device Settings > Event Rules > **+ New Action**.
2. Select "Record snapshots to webcam storage" from the Action list.
3. Select a webcam in the Webcam field.
4. Select the action to perform - "Start recording" or "Stop recording."

If "Start recording" is selected, adjust the values of the following:

- Number of Snapshots - the number of snapshots to be taken when the event occurs.

The maximum amount of snapshots that can be stored on the PX3 is 10. If you set it for a number greater than 10 and the storage location is on the PX3, after the 10th snapshot is taken and stored, the oldest snapshots are overwritten. Storing snapshots on a remote server does not have such a limitation.

- Time Before First Snapshot - the amount of time in seconds between when the event is triggered and the webcam begins taking snapshots.
- Time Between Snapshots - the amount of time in seconds between when each snapshot is taken.

Request LHX/SHX Maximum Cooling

If Schroff LHX/SHX Support is enabled, the LHX/SHX-related actions will be available. See ***Miscellaneous*** (on page 332).

The "Request LHX/SHX Maximum Cooling" action applies the maximum cooling to the SHX-30 device only. The LHX-20 and LHX-40 devices do not support this feature.

In the maximum cooling mode, an SHX-30 device runs at 100% fan speed and the cold water valve is open 100%.

► **Operation:**

1. Choose Device Settings > Event Rules > **+ New Action**.
2. Select "Request LHX/SHX Maximum Cooling" from the Action list.
3. In the Available LHX/SHX field, select the desired SHX-30 device one by one, or click Select All.
4. To remove any SHX-30 device from the Selected LHX/SHX field, click that device's **X** or click Deselect All.

Send Email

You can configure emails to be sent when an event occurs and can customize the message.

Messages consist of a combination of free text and PX3 placeholders. The placeholders represent information is pulled from the PX3 and inserted into the message.

For example:

```
[USERNAME] logged into the device on [TIMESTAMP]
```

translates to

```
JQPublic logged into the device on 2012-January-30 21:00
```

For a list and definition of available variables, see ***Email and SMS Message Placeholders*** (on page 309).

► **Operation:**

1. Choose Device Settings > Event Rules > **+ New Action**.
2. Select "Send email" from the Action list.
3. In the "Recipient Email Addresses" field, specify the email address(es) of the recipient(s). Use a comma to separate multiple email addresses.
4. To use the SMTP server specified on the SMTP Server page, make sure the "Use custom SMTP Server" checkbox is NOT selected.

To use a different SMTP server, select this checkbox. The fields for customized SMTP settings appear. For information on each field, see *Configuring SMTP Settings* (on page 242).

Default messages are sent based on the event. For a list of default log messages and events that trigger them, see *Default Log Messages* (on page 278).

5. If needed, select the Use Custom Log Message checkbox, and then create a custom message up to 1024 characters in the provided field.
 - When clicking anywhere inside the text box, the Event Context Information displays, showing a list of placeholders and their definitions. Just click the desired placeholder. For details, see *Email and SMS Message Placeholders* (on page 309).
 - To start a new line in the text box, press Enter.
 - If needed, you can resize the text box by dragging the bottom-right corner.

Send Sensor Report

You may set the PX3 so that it automatically reports the latest readings or states of one or multiple sensors by sending a message or email or simply recording the report in a log. These sensors can be either internal or environmental sensors as listed below.

- Inlet sensors, including RMS current, RMS voltage, active power, apparent power, power factor and active energy.
- Outlet sensors, including RMS current, RMS voltage, active power, apparent power, power factor, active energy and outlet state (for outlet-switching capable PDUs only).
- Overcurrent protector sensors, including RMS current and tripping state.
- Peripheral device sensors, which can be any Raritan environmental sensor packages connected to the PX3, such as temperature or humidity sensors.

An example of this action is available in the section titled *Send Sensor Report Example* (on page 308).

▶ Operation:

1. Choose Device Settings > Event Rules > **+ New Action**.
2. Select "Send sensor report" from the Action list.
3. In the Destination Actions section, select the method(s) to report sensor readings or states. The number of available methods varies, depending on how many messaging actions have been created.

The messaging action types include:

- Log event message

- Syslog message
 - Send email
 - Send SMS message
 - a. If no messaging actions are available, create them now. See **Available Actions** (on page 289).
 - b. To select any methods, select them one by one in the Available field.
To add all available methods, simply click Select All.
 - c. To delete any methods, click a method's **X** in the Selected field.
To remove all methods, simply click Deselect All.
4. In the Available Sensors field, select the desired target's sensor.

- a. Click the first  to select a target component from the list.

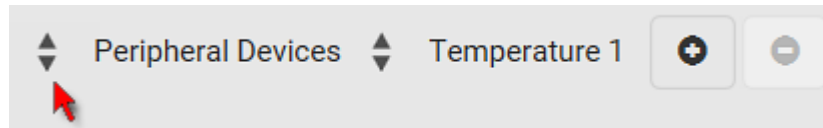



- b. Click the second  to select the specific sensor for the target from the list.



- c. Click  to add the selected sensor to the Report Sensors list box.

For example, to monitor the current reading of the Inlet 1, select Inlet 1 from the left field, and then select RMS Current from the right field.

5. To report additional sensors simultaneously, repeat the above step to add more sensors.
- To remove any sensor from the Report Sensors list box, select it  and click . To make multiple selections, press Ctrl+click or Shift+click to highlight multiple ones.
6. To immediately send out the sensor report, click Send Report Now.

*Tip: When intending to send a sensor report using custom messages, use the placeholder [SENSORREPORT] to report sensor readings. See **Email and SMS Message Placeholders** (on page 309).*

Send SMS Message

You can configure SMS messages to be sent when an event occurs and can customize the message.

Messages consist of a combination of free text and PX3 placeholders. The placeholders represent information which is pulled from the PX3 and inserted into the message.

A supported modem, such as the Cinterion® GSM MC52i modem, must be plugged into the PX3 in order to send SMS messages. See **Connecting a GSM Modem** (on page 82).

Note: The PX3 cannot receive SMS messages.

For example:

[USERNAME] logged into the device on [TIMESTAMP]

translates to

JQPublic logged into the device on 2012-January-30 21:00

For a list and definition of available variables, see **Email and SMS Message Placeholders** (on page 309).

► **Operation:**

1. Choose Device Settings > Event Rules > **+ New Action**.
 2. Select "Send SMS message" from the Action list.
 3. In the Recipient Phone Number field, specify the phone number of the recipient.
 4. Select the Use Custom Log Message checkbox, and then create a custom message in the provided text box.
 - When clicking anywhere inside the text box, the Event Context Information displays, showing a list of placeholders and their definitions. Just click the desired placeholder. For details, see **Email and SMS Message Placeholders** (on page 309).
 - To start a new line in the text box, press Enter.
 - If needed, you can resize the text box by dragging the bottom-right corner.
-

Note: Only the 7-bit ASCII charset is supported for SMS messages.

Send Snapshots via Email

This option notifies one or multiple persons for the selected events by emailing snapshots or videos captured by a connected Logitech® webcam.

▶ **Operation:**

1. Choose Device Settings > Event Rules > **+ New Action**.
2. Select "Send snapshots via email" from the Action list.
3. In the "Recipient Email Addresses" field, specify the email address(es) of the recipient(s). Use a comma to separate multiple email addresses.
4. To use the SMTP server specified on the SMTP Server page, make sure the "Use custom SMTP Server" checkbox is NOT selected.
To use a different SMTP server, select this checkbox. The fields for customized SMTP settings appear. For information on each field, see ***Configuring SMTP Settings*** (on page 242).
5. Select the webcam that is capturing the images you want sent in the email.
6. Adjust the values of the following:
 - Number of Snapshots - the number of snapshots to be taken when the event occurs. For example, you can specify 10 images be taken once the event triggers the action.
 - Snapshots per Mail - the number of snapshots to be sent at one time in the email.
 - Time Before First Snapshot - the amount of time in seconds between when the event is triggered and the webcam begins taking snapshots.
 - Time Between Snapshots - the amount of time in seconds between when each snapshot is taken.

Send an SNMP Notification

This option sends an SNMP notification to one or multiple SNMP destinations.

▶ **Operation:**

1. Choose Device Settings > Event Rules > **+ New Action**.
2. Select "Send SNMP notification" from the Action list.
3. Select the type of SNMP notification. See either procedure below according to your selection.

► **To send SNMP v2c notifications:**

1. In the Notification Type field, select SNMPv2c Trap or SNMPv2c Inform.
2. For SNMP INFORM communications, leave the resend settings at their default or do the following:
 - a. In the Timeout field, specify the interval of time, in seconds, after which a new inform communication is resent if the first is not received. For example, resend a new inform communication once every 3 seconds.
 - b. In the Number of Retries field, specify the number of times you want to resend the inform communication if it fails. For example, inform communications are resent up to 5 times when the initial communication fails.
3. In the Host fields, enter the IP address of the device(s) you want to access. This is the address to which notifications are sent by the SNMP system agent.
4. In the Port fields, enter the port number used to access the device(s).
5. In the Community fields, enter the SNMP community string to access the device(s). The community is the group representing the PX3 and all SNMP management stations.

Tip: An SNMP v2c notification action permits only a maximum of three SNMP destinations. To assign more than three SNMP destinations to a specific rule, first create several SNMP v2c notification actions, each of which contains completely different SNMP destinations, and then add all of these SNMP v2c notification actions to the same rule.

► **To send SNMP v3 notifications:**

1. In the Notification Type field, select SNMPv3 Trap or SNMPv3 Inform.
2. For SNMP TRAPS, the engine ID is prepopulated.
3. For SNMP INFORM communications, leave the resend settings at their default or do the following:
 - a. In the Timeout field, specify the interval of time, in seconds, after which a new inform communication is resent if the first is not received. For example, resend a new inform communication once every 3 seconds.
 - b. In the Number of Retries field, specify the number of times you want to resend the inform communication if it fails. For example, inform communications are resent up to 5 times when the initial communication fails.

4. For both SNMP TRAPS and INFORMS, enter the following as needed and then click OK to apply the settings:
 - a. Host name
 - b. Port number
 - c. User ID for accessing the host -- make sure the User ID has the SNMPv3 permission.
 - d. Select the host security level

Security level	Description
"noAuthNoPriv"	Select this if no authorization or privacy protocols are needed.
"authNoPriv"	Select this if authorization is required but no privacy protocols are required. <ul style="list-style-type: none"> • Select the authentication protocol - MD5 or SHA • Enter the authentication passphrase and then confirm the authentication passphrase
"authPriv"	Select this if authentication and privacy protocols are required. <ul style="list-style-type: none"> • Select the authentication protocol - MD5 or SHA • Enter the authentication passphrase and confirm the authentication passphrase • Select the Privacy Protocol - DES or AES • Enter the privacy passphrase and then confirm the privacy passphrase

Start or Stop a Lua Script

If you have created or loaded a Lua script file into the PX3, you can have that script automatically run or stop in response to a specific event.

For instructions on creating or loading a Lua script into this product, see ***Lua Scripts*** (on page 327).

▶ **To automatically start or stop a Lua script:**

1. Choose Device Settings > Event Rules > **+ New Action**.
2. Select "Start/stop Lua script" from the Action list.
3. In the Operation field, select Start Script or Stop Script.
4. In the Script field, select the script that you want it to be started or stopped when an event occurs.

- No script is available if you have not created or loaded it into the PX3.
5. To apply different arguments than the default, do the following. Note that the newly-added arguments will override this script's default arguments.

 + Add argument

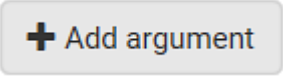
- a. Click .
- b. Type the key and value.
- c. Repeat the same steps to enter more arguments as needed.

- To remove any existing argument, click  adjacent to it.

Switch LHX/SHX

If Schroff LHX/SHX Support is enabled, the LHX/SHX-related actions will be available. See *Miscellaneous* (on page 332).

Use this action to switch the LHX/SHX on or off when, for example, temperature thresholds are reached.

▶ **Operation:**

1. Choose Device Settings > Event Rules > .
2. Select "Switch LHX/SHX" from the Action list.
3. In the Operation field, select Turn LHX/SHX On or Turn LHX/SHX Off.
4. In the Available LHX/SHX field, select the LHX/SHX device to be turned on or off. To select all available LHX/SHX devices, click Select All.

To remove any LHX/SHX device from the Selected LHX/SHX field, click that device's . To remove all devices, click Deselect All.

Switch Outlets

The "Switch outlets" action is available only when your PX3 is outlet-switching capable. This action turns on, off or power cycles a specific outlet.

▶ **Operation:**

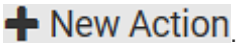
1. Choose Device Settings > Event Rules > .
2. Select "Switch outlets" from the Action list.
3. In the Operation field, select an operation for the selected outlet(s).
 - Turn Outlet On: Turns on the selected outlet(s).
 - Turn Outlet Off: Turns off the selected outlet(s).

- Cycle Outlet: Cycles power to the selected outlet(s).
- 4. To specify the outlet(s) where this action will be applied, select them one by one from the Available Outlets list.
 - To add all outlets, click Select All.
- 5. To remove any outlets from the Selected Outlets field, click that outlet's .

 - To remove all outlets, click Deselect All.



- 6. If "Turn Outlet On" or "Cycle Outlet" is selected in step 3, you can choose to select the "Use sequence order and delays" checkbox so that all selected outlets will follow the power-on sequence defined on the page of **Outlets** (on page 158).

Switch Peripheral Actuator

If you have any actuator connected to the PX3, you can set up the PX3 so it automatically turns on or off the system controlled by the actuator when a specific event occurs.

*Note: For information on connecting actuators, see **DX Sensor Packages** (on page 63).*

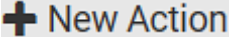
▶ Operation:

1. Choose Device Settings > Event Rules > .
2. Select "Switch peripheral actuator" from the Action list.
3. In the Operation field, select an operation for the selected actuator(s).
 - Turn On: Turns on the selected actuator(s).
 - Turn Off: Turns off the selected actuator(s).
4. To select the actuator(s) where this action will be applied, select them one by one from the Available Actuators list.
 - To add all actuators, click Select All.
5. To remove any selected actuator from the Selected Actuators field, click that actuator's .

 - To remove all actuators, click Deselect All.

Syslog Message

Use this action to automatically forward event messages to the specified syslog server. Determine the syslog transmission mechanism you prefer when setting it up - UDP, TCP or TLS over TCP.

The PX3 may or may not detect the syslog message transmission failure. If yes, it will log this syslog failure as well as the failure reason in the event log. See *Viewing or Clearing the Local Event Log* (on page 339).

▶ Operation:

1. Choose Device Settings > Event Rules > **+ New Action**.
2. Select "Syslog message" from the Action list.
3. In the Syslog Server field, specify the IP address to which the syslog is forwarded.
4. In the Transport Protocol field, select one of the syslog protocols: TCP, UDP or TCP+TLS. The default is UDP.

Transport protocols	Next steps
UDP	<ul style="list-style-type: none"> ▪ In the UDP Port field, type an appropriate port number. Default is 514. ▪ Select the "Legacy BSD Syslog Protocol" checkbox if applicable.
TCP	NO TLS certificate is required. Type an appropriate port number in the TCP Port field.
TCP+TLS	<p>A TLS certificate is required. Do the following:</p> <ol style="list-style-type: none"> a. Type an appropriate port number in the "TCP Port" field. Default is 6514. b. In the CA Certificate field, click Browse... to select a TLS certificate. After installing the certificate, you may: <ul style="list-style-type: none"> ▪ Click Show to view its contents. ▪ Click Remove to delete it if it is inappropriate. c. Determine whether to select the "Allow expired and not yet valid certificates" checkbox. <ul style="list-style-type: none"> ▪ To always send the event message to the specified syslog server as long as a TLS certificate is available, select this checkbox. ▪ To prevent the event message from being sent to the specified syslog server when any TLS certificate in the selected certificate chain is outdated or not valid yet, deselect this checkbox.



Scheduling an Action



An action can be regularly performed at a preset time interval instead of being triggered by a specific event. For example, you can make the PX3 report the reading or state of a specific sensor regularly by scheduling the "Send Sensor Report" action.

When scheduling an action, make sure you have a minimum of 1-minute buffer between this action's creation and first execution time. Otherwise, the scheduled action will NOT be performed at the specified time when the buffer time is too short. For example, if you want an action to be performed at 11:00 am, you should finish scheduling it at 10:59 am or earlier.

If the needed action is not available yet, create it first. See *Available Actions* (on page 289).

▶ Operation:

1. Choose Device Settings > Event Rules >  **New Scheduled Action**.
2. To select any action(s), select them one by one from the Available Actions list.
 - To select all available actions, click Select All.
3. To remove any action(s) from the Selected Actions field, click that action's .
- To remove all actions, click Deselect All.
4. Select the desired frequency in the Execution Time field, and then specify the time interval or a specific date and time in the field(s) that appear.

Execution time	Frequency settings
Minutes	<p>Click the Frequency field to select an option.</p> <p>The frequency ranges from every minute, every 5 minutes, every 10 minutes and so on until every 30 minutes.</p>
Hourly	<p>Type a value in the Minute field, which is set to either of the following:</p> <ul style="list-style-type: none"> ▪ The Minute field is set to 0 (zero). Then the action is performed at 1:00 am, 2:00 am, 3:00 am and so on. ▪ The Minute field is set to a non-zero value. For example, if it is set to 30, then the action is performed at 1:30 am, 2:30 am, 3:30 am and so on.
Daily	<p>Type values or click  .</p> <p>The time is measured in 12-hour format so you must correctly specify AM or PM by clicking the AM/PM button.</p> <div data-bbox="764 905 1122 1010" style="border: 1px solid #ccc; padding: 5px; display: inline-block; margin: 10px 0;"> 12 : 00 AM </div> <p>For example, if you specify 01:30PM, the action is performed at 13:30 pm every day.</p>
Weekly	<p>Both the day and time must be specified for the weekly option.</p> <ul style="list-style-type: none"> ▪ Days range from Sunday to Saturday. ▪ The time is measured in 12-hour format so you must correctly specify AM or PM by clicking the AM/PM button.
Monthly	<p>Both the date and time must be specified for the monthly option.</p> <ul style="list-style-type: none"> ▪ The dates range from 1 to 31. ▪ The time is measured in 12-hour format so you must correctly specify AM or PM by clicking the AM/PM button. <p>Note that NOT every month has the date 31, and February in particular does not have the date 30 and probably even 29. Check the calendar when selecting 29, 30 or 31.</p>

Execution time	Frequency settings
Yearly	This option requires three settings: <ul style="list-style-type: none"> ▪ Month - January through December. ▪ Day of month - 1 to 31. ▪ Time - the value is measured in 12-hour format so you must correctly specify AM or PM by clicking the AM/PM button.

An example of the scheduled action is available in the section titled **Send Sensor Report Example** (on page 308).

Send Sensor Report Example

To create a scheduled action for emailing a temperature sensor report hourly, it requires:

- A 'Send email' action
- A 'Send sensor report' action
- A timer - that is, the scheduled action

► **Steps:**

1. Click **+ New Action** to create a 'Send email' action that sends an email to the desired recipient(s). For details, see **Send Email** (on page 296).
 - In this example, this action is named *Email a Sensor Report*.
 - If intended, you can customize the email messages in this action.
2. Click **+ New Action** to create a 'Send sensor report' action that includes the 'Email a Sensor Report' action as its destination action. For details, see **Send Sensor Report** (on page 297).
 - In this example, this action is named *Send Temperature Sensor Readings*.
 - You can specify more than one temperature sensor as needed in this action.
3. Click **+ New Scheduled Action** to create a timer for performing the 'Send Temperature Sensor Readings' action hourly. For details, see **Scheduling an Action** (on page 306).
 - In this example, the timer is named *Hourly Temperature Sensor Reports*.
 - To perform the specified action at 12:30 pm, 01:30 pm, 02:30 pm, and so on, select Hourly, and set the Minute to 30.

Then the PX3 will send out an email containing the specified temperature sensor readings hourly every day.

Whenever you want the PX3 to stop sending the temperature report, simply deselect the Enabled checkbox in the timer.

Email and SMS Message Placeholders

Actions of "Send email" and "Send SMS message" allow you to customize event messages. See *Send Email* (on page 296) or *Send SMS Message* (on page 299).

When clicking anywhere inside the text box, the Event Context Information displays, showing a list of placeholders and their definitions. Simply drag the scroll bar and then click the desired placeholder to insert it into the custom message. Or you can type a keyword in the "search" box to quickly find the desired placeholder.

If wanted, you can resort the list by clicking the desired column header. See *Sorting a List* (on page 134).

To make the Event Context Information disappear, click anywhere outside its window.

Following are placeholders that can be used in custom messages.

Placeholder	Definition
[ACTIVEINLET]	The label of the newly activated inlet
[AMSBLADESLOTPOSITION]	The (horizontal) slot position, an action applies to
[AMSLEDCOLOR]	The RGB LED color
[AMSLEDMODE]	The LED indication mode
[AMSLEDOPMODE]	The LED operating mode
[AMSNAME]	The name of an asset strip
[AMSNUMBER]	The numeric ID of an asset strip
[AMSRACKUNITPOSITION]	The (vertical) rack unit position, an action applies to
[AMSSTATE]	The human readable state of an asset strip
[AMSTAGID]	The asset tag ID
[CIRCUITCTRATING]	The circuit CT rating
[CIRCUITCURRENTRATING]	The circuit current rating
[CIRCUITNAME]	The circuit name
[CIRCUITPOLE]	The circuit power line identifier

Placeholder	Definition
[CIRCUITSENSOR]	The circuit sensor name
[CIRCUIT]	The circuit identifier
[CONFIGPARAM]	The name of a configuration parameter
[CONFIGVALUE]	The new value of a parameter
[DATETIME]	The human readable timestamp of the event occurrence
[DEVICEIP]	The IP address of the device, the event occurred on
[DEVICENAME]	The name of the device, the event occurred on
[ERRORDESC]	The error message
[EVENTRULENAME]	The name of the matching event rule
[EXTSENSORNAME]	The name of a peripheral device
[EXTSENSORSLOT]	The ID of a peripheral device slot
[EXTSENSOR]	The peripheral device identifier
[IFNAME]	The human readable name of a network interface
[INLETPOLE]	The inlet power line identifier
[INLETSENSOR]	The inlet sensor name
[INLET]	The power inlet label
[ISASSERTED]	Boolean flag whether an event condition was entered (1) or left (0)
[LDAPERRORDESC]	An LDAP error occurred
[LHXFANID]	The ID of a fan connected to an LHX/SHX
[LHXPOWERSUPPLYID]	The ID of an LHX/SHX power supply
[LHXSENSORID]	The ID of an LHX/SHX sensor probe
[MONITOREDHOST]	The name or IP address of a monitored host
[OCPSENSOR]	The overcurrent protector sensor name
[OCP]	The overcurrent protector label
[OLDVERSION]	The firmware version the device is being upgraded from

Placeholder	Definition
[OUTLETNAME]	The outlet name <hr/> <i>Note: If any outlet does not have a name, neither an outlet name nor an outlet number will be shown in the custom message for it. Therefore, it is recommended to check the availability of all outlet names if intending to use this placeholder.</i> <hr/>
[OUTLETPOLE]	The outlet power line identifier
[OUTLETSENSOR]	The outlet sensor name
[OUTLET]	The outlet label
[PDUPOLESENSOR]	The sensor name for a certain power line
[PDUSENSOR]	The PDU sensor name
[PERIPHDEVPOSITION]	The position of an attached peripheral device
[PHONENUMBER]	The phone number an SMS was sent to
[PORTID]	The label of the external port, the event triggering device is connected to
[PORTTYPE]	The type of the external port (for example, 'feature' or 'auxiliary'), the event triggering device is connected to
[POWERMETERPOLE]	The PMC power meter line identifier
[POWERMETERSENSOR]	The PMC power meter sensor name
[POWERMETER]	The PMC power meter ID
[RADIUSERRORDESC]	A Radius error occurred
[ROMCODE]	The rom code of an attached peripheral device
[SENSORREADINGUNIT]	The unit of a sensor reading
[SENSORREADING]	The value of a sensor reading
[SENSORREPORT]	The formatted sensor report contents
[SENSORSTATENAME]	The human readable state of a sensor
[SMTPRECIPIENTS]	The list of recipients, an SMTP message was sent to
[SMTPSERVER]	The name or IP address of an SMTP server
[SYSCONTACT]	SysContact as configured for SNMP
[SYSLOCATION]	SysLocation as configured for SNMP

Placeholder	Definition
[SYSNAME]	SysName as configured for SNMP
[TIMEREVENTID]	The id of a timer event
[TIMESTAMP]	The timestamp of the event occurrence
[TRANSFERSWITCHREASON]	The transfer reason
[TRANSFERSWITCHSENSOR]	The transfer switch sensor name
[TRANSFERSWITCH]	The transfer switch label
[UMTARGETROLE]	The name of a user management role, an action was applied on
[UMTARGETUSER]	The user, an action was triggered for
[USERIP]	The IP address, a user connected from
[USERNAME]	The user who triggered an action
[VERSION]	The firmware version the device is upgrading to

Editing or Deleting a Rule/Action

You can change the settings of an event rule, action or scheduled action, or delete them.

*Exception: Some settings of the built-in event rules or actions are not user-configurable. Besides, you cannot delete built-in rules and actions. See **Built-in Rules and Rule Configuration** (on page 273) or **Available Actions** (on page 289).*

► To edit or delete an event rule, action or scheduled action:

1. Choose Device Settings > Event Rules.
2. Click the desired one in the list of rules, actions or scheduled actions. Its setup page opens.
3. Perform the desired action.
 - To modify settings, make necessary changes and then click Save.
 - To delete it, click  **Delete** on the top-right corner. Then click Delete on the confirmation message.

Sample Event Rules

Sample PDU-Level Event Rule

In this example, we want the PX3 to record the firmware upgrade failure in the internal log when it happens.

The event rule involves:

- Event: Device > Firmware update failed
- Action: System Event Log Action

▶ To create this PDU-level event rule:

1. For an event at the PDU level, select "Device" in the Event field.
2. Select "Firmware update failed" so that the PX3 responds to the event related to firmware upgrade failure.
3. To make the PX3 record the firmware update failure event in the internal log, select "System Event Log Action" in the Available Actions field.

Sample Outlet-Level Event Rule

In this example, we want the PX3 to send SNMP notifications to the SNMP manager for any sensor change event of outlet 3.

The event rule involves:

- Event: Outlet > Outlet 3 > Sensor > Any sub-event
- Action: System SNMP Notification Action

▶ To create this outlet-level event rule:

1. For an event at the outlet level, select "Outlet" in the Event field.
2. Select "Outlet 3" because that is the desired outlet.
3. Select "Sensor" to refer to sensor-related events.
4. Select "Any sub-event" to include all events related to all sensors of this outlet and all thresholds, such as current, voltage, upper critical threshold, upper warning threshold, lower critical threshold, lower warning threshold, and so on.
5. To make the PX3 send SNMP notifications, select "System SNMP Notification Action" in the Available Actions field.

*Note: The SNMP notifications may be SNMP v2c or SNMP v3 traps/informs, depending on the settings for the System SNMP Notification Action. See **Enabling and Configuring SNMP** (on page 357).*

Then the SNMP notifications are sent when:

- Any numeric sensor's reading enters the warning or critical range.

- Any sensor reading or state returns to normal.
- Any sensor becomes unavailable.
- The active energy sensor is reset.
- Any state sensor changes its state.

For example, when the outlet 3's voltage exceeds the upper warning threshold, the SNMP notifications are sent, and when the voltage drops below the upper warning threshold, the SNMP notifications are sent again.

Sample Inlet-Level Event Rule

In this example, we want the PX3 to send SNMP notifications to the SNMP manager for any sensor change event of the Inlet I1.

The event rule involves:

- Event: Inlet > Sensor > Any sub-event
- Action: System SNMP Notification Action

► **To create the above event rule:**

1. For an event at the inlet level, select "Inlet" in the Event field.
2. Select "Sensor" to refer to sensor-related events.
3. Select "Any sub-event" to include all events related to all sensors of this inlet and all thresholds, such as current, voltage, upper critical threshold, upper warning threshold, lower critical threshold, lower warning threshold, and so on.
4. To make the PX3 send SNMP notifications, select "System SNMP Notification Action" in the Available Actions box.

*Note: The SNMP notifications may be SNMP v2c or SNMP v3 traps/informs, depending on the settings for the System SNMP Notification Action. See **Enabling and Configuring SNMP** (on page 357).*

Then the SNMP notifications are sent when:

- Any numeric sensor's reading enters the warning or critical range.
- Any sensor reading or state returns to normal.
- Any sensor becomes unavailable.
- The active energy sensor is reset.

For example, when the Inlet I1's voltage exceeds the upper warning threshold, the SNMP notifications are sent, and when the voltage drops below the upper warning threshold, the SNMP notifications are sent again.

Sample Environmental-Sensor-Level Event Rule

This section applies to outlet-switching capable models only.

In this example, we want PX3 to activate the load shedding function when a contact closure sensor enters the alarmed state. This event rule requires creating a new action before creating the rule.

► **Step 1: create a new action for activating the load shedding**

1. Choose Device Settings > Event Rules > **+ New Action**.
2. In this illustration, assign the name "Activate Load Shedding" to the new action.
3. In the Action field, select "Change load shedding state."
4. In the Operation field, select Start Load Shedding.
5. Click Create to finish the creation.

After the new action is created, follow the procedure below to create an event rule that triggers the load shedding mode when the contact closure sensor enters the alarmed state. This event rule involves the following:

- Event: Peripheral Device Slot > Slot 1 > State Sensor/Actuator > Alarmed/Open/On
- Trigger condition: Alarmed
- Action: Activate Load Shedding

► **Step 2: create the contact closure-triggered load shedding event rule**

1. Click **+ New Rule** on the Event Rules page.
2. In this illustration, assign the name "Contact Closure Triggered Load Shedding" to the new rule.
3. In the Event field, select "Peripheral Device Slot" to indicate we are specifying an event related to the environmental sensor package.
4. Select the ID number of the desired contact closure sensor. In this illustration, the ID number of the desired contact closure sensor is 1, so select Slot 1.

*Note: ID numbers of all sensors/actuators are available on the Peripherals page. See **Peripherals** (on page 175).*

5. Select "State Sensor/Actuator" because the contact closure sensor is a state sensor.

6. Select "Alarmed" since we want the PX3 to respond when the selected contact closure sensor changes its state related to the "alarmed" state.
7. In the "Trigger condition" field, select the Alarmed/Open/On radio button so that the action is taken only when the contact closure sensor enters the alarmed state.
8. Select "Activate Load Shedding" from the Available Actions list.

A Note about Infinite Loop

You should avoid building an infinite loop when creating event rules. The infinite loop refers to a condition where the PX3 keeps busy because the action or one of the actions taken for a certain event triggers an identical or similar event which will result in an action triggering one more event.

Example 1

This example illustrates an event rule which continuously causes the PX3 to send out email messages.

Event selected	Action included
Device > Sending SMTP message failed	Send email

Example 2

This example illustrates an event rule which continuously causes the PX3 to send out SMTP messages when one of the selected events listed on the Device menu occurs. Note that <Any sub-event> under the Device menu includes the event "Sending SMTP message failed."

Event selected	Action included
Device > Any sub-event	Send email

Example 3

This example illustrates a situation where two event rules combined regarding the outlet state changes causes the PX3 to continuously power cycle outlets 1 and 2 in turn.

Event selected	Action included
Outlet > Outlet 1 > Sensor > Outlet State > On/Off > Both (trigger condition)	Cycle Outlet 2 (Switch outlets --> Cycle Outlet --> Outlet 2)

Event selected	Action included
Outlet > Outlet 2 > Sensor > Outlet State > On/Off > Both (trigger condition)	Cycle Outlet 1 (Switch outlets --> Cycle Outlet --> Outlet 1)

A Note about Untriggered Rules

In some cases, a measurement exceeds a threshold causing the PX3 to generate an alert. The measurement then returns to a value within the threshold, but the PX3 does not generate an alert message for the Deassertion event. Such scenarios can occur due to the hysteresis tracking the PX3 uses. See *"To De-assert" and Deassertion Hysteresis* (on page 680).

Setting Data Logging

The PX3 can store 120 measurements for each sensor in a memory buffer. This memory buffer is known as the data log. Sensor readings in the data log can be retrieved using SNMP.

You can configure how often measurements are written into the data log using the Measurements Per Log Entry field. Since the PX3 internal sensors are measured every second, specifying a value of 60, for example, would cause measurements to be written to the data log once every minute. Since there are 120 measurements of storage per sensor, specifying a value of 60 means the log can store the last two hours of measurements before the oldest one in the log gets overwritten.

Whenever measurements are written to the log, three values for each sensor are written: the average, minimum and maximum values. For example, if measurements are written every minute, the average of all measurements that occurred during the preceding 60 seconds along with the minimum and maximum measurement values are written to the log.

*Note: The PX3 device's SNMP agent must be enabled for this feature to work. See **Enabling and Configuring SNMP** (on page 357). In addition, using an NTP time server ensures accurately time-stamped measurements.*

By default, data logging is enabled. You must have the "Administrator Privileges" or "Change Pdu, Inlet, Outlet & Overcurrent Protector Configuration" permissions to change the setting.

► **To configure the data logging feature:**

1. Choose Device Settings > Data Logging.

2. To enable the data logging feature, select the "Enable" checkbox in the General Settings section.
3. Type a number in the Measurements Per Log Entry field. Valid range is from 1 to 600. The default is 60.
4. Verify that all sensor logging is enabled. If not, click Enable All at the bottom of the page to have all sensors selected.
 - You can also click the topmost checkbox labeled "Logging Enabled" in the header row of each section to select all sensors of the same type.
 - If any section's number of sensors exceeds 35, the remaining sensors are listed on next page(s). If so, a pagination bar similar to the following diagram displays in this section, which you can click any button to switch between pages.



5. Click Save. This button is located at the bottom of the page.

Important: Although it is possible to selectively enable/disable logging for individual sensors on the PX3, it is NOT recommended to do so.

Configuring Data Push Settings

You can push the sensor or asset strip data to a remote server for data synchronization. The data will be sent in JSON format using HTTP POST requests. You need to set up the destination and authentication for data push on the PX3.



For instructions on connecting asset strips, see *Connecting Asset Management Strips* (on page 72).

After configuring the destination and authentication settings, do either or both of the following:

- To perform the data push after the occurrence of a certain event, create the data push action and assign it to an event rule.
- To push the data at a regular interval, schedule the data push action. See *Event Rules and Actions* (on page 272).

► **To configure data push settings:**

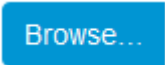
1. Choose Device Settings > Data Push.
2. To specify a destination, click **+ New Destination**.
3. Do the following to set up the URL field.
 - a. Click  to select *http* or *https*.

- b. Type the URL or host name in the accompanying text box.
 4. If selecting https, a CA certificate is required for making the connection. Click  to install it. Then you can:
 - Click Show to view the certificate's content.
 - Click Remove to delete the installed certificate if it is inappropriate.
 5. If the destination server requires authentication, select the Use Authentication checkbox, and enter the following data.
 - User name
 - Password
 6. In the Entry Type field, determine the data that will be transmitted.
 - Asset management tag list: Transmit the information of the specified asset strip(s), including the general status of the specified strip(s) and a list of asset tags. The asset tags list also includes those on blade extension strips, if any.
 - Asset management log: Transmit the log of all asset strips, which is generated when there are changes made to asset tags and asset strips, including asset tag connection or disconnection events.
 - Sensor log: Transmit the record of all logged sensors, including their sensor readings and/or status. Logged sensors refer to all internal and/or environmental sensors/actuators that you have selected on the Data Logging page. See *Setting Data Logging* (on page 317).
 7. If "Asset management tag list" is selected in the above step, specify the asset strip(s) whose information to send. For PX3 with only one FEATURE port, only one asset strip is available.
 - To specify the asset strip(s), select them one by one from the Available AMS Ports list. Or click Select All to add all.
 - To remove the asset strip(s), click that asset strip's  in the Selected AMS Ports field. Or click Deselect All to remove all.
 8. Click Create.
 9. Repeat the same steps for additional destinations.
- ▶ **To modify or delete data push settings:**
1. On the Data Push page, click the one you want in the list.
 2. Perform either action below.
 - To modify settings, make necessary changes and then click Save.
 - To delete it, click , and then confirm it on the confirmation message.

Monitoring Server Accessibility

You can monitor whether specific IT devices are alive by having the PX3 device continuously ping them. An IT device's successful response to the ping commands indicates that the IT device is still alive and can be remotely accessed.

This function is especially useful when you are not located in an area with Internet connectivity.

PX3 can monitor the accessibility of any IT device, such as database servers, remote authentication servers, power distribution units (PDUs), and so on. It supports monitoring a maximum of 8 devices.

The default ping settings may not be suitable for monitoring devices that require high connection reliability so it is strongly recommended that you should adjust the ping settings for optimal results.

*Tip: To make the PX3 automatically log, send notifications or perform other actions for any server monitoring events, you can create event rules. See **Event Rules and Actions** (on page 272). An example is available in **Example: Ping Monitoring and SNMP Notifications** (on page 322).*

► **To add IT equipment for ping monitoring:**

1. Choose Device Settings > Server Reachability.
2. Click **+ Monitor New Server**.
3. By default, the "Enable ping monitoring for this server" checkbox is selected. If not, select it to enable this feature.
4. Configure the following.

Field	Description
IP address/hostname	IP address or host name of the IT equipment which you want to monitor.
Number of successful pings to enable feature	The number of successful pings required to declare that the monitored equipment is "Reachable." Valid range is 0 to 200.
Wait time after successful ping	The wait time before sending the next ping if the previous ping was successfully responded. Valid range is 5 to 600 (seconds).
Wait time after unsuccessful ping	The wait time before sending the next ping if the previous ping was not responded. Valid range is 3 to 600 (seconds).

Field	Description
Number of consecutive unsuccessful pings for failure	The number of consecutive pings without any response before the monitored equipment is declared "Unreachable." Valid range is 1 to 100.
Wait time before resuming pinging after failure	The wait time before the PX3 resumes pinging after the monitored equipment is declared "Unreachable." Valid range is 1 to 1200 (seconds).
Number of consecutive failures before disabling feature (0 = unlimited)	The number of times the monitored equipment is declared "Unreachable" consecutively before the PX3 disables the ping monitoring feature for it and shows "Waiting for reliable connection." Valid range is 0 to 100.

5. Click Create.
6. To add more IT devices, repeat the same steps.

In the beginning, the status of the added IT equipment shows "Waiting for reliable connection," which means the requested number of consecutive successful or unsuccessful pings has not reached before the PX3 can declare that the monitored device is reachable or unreachable.

► **To check the server monitoring states and results:**

1. After adding IT equipment for monitoring, all IT devices are listed on the Server Reachability page.
2. The column labeled "Ping Enabled" indicates whether the monitoring for the corresponding IT device is activated or not.
3. The column labeled "Status" indicates the accessibility of each monitored equipment.

Status	Description
Reachable	The monitored equipment is accessible.
Unreachable	The monitored equipment is inaccessible.
Waiting for reliable connection	The connection between the PX3 device and the monitored equipment is not reliably established yet.

Editing or Deleting Ping Monitoring Settings

You can edit the ping monitoring settings of any IT device or simply delete it if no longer needed.

► **To modify or delete any monitored IT device:**

1. Choose Device Settings > Server Reachability.
2. Click the desired one in the list.
3. Perform the desired action.
 - To modify settings, make necessary changes and then click Save. For information on each field, see *Monitoring Server Accessibility* (on page 320).
 - To delete it, click  on the top-right corner.

Example: Ping Monitoring and SNMP Notifications

In this illustration, it is assumed that a significant PDU (IP address: 192.168.84.95) shall be monitored by your PX3 to make sure that PDU is properly operating all the time, and the PX3 must send out SNMP notifications (trap or inform) if that PDU is declared unreachable due to power or network failure. The prerequisite for this example is that the power sources are different between your PX3 and the monitored PDU.

This requires the following two steps.

► **Step 1: Set up the ping monitoring for the target PDU**

1. Choose Device Settings > Server Reachability.
2. Click  **Monitor New Server**.
3. Ensure the "Enable ping monitoring for this server" checkbox is selected.
4. Enter the data shown below.
 - Enter the server's data.

Field	Data entered
IP address/hostname	192.168.84.95

- To make the PX3 declare the accessibility of the monitored PDU every 15 seconds (3 pings * 5 seconds) when that PDU is accessible, enter the following data.

Field	Data entered
Number of successful pings to enable feature	3

Field	Data entered
Wait time after successful ping	5

- To make the PX3 declare the inaccessibility of the monitored PDU when that PDU becomes inaccessible for around 12 seconds (4 seconds * 3 pings), enter the following data.

Field	Data entered
Wait time after unsuccessful ping	4
Number of consecutive unsuccessful pings for failure	3

- To make the PX3 stop pinging the target PDU for 60 seconds (1 minute) after the PDU inaccessibility is declared. After 60 seconds, the PX3 will re-ping the target PDU, enter the following data.

Field	Data entered
Wait time before resuming pinging after failure	60

- The "Number of consecutive failures before disabling feature (0 = unlimited)" can be set to any value you want.

5. Click Create.

► **Step 2: Create an event rule to send SNMP notifications for the target PDU**

- Choose Device Settings > Event Rules.
- Click **+ New Rule**.
- Select the Enabled checkbox to enable this new rule.
- Configure the following.

Field/setting	Data specified
Rule name	Send SNMP notifications for PDU (192.168.84.95) inaccessibility
Event	Choose Server Monitoring > 192.168.84.95 > Unreachable
Trigger condition	Select the Unreachable radio button

This will make the PX3 react only when the target PDU becomes inaccessible.

5. Select the System SNMP Notification Action.

*Note: If you have not configured the System SNMP Notification Action to specify the SNMP destination(s), see **Editing or Deleting a Rule/Action** (on page 312).*

Front Panel Settings

You can set up the default mode of the front panel display, and front panel functions for outlet switching, actuator control, or RCM self-test.

Note that available front panel settings are model dependent.

- Outlet switching -- available on outlet-switching capable models only.
- Actuator control -- available on all models.
- Default front panel mode setup -- available on all models, except for the PX3-3000 series, which does NOT provide inlet sensor information.
- RCM self-test -- available on those models which support residual current monitoring. See **PX3 Models with Residual Current Monitoring** (on page 588).

► **To configure the front panel settings:**

1. Choose Device Settings > Front Panel.
2. Configure the following:
 - To configure the default view of the LCD display, select one mode below.

*Note: The default view is shown in the automatic mode. See **Automatic and Manual Modes** (on page 93).*

Mode	Data entered
Automatic mode	The LCD display cycles through both the inlet and overcurrent protector information. This is the default. Overcurrent protector information is available only when you PX3 has overcurrent protectors.
Inlet overview	The LCD display cycles through the inlet information only.

- To enable the front panel outlet-switching function, select the "Outlet switching" checkbox.

- To enable the front panel actuator-control function, select the "Peripheral actuator control" checkbox.
 - By default the front panel RCM self-test function, if available, is enabled. See *Disabling or Enabling Front Panel RCM Self-Test* (on page 593).
3. Now you can turn on or off outlets/actuators by operating the front panel. See Power Control and *Peripherals* (on page 104).

Configuring the Serial Port

You can change the bit rate of the serial port labeled CONSOLE / MODEM on the PX3. The default bit rate for both console and modem operation is 115200 bps.

The PX3 supports using the following devices via the serial interface:

- A computer or Raritan KVM product for console management.
- An analog modem for remote dial-in and access to the CLI.
- A GSM modem for sending out SMS messages to a cellular phone.

Bit-rate adjustment may be necessary. Change the bit rate before connecting the supported device to the PX3 through the serial port, or there are communication problems.

Note: The serial port bit-rate change is required when the PX3 works in conjunction with Raritan's Dominion LX KVM switch. Dominion LX only supports 19200 bps for communications over the serial interface.

You can set diverse bit-rate settings for console and modem operations. Usually the PX3 can detect the device type, and automatically apply the preset bit rate.

The PX3 will indicate the detected device in the Port State section of the Serial Port page. For example, if an analog modem is detected, the Port State section looks similar to the following.

To configure serial port or modem settings, choose Device Settings > Serial Port.

► **To change the serial port baud rate settings:**

1. Click the "Connected device" field to make the serial port enter an appropriate state.

Options	Description
Automatic detection	The PX3 automatically detects the type of the device connected to the serial port. Select this option unless your PX3 cannot correctly detect the device type.

Options	Description
Force console	The PX3 attempts to recognize that the connected device is set for the console mode.
Force analog modem	The PX3 attempts to recognize that the connected device is an analog modem.
Force GSM modem	The PX3 attempts to recognize that the connected device is a GSM modem.

- Click the Console Baud Rate field to select the baud rate intended for console management.

Note: For a serial RS-232 or USB connection between a computer and the PX3, leave it at the default (115200 bps).

- Click the Modem Baud Rate field to select the baud rate for the modem connected to the PX3.

The following modem settings/fields appear in the web interface after the PX3 detects the connection of an analog or GSM modem.

► **To configure the analog modem:**

- Select the "Answer incoming calls" checkbox to enable the remote access via a modem. Otherwise, deselect it.
- Type a value in the "Number of rings before answering" field to determine the number of rings the PX3 must wait before answering the call.

► **To configure the GSM modem:**

- Enter the SIM PIN code.
- Select the "Use custom SMS center number" checkbox if a custom SMS center will be used.
 - Enter the SMS center number in the "SMS center" field.
- If needed, click Advanced Information to view detailed information about the modem, SIM and mobile network.
- To test whether the PX3 can successfully send out SMS messages with the modem settings:
 - Enter the number of the recipient's phone in the Recipient Phone field.
 - Click Send SMS Test to send a test SMS message.

Lua Scripts

If you can write or obtain any Lua scripts, you can create or load them into the PX3 to control its behaviors.

Raritan also provides some Lua scripts examples, which you can load as needed.

Note: Not all Raritan Lua script examples can apply to your PX3 model. You should read each example's introduction before applying them.

You must have the Administrator Privileges to manage Lua scripts.

Writing or Loading a Lua Script

You can enter or load up to 4 scripts to the PX3.

*Tip: If you can no longer enter or load a new script after reaching the upper limit, you can either delete any existing script or simply modify/replace an existing script's codes. See **Modifying or Deleting a Script** (on page 331).*

► To write or load a Lua script:

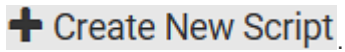
1. Choose Device Settings > Lua Scripts > .
2. Type a name for this script. Its length ranges between 1 to 63 characters.

The name must contain the following characters only.

- Alphanumeric characters
- Underscore (_)
- Minus (-)

Note: Spaces are NOT permitted.

3. Determine whether and when to automatically execute the loaded script.

Checkbox	Behavior when selected
Start automatically at system boot	Whenever the PX3 reboots, the script is automatically executed.
Restart after termination	The script is automatically executed each time after 10 seconds since the script execution finishes.

4. (Optional) Determine the arguments that will be executed by default.

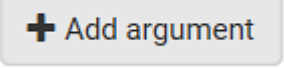
- a. Click .

- b. Type the key and value.
- c. Repeat the same steps to enter more arguments as needed.
 - To remove any existing argument, click  adjacent to it.

*Note: Default arguments are overridden by the new arguments specified with the "Start with Arguments" command or with any Lua-script-related event rule. See **Manually Starting or Stopping a Script** (on page 329) or **Start or Stop a Lua Script** (on page 302).*

5. In the Source Code section, do one of the following. It is recommended to leave the Enable Syntax Highlighting checkbox selected unless you do not need different text colors to identify diverse code syntaxes.
 - To write a Lua script, type the codes in the Source Code section.

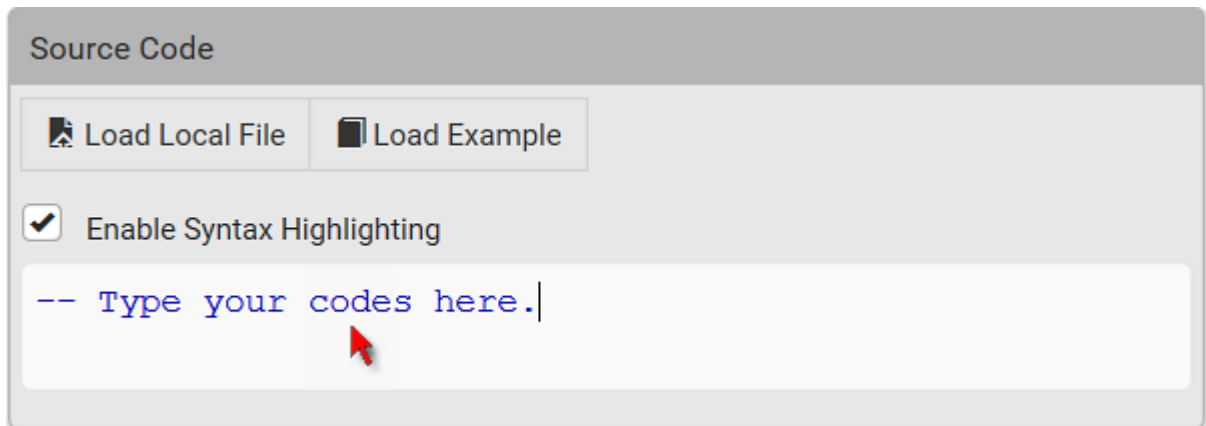



- To load an existing Lua script file, click Load Local File.
- To use one of Raritan's Lua script examples, click Load Example.

Warning: The newly-loaded script will overwrite all existing codes in the Source Code section. Therefore, do not load a new script if the current script meets your needs.

6. If you chose to load a script or Raritan's example in the previous step, its codes are then displayed in the Source Code section. Double check the codes. If needed, modify the codes to meet your needs.
7. Click Create.

▶ **Next steps:**

- To execute the newly-added script now, click  **Start**, or click  > Start with Arguments. See *Manually Starting or Stopping a Script* (on page 329).
- To add more scripts, return to the scripts list by clicking "Lua Scripts" again in the *Menu* (on page 132), and then repeat the above steps.

Manually Starting or Stopping a Script

You can manually start or stop an existing Lua script at any time.



When starting a script, you can choose to start it either with its default arguments or with new arguments.

*Tip: To have the PX3 automatically start or stop a script in response to an event, create an event rule. See **Event Rules and Actions** (on page 272) and **Start or Stop a Lua Script** (on page 302).*

▶ **To manually start a script:**

1. Choose Device Settings > Lua Scripts. The Lua scripts list displays.

Lua Scripts			 Create New Script
Name	State	Autostart	Restart
script-1	Terminated	yes	no
script-2	New	no	yes
script-3	Running	no	no

2. Click the desired script whose state is either 'Terminated' or 'New.' For details, see *Checking Lua Scripts States* (on page 331).
3. To start with default arguments, click  **Start**.
To start with new arguments, click  > Start with Arguments. Newly-assigned arguments will override default ones.
4. If you chose "Start with Arguments" in the above step, enter the key and value in the Start Lua Script dialog.

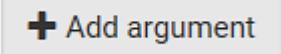
- Click  if needing additional arguments.

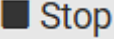

The image shows a dialog box titled "Start Lua Script". It has a header section with the title. Below the header, there are two columns: "Key" and "Value". Each column has a text input field. To the right of the "Value" input field is a minus sign button (-). Below the input fields is a button labeled "+ Add Argument". At the bottom right of the dialog box are two buttons: "Cancel" and "Start".

5. Click Start.
 6. The script output will be shown in the Script Output section.
 - If needed, click  to delete the existing output data.
- **To manually stop a script:**
1. Choose Device Settings > Lua Scripts.
 2. Click the desired script whose state is either 'Running' or 'Restarting.' For details, see *Checking Lua Scripts States* (on page 331).
 3. Click  on the top-right corner.
 4. Click Stop on the confirmation message.

Checking Lua Scripts States

Choose Device Settings > Lua Scripts to show the scripts list, which indicates the current state and settings of each script.

Lua Scripts				+ Create New Script
Name	State	Autostart	Restart	
script-1	Terminated	yes	no	
script-2	New	no	yes	
script-3	Running	no	no	

► State:

Four script states are available.

- *New*: The script is never executed since the device boot.
- *Running*: The script is currently being executed.
- *Terminated*: The script was once executed, but stops now.
- *Restarting*: The script will be executed. Only the scripts with the "Restart" column set to "yes" will show this state.

► Autostart:

This column indicates whether the checkbox labeled "Start automatically at system boot" is enabled. See *Writing or Loading a Lua Script* (on page 327).

► Restart:

This column indicates whether the checkbox labeled "Restart after termination" is enabled. See *Writing or Loading a Lua Script* (on page 327).

Modifying or Deleting a Script

You can edit an existing script's codes or even replace it with a new script. Or you can simply remove a unnecessary script from the PX3.

► To modify or replace a script:

1. Choose Device Settings > Lua Scripts.
2. Click the desired one in the scripts list.

3. Click  > Edit Script.
4. Make changes to the information shown, except for the script's name, which cannot be revised.
 - To replace the current script, click Load Local File or Load Example to select a new script.

► **To delete a script:**

1. Choose Device Settings > Lua Scripts.
2. Click the desired one in the scripts list.
3. Click  > Delete.
4. Click Delete on the confirmation message.

Miscellaneous

By default, the Schroff LHX/SHX heat exchanger support and Cisco EnergyWise feature implemented on the PX3 are disabled.

Support needs to be enabled for the LHX/SHX information to appear in the PX3 web interface. Besides, Schroff LHX/SHX support must be enabled in order for the LHX-MIB to be accessible through SNMP.

If a Cisco® EnergyWise energy management architecture is implemented in your place, you can enable the Cisco EnergyWise endpoint implemented on the PX3 so that this PX3 becomes part of the Cisco EnergyWise domain.

To enable either feature, choose Device Settings > Miscellaneous.

► **To enable the support for Schroff LHX/SHX:**

1. Select the Schroff LHX/SHX Support checkbox.
2. Click Save in the *Features* section.
3. Click Apply on the confirmation message.
4. The PX3 reboots.

► **To set the Cisco EnergyWise configuration:**

1. Select the Enable EnergyWise checkbox.
2. Configure the following:

Field	Description
Domain name	Type the name of a Cisco EnergyWise domain where the PX3 belongs <ul style="list-style-type: none"> ▪ Up to 127 printable ASCII characters are permitted. ▪ Spaces and asterisks are NOT acceptable.

Field	Description
Domain password	Type the authentication password (secret) for entering the Cisco EnergyWise domain <ul style="list-style-type: none"> Up to 127 printable ASCII characters are permitted. Spaces and asterisks are NOT acceptable.
Port	Type a User Datagram Protocol (UDP) port number for communications in the Cisco EnergyWise domain. <ul style="list-style-type: none"> Range from 1 to 65535. Default is 43440.
Polling interval	Type a polling interval to determine how often the PX3 is queried in the Cisco EnergyWise domain. <ul style="list-style-type: none"> Range from 30 to 600 ms. Default is 180 ms.

- Click Save in the *EnergyWise* section.

Maintenance

Click 'Maintenance' in the **Menu** (on page 132), and the following submenu displays.

Submenu command	Refer to...
Device Information	<i>Device Information</i> (on page 334)
Connected Users	<i>Viewing Connected Users</i> (on page 338)
Event Log	<i>Viewing or Clearing the Local Event Log</i> (on page 339)
Update Firmware	<i>Updating the PX3 Firmware</i> (on page 341)
Firmware History	<i>Viewing Firmware Update History</i> (on page 343)
Bulk Configuration	<i>Bulk Configuration</i> (on page 344)
Backup/Restore	<i>Backup and Restore of Device Settings</i> (on page 347)
Network Diagnostic	<i>Network Diagnostics</i> (on page 348)
Download Diagnostic	<i>Downloading Diagnostic Information</i> (on page 349)
Unit Reset	<ul style="list-style-type: none"> <i>Rebooting the PX3 Device</i> (on page 350) <i>Resetting All Settings to Factory Defaults</i> (on page 350)
About iPDU	<i>Retrieving Software Packages Information</i> (on page 351)

Device Information

Using the web interface, you can retrieve hardware and software information of components or peripheral devices connected to your PX3.

Tip: If the information shown on this page does not match the latest status, press F5 to reload it.

► **To display device information:**

1. Choose Maintenance > Device Information.
2. Click the desired section's title bar to show that section's information. For example, click the Network section.



The number of available sections is model dependent.

Section title	Information shown
Information	General device information, such as model name, serial number, firmware version, hardware revision, MIB download link(s) and so on. Note that the download link of LHX-MIB is available only after enabling the Schroff LHX/SHX support. See <i>Miscellaneous</i> (on page 332).
Network	The network information, such as the current networking mode, IPv4 and/or IPv6 addresses and so on. This tab also indicates whether the PX3 is part of a cascading configuration. See <i>Identifying Cascaded Devices</i> (on page 335).
Port Forwarding	If the port forwarding mode is activated, this section will show a list of port numbers for all cascaded devices.
Outlets	Each outlet's receptacle type, operating voltage and rated current.
Overcurrent Protectors	Each overcurrent protector's type, rated current and the outlets that it protects.

Section title	Information shown
Controllers	Each inlet or outlet controller's serial number, board ID, firmware version and hardware version.
Inlets	Each inlet's plug type, rated voltage and current.
Peripheral Devices	Serial numbers, model names, position and firmware-related information of connected environmental sensor packages.
Asset Management	Each asset strip's ID, boot version, application version and protocol version.

Identifying Cascaded Devices

For information on how to cascade PX3 devices, see *Cascading Multiple PX3 Devices for Sharing Ethernet Connectivity* (on page 38).

This section explains how to identify a cascaded device on the Device Information page.

Note: For more information on the USB-cascading configuration, see the Cascading Guide, which is available from Raritan website's **Support page** (<http://www.raritan.com/support/>).

► **To identify the USB-cascading status:**

1. Choose Maintenance > Device Information.
2. Click the Network title bar.



- If the information shown on this page does not match the latest status, press F5 to reload it.

► **Cascading information in the Bridging mode:**

- The Common section contains two read-only fields for indicating the cascading status. Note that the cascading position is NOT available in the bridging mode.

Fields	Description
Port Forwarding	Indicates the Port Forwarding is disabled. See <i>Setting the Cascading Mode</i> (on page 231).
BRIDGE section	Indicates the device is in the bridging mode and its IP address.

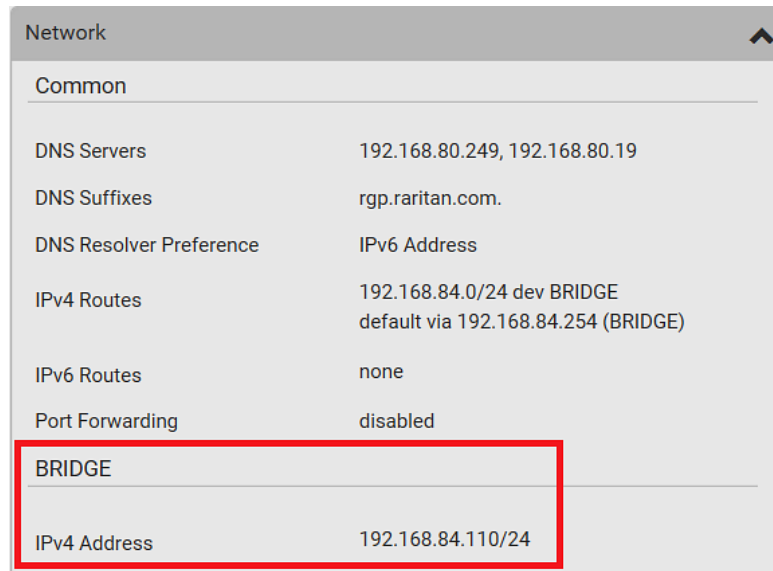

► **Cascading information in the Port Forwarding mode:**

- The Common section contains three read-only fields for indicating the cascading status.

Fields	Description
Port Forwarding	Indicates the Port Forwarding is enabled. See <i>Setting the Cascading Mode</i> (on page 231).
Cascade Position	Indicates the position of the PX3 in the cascading configuration. <ul style="list-style-type: none"> ▪ 0 (zero) represents the master device. ▪ A non-zero number represents a slave device. 1 is Slave 1, 2 is Slave 2, 3 is Slave 3 and so on.

Fields	Description
Cascaded Device Connected	Indicates whether a slave device is detected on the USB-A or Ethernet port. <ul style="list-style-type: none"> yes: Connection to a slave device is detected. no: NO connection to a slave device is detected.

- A master device shows 0 (zero) in the Cascade Position field and *yes* in the Cascaded Device Connected field.

The screenshot shows the 'Network' configuration page with a 'Common' section. The 'Cascade Position' field is highlighted with a red box and contains the value '0 (Master)'. The 'Cascaded Device Connected' field is also highlighted with a red box and contains the value 'yes'.

Network	
Common	
DNS Servers	192.168.80.249, 192.168.80.19
DNS Suffixes	rgp.raritan.com.
DNS Resolver Preference	IPv6 Address
IPv4 Routes	192.168.84.0/24 dev ETH1 default via 192.168.84.254 (ETH1)
IPv6 Routes	none
Port Forwarding	enabled
Cascade Position	0 (Master)
Cascaded Device Connected	yes

- A slave device in the middle position shows a non-zero number which indicates its exact position in the Cascade Position field and *yes* in the Cascaded Device Connected field.

The following diagram shows 1, indicating it is the first slave - Slave 1.

The screenshot shows the 'Network' configuration page with a 'Common' section. The 'Cascade Position' field is highlighted with a red box and contains the value '1 (Slave)'. The 'Cascaded Device Connected' field is also highlighted with a red box and contains the value 'yes'.

Network	
Common	
DNS Servers	192.168.80.249, 192.168.80.19
DNS Suffixes	rgp.raritan.com.
DNS Resolver Preference	IPv6 Address
Port Forwarding	enabled
Cascade Position	1 (Slave)
Cascaded Device Connected	yes

- The final slave device shows a non-zero number which indicates its position in the Cascade Position field and *no* in the Cascaded Device Connected field.

The following diagram shows 2, indicating it is the second slave - Slave 2. The Cascaded Device Connected field shows *no*, indicating that it is the final one in the chain.



- For a list of port numbers required for accessing each cascaded device in the port forwarding mode, click the Port Forwarding title bar on the same page.



Viewing Connected Users

You can check which users have logged in to the PX3 device and their status. If you have administrator privileges, you can terminate any user's connection to the PX3.

► **To view and manage connected users:**

1. Choose Maintenance > Connected Users. A list of logged-in users displays.

If wanted, you can resort the list by clicking the desired column header. See *Sorting a List* (on page 134).

Column	Description
User name	The login name of each connected user.
IP Address	The IP address of each user's host. For the login via a local connection (serial RS-232 or USB), <local> is displayed instead of an IP address.

Column	Description
Client Type	<p>The interface through which the user is being connected to the PX3.</p> <ul style="list-style-type: none"> ▪ Web GUI: Refers to the web interface. ▪ CLI: Refers to the command line interface (CLI). The information in parentheses following "CLI" indicates how this user is connected to the CLI. <ul style="list-style-type: none"> - Serial: The local connection, such as the serial RS-232 or USB connection. - SSH: The SSH connection. - Telnet: The Telnet connection. ▪ Webcam Live Preview: Refers to the live webcam image sessions. See below.
Idle Time	The length of time for which a user remains idle.

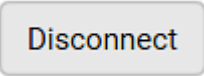

2. To disconnect any user, click the corresponding
 - a. Click Disconnect on the confirmation message.
 - b. The disconnected user is forced to log out.

► **If there are live webcam sessions:**

All Live Preview sessions sharing the same URL, including one Primary Standalone Live Preview window of the sender and two sessions of the remote recipients, are identified as one single "<webcam>" user in the Connected Users list. You can disconnect a "<webcam>" user to terminate all of the three sessions of a specific URL.

The IP address refers to the IP address of the host where the Primary Standalone Live Preview window exists, NOT the IP address of the other two associated sessions.

For more webcam information, see *Webcam Management* (on page 352).

Viewing or Clearing the Local Event Log

By default, the PX3 captures certain system events and saves them in a local (internal) event log.

You can view over 2000 historical events that occurred on the PX3 in the local event log. When the log size exceeds 256KB, each new entry overwrites the oldest one.

► **To display the local log:**

1. Choose Maintenance > Event Log.

Each event entry consists of:

- ID number of the event
- Date and time of the event
- Event type
- A description of the event

2. To view a specific type of events only, select the desired event type in the Filter Event Class field.

- To refresh the data, press F5 as needed.

3. To go to other pages of the log, click the pagination bar at the bottom of the page.

- If there are more than 5 pages and the page numbers displayed

in the bar does not show the desired one, click  to have it show the next or previous five page numbers, if available.



4. If wanted, you can resort the list by clicking the desired column header. See *Sorting a List* (on page 134).

► **To clear the local log:**

1. Click  on the top-right corner.
2. Click Clear Log on the confirmation message.

Updating the PX3 Firmware

Firmware files are available on Raritan website's *Support page* (<http://www.raritan.com/support/>).

When performing the firmware upgrade, the PX3 keeps each outlet's power status unchanged so no server operation is interrupted. During and after the firmware upgrade, outlets that have been powered on prior to the firmware upgrade remain powered on and outlets that have been powered off remain powered off.

You must be the administrator or a user with the Firmware Update permission to update the PX3 firmware.

Before starting the upgrade, read the release notes downloaded from the Raritan website's *Support page* (<http://www.raritan.com/support/>). If you have any questions or concerns about the upgrade, contact Raritan Technical Support BEFORE upgrading.

On a multi-inlet PDU (any model with X2 or X3 suffixes), all inlets must be connected to power for the PDU to successfully upgrade its firmware.

Note that firmware upgrade via some mobile devices, such as iPad, requires the use of a file manager app.

Warning: Do NOT perform the firmware upgrade over a wireless network connection.

Important: If you are upgrading an existing USB-cascading chain from a firmware version older than 3.3.10, you must follow specific guidelines to avoid networking issues. See *Upgrade Guidelines for Existing USB-Cascading Chains* (on page 342).

► To update the firmware:

1. Choose Maintenance > Update Firmware.
2. Click  to select an appropriate firmware file.
3. Click Upload. A progress bar appears to indicate the upload process.
4. Once complete, information of both installed and uploaded firmware versions as well as compatibility and signature-checking results are displayed.
 - If anything is incorrect, click Discard Upload.
5. To proceed with the update, click Update Firmware.

Warning: Do NOT power off the PX3 during the update.

6. During the firmware update:

- A progress bar appears on the web interface, indicating the update status.
 - The front panel display shows the firmware upgrade message. See *Showing the Firmware Upgrade Progress* (on page 117).
 - The outlet LEDs flash if the relay boards are being updated. If the firmware update does not include the update of the relay board firmware, outlet LEDs do NOT flash.
 - No users can successfully log in to the PX3.
 - Other users' operation, if any, is forced to suspend.
7. When the update is complete, the PX3 resets, and the Login page re-appears.
- Other logged-in users are logged out when the firmware update is complete.

Important: If you are using the PX3 with an SNMP manager, download its MIB again after the firmware update to ensure your SNMP manager has the correct MIB for the latest release you are using. See *Using SNMP* (on page 357).

► **Alternatives:**

To use a different method to update the firmware, refer to:

- *Firmware Update via SCP* (on page 535)
- *Bulk Configuration or Firmware Upgrade via DHCP/TFTP* (on page 562)
- *Firmware Upgrade via USB* (on page 560)

Upgrade Guidelines for Existing USB-Cascading Chains

- Firmware version 3.3.10 is NOT compatible with old firmware versions in terms of the USB-cascading feature so all devices in a chain must be running version 3.3.10 or later. Otherwise, a networking issue occurs.

Alternative: You can also choose to have an existing USB-cascading chain keep on running the old firmware without upgrading any device to 3.3.10 or later.

- When upgrading an existing USB-cascading chain from **any version prior to 3.3.10**, the upgrade must start from the last slave device, then the second to last, the third to last, and so on until the master device. Any upgrade without following this sequence results in the networking failure of some cascaded devices.

A Note about Firmware Upgrade Time

The PDU firmware upgrade time varies from unit to unit, depending on various external and internal factors.

External factors include, but are not limited to: network throughput, firmware file size, and speed at which the firmware is retrieved from the storage location. Internal factors include: the necessity of upgrading the firmware on the microcontroller and the number of microcontrollers that require upgrade (which depends on the number of outlets). The microcontroller is upgraded only when required. Therefore, the length of firmware upgrade time ranges from approximately 3 minutes (without any microcontroller updated) to almost 7 minutes (with all microcontrollers for 48 outlets updated). Take the above factors into account when estimating the PDU's firmware upgrade time.

The time indicated in this note is for PX3 web-interface-based upgrades. Upgrades through other management systems, such as Sunbird's Power IQ, may take additional time beyond the control of the PDU itself. This note does not address the upgrades using other management systems.

Full Disaster Recovery

If the firmware upgrade fails, causing the PX3 device to stop working, you can recover it by using a special utility rather than returning the device to Raritan.

Contact Raritan Technical Support for the recovery utility, which works in Windows XP/Vista/7/10 and Linux. In addition, an appropriate PX3 firmware file is required in the recovery procedure.

Note: All PX3 PDUs, except for iX7™ PDUs, can be recovered via either a USB or serial RS-232 connection. For iX7™, disaster recovery can be performed via the USB connection only.

Viewing Firmware Update History

The firmware upgrade history is permanently stored on the PX3. It remains available even though you perform a device reboot or any firmware update.

► To view the firmware update history:

1. Choose Maintenance > Firmware History.

Each firmware update event consists of:

- Update date and time
- Previous firmware version
- Update firmware version

- Update result
2. If wanted, you can resort the list by clicking the desired column header. See *Sorting a List* (on page 134).

Bulk Configuration

The Bulk Configuration feature lets you save generic settings of a configured PX3 device to your computer. You can use this configuration file to copy common settings to other PX3 devices of the same model and firmware version. See *Bulk Configuration Restrictions* (on page 345).

Note that **NO device-specific data is saved** to the bulk configuration file, such as environmental sensors or certain network settings. For a list of device-specific settings that are *not* saved, see *Device-Specific Settings NOT Included* (on page 346).

Because the date and time settings are saved in the configuration file, users should exercise caution when distributing the configuration file to the PX3 devices in a different time zone than the source device.

Tip: To back up or restore "all" settings of a particular PX3 device, use the Backup/Restore feature instead. See Backup and Restore of Device Settings (on page 347).

► To save a bulk configuration file:

You must have the Administrator Privileges or "Unrestricted View Privileges" to download the configuration.

1. Log in to the PX3 whose settings you want to copy.
2. Choose Maintenance > Bulk Configuration.
3. Click Download Bulk Configuration.
4. When prompted to open or save the configuration file, click Save.
 - The file is saved in the XML format, and its content is encrypted using the AES-128 encryption algorithm.

► To perform bulk configuration:

You must have the Administrator Privileges to upload the configuration.

1. Log in to another PX3 of the same model running the same firmware.
2. Choose Maintenance > Bulk Configuration.
3. Click  to select the configuration file.

4. Click 'Upload & Restore Bulk Configuration' to copy it.
5. A message appears, prompting you to confirm the operation and enter the admin password.
Enter the admin password, and click Restore.
6. Wait until the PX3 device resets and the login page re-appears.

Note: On startup, the PX3 performs all of its functions, including event rules and logs, based on the new configuration you have copied instead of the previous configuration prior to the device reset. For example, the "Bulk configuration copied" event is logged only when the new configuration file contains the "Bulk configuration copied" event rule.

► **The last configuration-copying record:**

If you once copied any bulk configuration or device backup file to the PX3, the last record similar to the following is displayed at the bottom of both the Bulk Configuration and Backup/Restore pages.

Last Restore: 2/24/2017, 6:05:53 PM, Status: OK

► **Alternatives:**

To use a different method to perform bulk configuration, refer to:

- **Bulk Configuration via SCP** (on page 536)
- **Bulk Configuration or Firmware Upgrade via DHCP/TFTP** (on page 562)
- **Configuration or Firmware Upgrade with a USB Drive** (on page 548)

Bulk Configuration Restrictions

A source device is the PX3 device where the bulk configuration file is downloaded/saved.

A target device is the PX3 device that loads this bulk configuration file.

► **Restrictions for bulk configuration:**

- The target device must be running the same firmware version as the source device.
- The target device must be of the same model type as the source device.
- Bulk configuration is permitted if the differences between the target and source devices are only "mechanical" designs which are indicated in a model name's suffix as listed below. In the following list, *n* represents a number.
 - PDU chassis color, which is indicated as *Kn*, such as K1 and K601

- Line cord color, which is indicated as Bn , such as B2 and B5
- Line cord length (meters), which is indicated as An , such as A0 and A14
- Line cord length (centimeters), which is indicated as Ln

► **Example:**

You can perform bulk configuration between Raritan's PX2-4724-E2N1K2 and PX2-4724-E2N1K9.

- Reason: The two models share the same technical specifications, and the only difference is their chassis colors represented by K2 (blue) and K9 (gray).

Device-Specific Settings NOT Included

The settings saved in the bulk configuration file include user and role configurations, thresholds, event rules, security settings, date/time and so on.

Note: Because the date and time settings are saved in the configuration file, users should exercise caution when distributing the configuration file to the PX3 devices in a different time zone than the source device.

The bulk configuration file does NOT contain device-specific information, including:

- Device name
- SNMP system name, contact and location
- Network settings (IP address, gateway, netmask and so on)
- Device logs
- Names, states and values of environmental sensors and actuators
- TLS certificate
- Server monitoring entries
- Asset strip names and rack unit names
- Outlet names and states

Backup and Restore of Device Settings

Unlike the bulk configuration file, the backup file contains ALL device settings, including device-specific data like device names and network settings. To back up or restore a PX3 device's settings, you should perform the Backup/Restore feature.

All PX3 information is captured in the XML backup file except for the device logs and TLS certificate.

*Note: To perform bulk configuration among multiple PX3 devices, use the Bulk Configuration feature instead. See **Bulk Configuration** (on page 344).*

► To download a backup PX3 XML file:

You must have the Administrator Privileges or "Unrestricted View Privileges" to download a backup file.

1. Choose Maintenance > Backup/Restore.
2. Click Download Device Settings. Save the file to your computer.
 - The file is saved in the XML format, and its content is encrypted using the AES-128 encryption algorithm.

► To restore the PX3 using a backup XML file:

You must have the Administrator Privileges to restore the device settings.

1. Choose Maintenance > Backup/Restore.
2. Click  to select the backup file.
3. Click 'Upload & Restore Device Settings' to upload the file.
 - A message appears, prompting you to confirm the operation and enter the admin password.
4. Enter the admin password, then click Restore.
5. Wait until the PX3 device resets and the Login page re-appears, indicating that the restore is complete.

Note: On startup, the PX3 performs all of its functions, including event rules and logs, based on the new configuration you have copied instead of the previous configuration prior to the device reset. For example, the "Bulk configuration copied" event is logged only when the new configuration file contains the "Bulk configuration copied" event rule.

► **The last configuration-copying record:**

If you once copied any bulk configuration or device backup file to the PX3, the last record similar to the following is displayed at the bottom of both the Bulk Configuration and Backup/Restore pages.

Last Restore: 2/24/2017, 6:05:53 PM, Status: OK

► **Alternative:**

To use a different method to perform backup/restore, refer to:

- **Backup and Restore via SCP** (on page 537)

Network Diagnostics

The PX3 provides the following tools in the web interface for diagnosing potential networking issues.

- **Ping:** The tool is useful for checking whether a host is accessible through the network or Internet.
- **Trace Route:** The tool lets you find out the route over the network between two hosts or systems.
- **List TCP Connections:** You can use this function to display a list of TCP connections.

*Tip: These network diagnostic tools are also available through CLI. See **Network Troubleshooting** (on page 530).*

Choose Maintenance > Network Diagnostics, and then perform any function below.

► **Ping:**

1. Type values in the following fields.

Field	Description
Network Host	The name or IP address of the host that you want to check.
Number of Requests	A number up to 20. This determines how many packets are sent for pinging the host.

- Click Run Ping to ping the host. The Ping results are then displayed.

► **Trace Route:**

- Type values in the following fields.

Field/setting	Description
Host Name	The IP address or name of the host whose route you want to check.
Timeout(s)	A timeout value in seconds to end the trace route operation.
Use ICMP Packets	To use the Internet Control Message Protocol (ICMP) packets to perform the trace route command, select this checkbox.

- Click Run. The Trace Route results are then displayed.

► **List TCP Connections:**

- Click the List TCP Connections title bar to show the list.

Downloading Diagnostic Information

Important: This function is for use by Raritan Field Engineers or when you are directed by Raritan Technical Support.

You can download the diagnostic file from the PX3 to a client machine. The file is compressed into a .tgz file and should be sent to Raritan Technical Support for interpretation.

This feature is accessible only by users with Administrative Privileges or Unrestricted View Privileges.

► **To retrieve a diagnostic file:**

- Choose Maintenance > Download Diagnostic >

Download Diagnostic

- The system prompts you to save or open the file. Click Save.
- E-mail this file as instructed by Raritan Technical Support.

Rebooting the PX3 Device

You can remotely reboot the PX3 device via the web interface.

Resetting the PX3 does not interrupt the operation of connected servers because there is no loss of power to outlets. During and after the reboot, outlets that have been powered on prior to the reboot remain powered on, and outlets that have been powered off remain powered off.

Warning: Rebooting the PX3 deletes all webcam snapshots that are saved on the PX3 locally. See *Viewing Saved Snapshots and Managing Storage* (on page 355).

► **To reboot the device:**

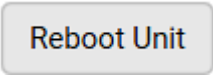
A rectangular button with rounded corners and a light gray background, containing the text "Reboot Unit" in a dark gray, sans-serif font.

1. Choose Maintenance > Unit Reset > .
2. Click Reboot to restart the PX3.
3. A message appears, with a countdown timer showing the remaining time of the operation. It takes about one minute to complete.
4. When the restart is complete, the login page opens.

Note: If you are not redirected to the login page after the restart is complete, click the text "this link" in the countdown message.

Resetting All Settings to Factory Defaults

You must have the Administrator Privileges to reset all settings of the PX3 to factory defaults.

Important: Exercise caution before resetting the PX3 to its factory defaults. This erases existing information and customized settings, such as user profiles, threshold values, and so on. Only active energy data and firmware upgrade history are retained.

► **To reset the device to factory defaults:**

1. Choose Maintenance > Unit Reset >

Reset to Factory Defaults

Factory Reset

Do you really want to reset the device to factory defaults?
Saying yes will clear all settings, including the network setup.

Cancel
Factory Reset

2. Click Factory Reset to reset the PX3 to factory defaults.
3. A message appears, with a countdown timer showing the remaining time of the operation. It takes about two minutes to complete.
4. When the reset is complete, the login page opens.

Note: If you are not redirected to the login page after the reset is complete, click the text "this link" in the countdown message.

► **Alternative:**

There are two more methods to reset the device to factory defaults.

- Use the "mechanical" reset button
- Perform the CLI command

For details, see *Resetting to Factory Defaults* (on page 585).

Retrieving Software Packages Information

You can check the current firmware version and the information of all open source packages embedded in the PX3 device through the web interface.

► **To retrieve the embedded software packages information:**

1. Choose Maintenance > About iPDU. A list of open source packages is displayed.
2. You can click any link to access related information or download any software package.

Webcam Management

The webcam-related menu items appear only when there are webcam(s) connected to the PX3. See *Connecting a Logitech Webcam* (on page 81).

With a Logitech® webcam connected to the PX3, you can visually monitor the environment around the PX3 via snapshots or videos captured by the webcam.

- To view snapshots and videos, you need the permission of either "Change Webcam Configuration" or "View Webcam Snapshots and Configuration."
- To configure webcam settings, you need the "Change Webcam Configuration" permission.

If your webcam supports audio transmission, audio will be available in live videos.

You can manually store snapshots taken from the webcam onto the PX3 or a remote server. See *Viewing Saved Snapshots and Managing Storage* (on page 355).

Links to snapshots or videos being captured by a webcam can be sent via email or instant message. See *Sending Snapshots or Videos in an Email or Instant Message* (on page 354).

You can create event rules to trigger emails containing snapshots from a webcam. See *Available Actions* (on page 289).

For more information on the Logitech webcam, see the user documentation accompanying it.

Configuring Webcams and Viewing Live Images

To configure the webcam or view live snapshot/video sessions, choose Webcam in the *Menu* (on page 132).

► Live Preview:

1. Click the Live Preview title bar to expand it.
2. The live snapshot/video session captured by the webcam is displayed.
 - The default is to show live snapshots. Interval time and the image captured time are displayed on the top of the image.
3. To save the current image, click Save Snapshot. See *Viewing Saved Snapshots and Managing Storage* (on page 355).
4. To have the live session also displayed in a Primary Standalone Live Preview window, click New Live Preview Window.

- You can send out this window's URL to share the live image with other users. See ***Sending Snapshots or Videos in an Email or Instant Message*** (on page 354).
5. To switch between snapshot and video modes, see the *Settings* section below.
 - In the video mode, the number of frames to take per second (fps) and the captured time are displayed on the top of the image.

▶ **Image Controls:**

1. Click the Image Controls title bar to expand it.
2. Adjust the brightness, contrast and saturation by adjusting the corresponding slide bar.
 - Or click "Set to Webcam Defaults" to restore all settings to this webcam's factory defaults.

▶ **Settings:**

1. Click Edit Settings.
2. Enter a name for the webcam. Up to 64 characters are supported.
3. Type the location information in each location field if needed. Up to 63 characters are supported.
4. Select a resolution for the webcam.
 - If you connect two webcams to one USB-A port using a powered USB hub, set the resolution to 352x288 or lower for optimal performance.
5. Select the webcam mode.
 - Video - the webcam enters the video mode. Set the Framerate (frames per second) rate.
 - Snapshot - the webcam shows static images from the webcam. Set the "Time Between Snapshots" rate as measured in seconds.
6. Click Save. The changes made to the settings are applied to the live session. See the above *Live Preview* section.

Note: The settings changes do not apply to those images captured prior to the changes.

Sending Snapshots or Videos in an Email or Instant Message

Whenever you open a Primary Standalone Live Preview window, a unique URL is generated for this window session. A URL supports a maximum of three sessions. Therefore, you can email or instant message up to two persons this URL. Recipients can then click on the provided link and view live snapshots or videos simultaneously.

*Tip: All Live Preview sessions sharing the same URL, including one Primary Standalone Live Preview window of the sender and two sessions of the remote recipients, are identified as one single "<webcam>" user in the Connected Users list. You can disconnect a "<webcam>" user to terminate all of the three sessions of a specific URL. See **Viewing Connected Users** (on page 338).*

For explanation of this topic, the message sender is User A and the two recipients are User B and C.

User C is able to access the snapshot or video image via the link in any of the following scenarios:

- The Primary Standalone Live Preview window remains open on User A's computer. If so, even though User A logs out of the web interface or the login session times out, the link remains available.
- Another recipient's live preview session based on the same URL remains open. That is, User B's session remains. If so, even though User A has closed the Primary Standalone Live Preview window, the link remains available.
- Neither User A's Primary Standalone Live Preview window nor User B's session based on the same URL remains open, but the idle timeout period has not expired yet since the last live preview window session was closed. For information on idle timeout, see **Configuring Login Settings** (on page 266).

Tip: When the idle timeout has not expired, the <webcam> user for that live preview URL remains shown on the Connected Users page.

Best Practice

As a best practice, User A should open the live snapshot or video session using a Primary Standalone Live Preview window and keep that window open at least until User C opens the live image session via the link.

Once User C opens the live session via the link, User A can close the Primary Standalone Live Preview window.

User C should let User A know that the link has been opened.

► **To send a snapshot or video link via email or instant message:**

1. Open the Webcam page by clicking it in the **Menu** (on page 132).

2. Click Live Preview > New Live Preview Window. The live snapshot or video in a standalone live preview window opens. See *Configuring Webcams and Viewing Live Images* (on page 352).
3. Copy the URL from the live preview window, and send it through an email or instant message application.
4. Leave the live preview window open until the recipient opens the snapshot or video via the link.

Viewing Saved Snapshots and Managing Storage

Once a snapshot is saved, it is stored locally on the PX3 by default. For instructions on saving snapshots, see *Configuring Webcams and Viewing Live Images* (on page 352).

Up to 10 images can be stored onto the PX3 at once. Unless snapshots are deleted manually, the oldest snapshot is automatically overridden by the newest one when the total of snapshots exceeds 10.

To save more than 10 snapshots, you must save the images on a Common Internet File System (CIFS)/Samba.

Snapshots are saved as JPG files, and named based on the sequential numbers, such as 1.jpg, 2.jpg, 3.jpg and so on.

Warning: Rebooting the PX3 deletes all webcam snapshots that are saved on the PX3 locally. See *Viewing Saved Snapshots and Managing Storage* (on page 355).

To view saved images or configure the storage settings, choose Webcam Snapshots in the *Menu* (on page 132).

► **To view and manage saved images:**



1. Click the snapshot you want to view from the list.
 - If the list of snapshots saved in the specified CIFS/Samba server exceeds one page, you can switch between available pages by clicking the pagination bar on the top.

If there are more than 5 pages and the page numbers displayed

in the bar does not show the desired one, click  to have it show the next or previous five page numbers, if available.



2. The selected snapshot as well as its information, such as captured time and resolution, is displayed on the same page.

3. If the latest saved snapshot is not listed yet, click  > Refresh on the top of the list.
4. To manually delete any images:
 - a. Select the checkboxes of the images you want to remove.
 - To select all images, select the top-most checkbox in the header row.
 - b. On the top of the list, click  > Delete Selected.
 - c. Click Delete on the confirmation message.

► **To configure the storage settings:**

1. Click  > Settings.
2. Click the Storage Type field to select the desired storage location and configure as needed.

Storage location	Description
Local	Local means the PX3. This is default.
CIFS/Samba	Snapshots will be saved on a Common Internet File System/Samba. Configure the following fields for this server: <ul style="list-style-type: none"> ▪ Server - the desired CIFS/Samba server ▪ Share/Folder - this is the share drive/folder ▪ Username - for server access ▪ Password - for server access

3. In the Capacity field, type values to determine the maximum number of snapshots that can be saved on the selected storage location.
4. Click Save.

Chapter 7 Using SNMP

This SNMP section helps you set up the PX3 for use with an SNMP manager. The PX3 can be configured to send traps or informs to an SNMP manager, as well as receive GET and SET commands in order to retrieve status and configure some basic settings.

In This Chapter

Enabling and Configuring SNMP.....	357
Downloading SNMP MIB	360
SNMP Gets and Sets.....	361

Enabling and Configuring SNMP

To communicate with an SNMP manager, you must enable SNMP protocols on the PX3. By default the "read-only" mode of SNMP v1/v2c is enabled.

The SNMP v3 protocol allows for encrypted communication. To take advantage of this, you must configure the users with the SNMP v3 access permission and set Authentication Pass Phrase and Privacy Pass Phrase, which act as shared secrets between SNMP and the PX3.

Important: You must download the SNMP MIB for your PX3 to use with your SNMP manager. See *Downloading SNMP MIB* (on page 360).

► **To enable SNMP v1/v2c and/or v3 protocols:**

1. Choose Device Settings > Network Services > SNMP.
2. In the SNMP Agent section, enable SNMP v1/v2c or SNMP v3, and configure related fields, such as the community strings.
 - If SNMP v3 is enabled, you must determine which users shall have the SNMP v3 access permission. See below.

For details, see *Configuring SNMP Settings* (on page 241).

► **To configure users for SNMP v3 access:**

1. Choose User Management > Users.
2. Create or modify users to enable their SNMP v3 access permission.
 - If authentication and privacy is enabled, configure the SNMP password(s) in the user settings.

For details, see *Creating Users* (on page 208).

► **To enable SNMP notifications:**

1. Choose Device Settings > Network Services > SNMP.
2. In the SNMP Notifications section, enable the SNMP notification feature, and configure related fields. For details, refer to:
 - **SNMPv2c Notifications** (on page 358)
 - **SNMPv3 Notifications** (on page 359)

*Note: Any changes made to the 'SNMP Notifications' section on the SNMP page will update the settings of the System SNMP Notification Action, and vice versa. See **Available Actions** (on page 289).*

SNMPv2c Notifications

1. Choose Device Settings > Network Services > SNMP.
2. In the SNMP Agent, make sure the Enable SNMP v1/v2c checkbox is selected.
3. In the SNMP Notifications section, make sure the Enable SNMP Notifications checkbox is selected.
4. Select SNMPv2c Trap or SNMPv2c Inform as the notification type.
5. Type values in the following fields.

Field	Description
Timeout	The interval of time, in seconds, after which a new inform communication is resent if the first is not received. <ul style="list-style-type: none"> ▪ For example, resend a new inform communication once every 3 seconds.
Number of Retries	The number of times you want to resend the inform communication if it fails. <ul style="list-style-type: none"> ▪ For example, inform communications are resent up to 5 times when the initial communication fails.
Host	The IP address of the device(s) you want to access. This is the address to which notifications are sent by the SNMP agent. You can specify up to 3 SNMP destinations.
Port	The port number used to access the device(s).
Community	The SNMP community string to access the device(s). The community is the group representing the PX3 and all SNMP management stations.

- Click Save.

SNMPv3 Notifications

- Choose Device Settings > Network Services > SNMP.
- In the SNMP Agent, make sure the Enable SNMP v1/v2c checkbox is selected.
- In the SNMP Notifications section, make sure the Enable SNMP Notifications checkbox is selected.
- Select SNMPv3 Trap or SNMPv3 Inform as the notification type.
- For SNMP TRAPs, the engine ID is prepopulated.
- Type values in the following fields.

Field	Description
Host	The IP address of the device(s) you want to access. This is the address to which notifications are sent by the SNMP agent.
Port	The port number used to access the device(s).
User ID	User name for accessing the device. <ul style="list-style-type: none"> Make sure the user has the SNMP v3 access permission.
Timeout	The interval of time, in seconds, after which a new inform communication is resent if the first is not received. <ul style="list-style-type: none"> For example, resend a new inform communication once every 3 seconds.
Number of Retries	Specify the number of times you want to resend the inform communication if it fails. <ul style="list-style-type: none"> For example, inform communications are resent up to 5 times when the initial communication fails.
Security Level	Three types are available. <ul style="list-style-type: none"> noAuthNoPriv - neither authentication nor privacy protocols are needed. AuthNoPriv - only authentication is required. authPriv - both authentication and privacy protocols are required.

Field	Description
Authentication Protocol, Authentication Passphrase, Confirm Authentication Passphrase	The three fields are available when the security level is set to AuthNoPriv or authPriv. <ul style="list-style-type: none"> ▪ Select the authentication protocol - MD5 or SHA ▪ Enter the authentication passphrase
Privacy Protocol, Privacy Passphrase, Confirm Privacy Passphrase	The three fields are available when the security level is set to authPriv. <ul style="list-style-type: none"> ▪ Select the Privacy Protocol - DES or AES ▪ Enter the privacy passphrase and then confirm the privacy passphrase

7. Click Save.

Downloading SNMP MIB

You must download an appropriate SNMP MIB file for successful SNMP communications. Always use the latest SNMP MIB downloaded from the current firmware of your PX3.

You can download the MIBs from two different pages of the web interface.

► **MIB download via the SNMP page:**

1. Choose Device Settings > Network Services > SNMP.
2. Click the Download MIBs title bar.



3. Select the desired MIB file to download.
 - PDU2-MIB: The SNMP MIB file for PX3 power management.
 - ASSETMANAGEMENT-MIB: The SNMP MIB file for asset management.
 - LHX-MIB: The SNMP MIB file for managing the LHX/SHX heat exchanger(s).
4. Click Save to save the file onto your computer.

► **MIB download via the Device Information page:**

1. Choose Maintenance > Device Information.
2. In the Information section, click the desired download link:
 - PDU2-MIB
 - ASSETMANAGEMENT-MIB
 - LHX MIB
3. Click Save to save the file onto your computer.

*Note: LHX-MIB is available only after the LHX/SHX support has been enabled. See **Miscellaneous** (on page 332).*

SNMP Gets and Sets

In addition to sending notifications, the PX3 is able to receive SNMP get and set requests from third-party SNMP managers.

- Get requests are used to retrieve information about the PX3, such as the system location, and the current on a specific outlet.
- Set requests are used to configure a subset of the information, such as the SNMP system name.

Note: The SNMP system name is the PX3 device name. When you change the SNMP system name, the device name shown in the web interface is also changed.

The PX3 does NOT support configuring IPv6-related parameters using the SNMP set requests.

Valid objects for these requests are limited to those found in the SNMP MIB-II System Group and the custom PX3 MIB.

The PX3 MIB

The SNMP MIB file is required for using your PX3 device with an SNMP manager. An SNMP MIB file describes the SNMP functions.

Layout

Opening the MIB reveals the custom objects that describe the PX3 system at the unit level as well as at the individual-outlet level.

As standard, these objects are first presented at the beginning of the file, listed under their parent group. The objects then appear again individually, defined and described in detail.

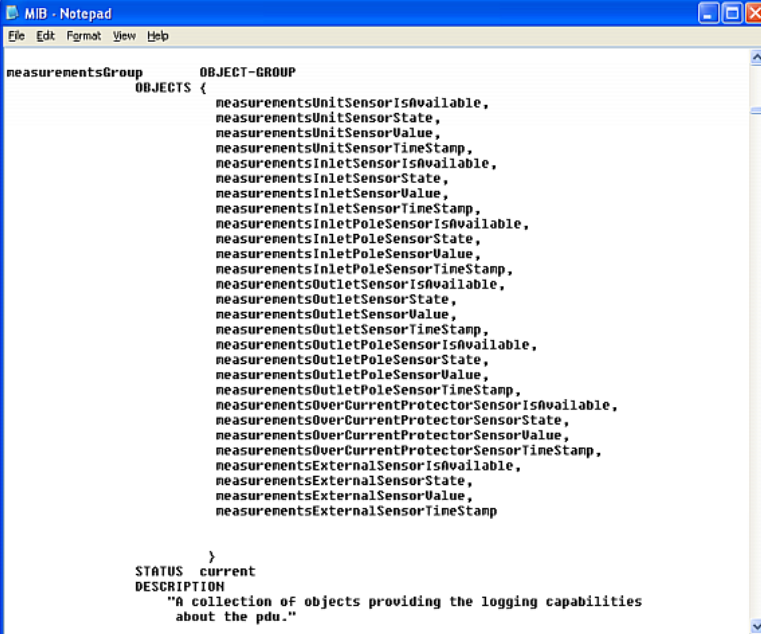

```

measurementsGroup      OBJECT-GROUP
                        OBJECTS {
                            measurementsUnitSensorIsAvailable,
                            measurementsUnitSensorState,
                            measurementsUnitSensorValue,
                            measurementsUnitSensorTimeStamp,
                            measurementsInletSensorIsAvailable,
                            measurementsInletSensorState,
                            measurementsInletSensorValue,
                            measurementsInletSensorTimeStamp,
                            measurementsInletPoleSensorIsAvailable,
                            measurementsInletPoleSensorState,
                            measurementsInletPoleSensorValue,
                            measurementsInletPoleSensorTimeStamp,
                            measurementsOutletSensorIsAvailable,
                            measurementsOutletSensorState,
                            measurementsOutletSensorValue,
                            measurementsOutletSensorTimeStamp,
                            measurementsOutletPoleSensorIsAvailable,
                            measurementsOutletPoleSensorState,
                            measurementsOutletPoleSensorValue,
                            measurementsOutletPoleSensorTimeStamp,
                            measurementsOverCurrentProtectorSensorIsAvailable,
                            measurementsOverCurrentProtectorSensorState,
                            measurementsOverCurrentProtectorSensorValue,
                            measurementsOverCurrentProtectorSensorTimeStamp,
                            measurementsExternalSensorIsAvailable,
                            measurementsExternalSensorState,
                            measurementsExternalSensorValue,
                            measurementsExternalSensorTimeStamp
                        }
                        STATUS current
                        DESCRIPTION
                            "A collection of objects providing the logging capabilities
                            about the pdu."

```

For example, the measurementsGroup group contains objects for sensor readings of PX3 as a whole. One object listed under this group, measurementsUnitSensorValue, is described later in the MIB as "The sensor value". pduRatedCurrent, part of the configGroup group, describes the PDU current rating.

SNMP Sets and Thresholds

Some objects can be configured from the SNMP manager using SNMP set commands. Objects that can be configured have a MAX-ACCESS level of "read-write" in the MIB.

These objects include threshold objects, which causes the PX3 to generate a warning and send an SNMP notification when certain parameters are exceeded. See *Sensor Threshold Settings* (on page 675) for a description of how thresholds work.

Note: When configuring the thresholds via SNMP set commands, ensure the value of upper critical threshold is higher than that of upper warning threshold.

Configuring NTP Server Settings

Using SNMP, you can change the following NTP server-related settings in the unitConfigurationTable:

- Enable or disable synchronization of the device's date and time with NTP servers (synchronizeWithNTPServer)
- Enable or disable the use of DHCP-assigned NTP servers if synchronization with NTP servers is enabled (useDHCPProvidedNTPServer)
- Manually assign the primary NTP server if the use of DHCP-assigned NTP servers is disabled (primaryNTPServerAddressType and primaryNTPServerAddress)
- Manually assign the secondary NTP server (optional) (secondaryNTPServerAddressType and secondaryNTPServerAddress)

*Tip: To specify the time zone, use the CLI or web interface instead. For the CLI, see **Setting the Time Zone** (on page 440). For the web interface, see **Setting the Date and Time** (on page 269).*

When using the SNMP SET command to specify or change NTP servers, it is required that both the NTP server's address type and address be set in the command line simultaneously.

For example, the SNMP command to change the primary NTP server's address from IPv4 (192.168.84.84) to host name looks similar to the following:

```
snmpset -v2c -c private 192.168.84.84
firstNTPServerAddressType = dns firstNTPServerAddress =
"angu.pep.com"
```

A Note about Enabling Thresholds

When enabling previously disabled thresholds via SNMP, make sure you set a correct value for all thresholds that are supposed to be enabled prior to actually enabling them. Otherwise, you may get an error message.

Chapter 8 Using the Command Line Interface

This section explains how to use the command line interface (CLI) to administer a PX3 device.

CLI commands are case sensitive.

In This Chapter

About the Interface.....	365
Logging in to CLI.....	366
Help Command.....	369
Querying Available Parameters for a Command.....	370
Showing Information.....	370
Clearing Information.....	402
Configuring the PX3 Device and Network.....	403
Load Shedding Configuration Commands.....	521
Power Control Operations.....	523
Actuator Control Operations.....	526
Unblocking a User.....	528
Resetting the PX3.....	528
Network Troubleshooting.....	530
Retrieving Previous Commands.....	533
Automatically Completing a Command.....	533
Logging out of CLI.....	534

About the Interface

The PX3 provides a command line interface that enables data center administrators to perform some basic management tasks.

Using this interface, you can do the following:

- Reset the PX3 device
- Display the PX3 and network information, such as the device name, firmware version, IP address, and so on
- Configure the PX3 and network settings
- Troubleshoot network problems

You can access the interface over a local connection using a terminal emulation program such as HyperTerminal, or via a Telnet or SSH client such as PuTTY.

*Note: Telnet access is disabled by default because it communicates openly and is thus insecure. To enable Telnet, see **Changing Telnet Settings** (on page 244).*

Logging in to CLI

Logging in via HyperTerminal over a local connection is a little different than logging in using SSH or Telnet.

If a security login agreement has been enabled, you must accept the agreement in order to complete the login. Users are authenticated first and the security banner is checked afterwards.

With HyperTerminal

You can use any terminal emulation programs for local access to the command line interface.

This section illustrates HyperTerminal, which is part of Windows operating systems prior to Windows Vista.

► **To log in using HyperTerminal:**

1. Connect your computer to the PX3 via a local connection.
2. Launch HyperTerminal on your computer and open a console window. When the window first opens, it is blank.

Make sure the COM port settings use this configuration:

- Bits per second = 115200 (115.2Kbps)
- Data bits = 8
- Stop bits = 1
- Parity = None
- Flow control = None

Tip: For a USB connection, you can determine the COM port by choosing Control Panel > System > Hardware > Device Manager, and locating the "Dominion PX2 Serial Console" under the Ports group.

3. In the communications program, press Enter to send a carriage return to the PX3. The Username prompt appears.

```
Username: _
```

4. Type a name and press Enter. The name is case sensitive. Then you are prompted to enter a password.

```
Username: admin
Password: _
```

5. Type a password and press Enter. The password is case sensitive.

After properly entering the password, the # or > system prompt appears. See *Different CLI Modes and Prompts* (on page 368) in the User Guide for more information.

Tip: The "Last Login" information, including the date and time, is also displayed if the same user profile was used to log in to this product's web interface or CLI.

6. You are now logged in to the command line interface and can begin administering the PX3.

With SSH or Telnet

You can remotely log in to the command line interface (CLI) using an SSH or Telnet client, such as PuTTY.

Note: PuTTY is a free program you can download from the Internet. See PuTTY's documentation for details on configuration.

► To log in using SSH or Telnet:

1. Ensure SSH or Telnet has been enabled. See *Configuring Network Services* (on page 239) in the User Guide.
2. Launch an SSH or Telnet client and open a console window. A login prompt appears.

```
login as: █
```

3. Type a name and press Enter. The name is case sensitive.

Note: If using the SSH client, the name must NOT exceed 25 characters. Otherwise, the login fails.

Then you are prompted to enter a password.

```
login as: admin
admin@192.168.84.88's password: █
```

4. Type a password and press Enter. The password is case sensitive.
5. After properly entering the password, the # or > system prompt appears. See *Different CLI Modes and Prompts* (on page 368) in the User Guide for more information.

Tip: The "Last Login" information, including the date and time, is also displayed if the same user profile was used to log in to this product's web interface or CLI.

6. You are now logged in to the command line interface and can begin administering the PX3.

With an Analog Modem

The PX3 supports remote access to the CLI via a connected analog modem. This feature is especially useful when the LAN access is not available.

► **To connect to the PX3 via the modem:**

1. Make sure the PX3 has an analog modem connected. See *Connecting an Analog Modem* (on page 83).
2. Make sure the computer you are using has an appropriate modem connected.
3. Launch a terminal emulation program, and configure its baud rate settings according to the baud rate set for the analog modem connected to the PX3. See *Configuring the Serial Port* (on page 325).
4. Type the following AT command to make a connection with the PX3.
`ATD<modem phone number>`
5. The CLI login prompt appears after the connection is established successfully. Then type the user name and password to log in to the CLI.

► **To disconnect from the PX3:**

1. Return to the modem's command mode using the escape code `+++`.
2. After the OK prompt appears, type the following AT command to disconnect from the PX3.
`ATH`

Different CLI Modes and Prompts

Depending on the login name you use and the mode you enter, the system prompt in the CLI varies.

- **User Mode:** When you log in as a normal user, who may not have full permissions to configure the PX3 device, the **>** prompt appears.
- **Administrator Mode:** When you log in as an administrator, who has full permissions to configure the PX3 device, the **#** prompt appears.
- **Configuration Mode:** You can enter the configuration mode from the administrator or user mode. In this mode, the prompt changes to **config:#** or **config:>** and you can change PX3 device and network configurations. See *Entering Configuration Mode* (on page 403).
- **Diagnostic Mode:** You can enter the diagnostic mode from the administrator or user mode. In this mode, the prompt changes to **diag:#** or **diag:>** and you can perform the network troubleshooting commands, such as the ping command. See *Entering Diagnostic Mode* (on page 530).

Closing a Local Connection

Close the window or terminal emulation program when you finish accessing a PX3 device over the local connection.

When accessing or upgrading multiple PX3 devices, do not transfer the local connection cable from one device to another without closing the local connection window first.

Help Command

The help (?) command shows a list of main CLI commands available for the current mode. This is helpful when you are not familiar with CLI commands.

▶ **Help command under the administrator mode:**

```
#          ?
```

▶ **Help command under the configuration mode:**

```
config:#  ?
```

▶ **Help command under the diagnostic mode:**

```
diag:#    ?
```

Press Enter after typing the help command, and a list of main commands for the current mode is displayed.

*Tip: You can check what parameters are available for a specific CLI command by adding the help command to the end of the queried command. See **Querying Available Parameters for a Command** (on page 370).*

Querying Available Parameters for a Command

If you are not sure what commands or parameters are available for a particular type of CLI command or its syntax, you can have the CLI show them by adding a space and the help command (?) to the end of that command. A list of available parameters and their descriptions will be displayed.

The following shows a few query examples.

- ▶ **To query available parameters for the "show" command:**

```
#          show ?
```

- ▶ **To query available parameters for the "show user" command:**

```
#          show user ?
```

- ▶ **To query available network configuration parameters:**

```
config:#   network ?
```

- ▶ **To query available role configuration parameters:**

```
config:#   role ?
```

- ▶ **To query available parameters for the "role create" command:**

```
config:#   role create ?
```

Showing Information

You can use the show commands to view current settings or the status of the PX3 device or part of it, such as the IP address, networking mode, firmware version, states or readings of internal or external sensors, user profiles, and so on.

Some "show" commands have two formats: one with the parameter "details" and the other without. The difference is that the command without the parameter "details" displays a shortened version of information while the other displays in-depth information.

After typing a "show" command, press Enter to execute it.

*Note: Depending on your login name, the # prompt may be replaced by the > prompt. See **Different CLI Modes and Prompts** (on page 368).*

Network Configuration

This command shows all network configuration and all network interfaces' information, such as the IP address, MAC address, the Ethernet interface's duplex mode, and the wireless interface's status/settings.

```
#          show network
```

IP Configuration

This command shows the IP-related configuration only, such as IPv4 and IPv6 configuration, address(es), gateway, and subnet mask.

*Tip: To show IPv4-only and IPv6-only configuration data, see **IPv4-Only or IPv6-Only Configuration** (on page 372).*

```
#          show network ip common
```

To show the IP-related configuration of a specific network interface, use the following command.

```
#          show network ip interface <ETH>
```

Variables:

- <ETH> is one of the network interfaces: *ethernet* (or *ETH1/ETH2*), *wireless*, *bridge* or *all*. Note that you must choose/configure the bridge interface if your PX3 is set to the bridging mode.

Note: In the bridging mode, only the IP parameters of the BRIDGE interface function. The IP parameters of the ETHERNET (or ETH1/ETH2) and WIRELESS interfaces do NOT function.

Option	Description
ethernet (PX3)	Show the IP-related configuration of the ETHERNET interface.
eth1 (PX3-iX7)	Show the IP-related configuration of the ETH1 interface.
eth2 (PX3-iX7)	Show the IP-related configuration of the ETH2 interface.
wireless	Show the IP-related configuration of the WIRELESS interface.

Option	Description
bridge	Show the IP-related configuration of the BRIDGE interface.
all	Show the IP-related configuration of all interfaces. You can type the CLI command without the word 'all.' For example, <i>show network ip interface</i> .

IPv4-Only or IPv6-Only Configuration

To show IPv4-only configuration or IPv6-only configuration, use any of the following commands.

*Tip: To show both IPv4 and IPv6 configuration data, see **IP Configuration** (on page 371).*

► **To show all IPv4 configuration:**

```
#          show network ipv4 common
```

► **To show all IPv6 configuration:**

```
#          show network ipv6 common
```

► **To show the IPv4 configuration of a specific network interface:**

```
#          show network ipv4 interface <ETH>
```

► **To show the IPv6 configuration of a specific network interface:**

```
#          show network ipv6 interface <ETH>
```

Variables:

- <ETH> is one of the network interfaces: *ethernet* (or *ETH1/ETH2*), *wireless*, *bridge* or *all*. Note that you must choose/configure the bridge interface if your PX3 is set to the bridging mode.

Note: In the bridging mode, only the IP parameters of the BRIDGE interface function. The IP parameters of the ETHERNET (or ETH1/ETH2) and WIRELESS interfaces do NOT function.

Option	Description
ethernet (PX3)	Show the IPv4 or IPv6 configuration of the ETHERNET interface.
eth1 (PX3-iX7)	Show the IPv4 or IPv6 configuration of the ETH1 interface.
eth2 (PX3-iX7)	Show the IPv4 or IPv6 configuration of the ETH2 interface.
wireless	Show the IPv4 or IPv6 configuration of the WIRELESS interface.
bridge	Show the IPv4 or IPv6 configuration of the BRIDGE interface.
all	Show the IPv4 or IPv6 configuration of all interfaces. You can type the CLI command without the word 'all.' For example, <i>show network ipv4 interface</i> .

Network Interface Settings

This command shows the specified network interface's information which is NOT related to IP configuration. For example, the Ethernet port's LAN interface speed and duplex mode, or the wireless interface's SSID parameter and authentication protocol.

```
# show network interface <ETH>
```

Variables:

- <ETH> is one of the network interfaces: *ethernet (or ETH1/ETH2), wireless, bridge* or *all*. Note that you must choose/configure the bridge interface if your PX3 is set to the bridging mode.

Note: In the bridging mode, only the IP parameters of the BRIDGE interface function. The IP parameters of the ETHERNET (or ETH1/ETH2) and WIRELESS interfaces do NOT function.

Option	Description
ethernet (PX3)	Show the ETHERNET interface's non-IP settings.
eth1 (PX3-iX7)	Show the ETH1 interface's non-IP settings.

Option	Description
eth2 (PX3-iX7)	Show the ETH2 interface's non-IP settings.
wireless	Show the WIRELESS interface's non-IP settings.
bridge	Show the BRIDGE interface's non-IP settings.
all	Show the non-IP settings of all interfaces. You can type the CLI command without the word 'all.' For example, <i>show network interface</i> .

Network Service Settings

This command shows the network service settings only, including the Telnet setting, TCP ports for HTTP, HTTPS, SSH and Modbus/TCP services, and SNMP settings.

```
# show network services <option>
```

Variables:

- <option> is one of the options: *all, http, https, telnet, ssh, snmp, modbus* and *zeroconfig*.

Option	Description
all	Displays the settings of all network services, including HTTP, HTTPS, Telnet, SSH and SNMP. <i>Tip: You can also type the command without adding this option "all" to get the same data.</i>
http	Only displays the TCP port for the HTTP service.
https	Only displays the TCP port for the HTTPS service.
telnet	Only displays the settings of the Telnet service.
ssh	Only displays the settings of the SSH service.
snmp	Only displays the SNMP settings.
modbus	Only displays the settings of the Modbus/TCP service.
zeroconfig	Only displays the settings of the zero configuration advertising.

PDU Configuration

This command shows the PDU configuration, such as the device name, firmware version and model type.

```
# show pdu
```

To show detailed information, add the parameter "details" to the end of the command.

```
# show pdu details
```

Outlet Information

This command syntax shows the outlet information.

```
# show outlets <n>
```

To show detailed information, add the parameter "details" to the end of the command.

```
# show outlets <n> details
```

Variables:

- <n> is one of the options: *all*, or a number.

Option	Description
all	Displays the information for all outlets. <i>Tip: You can also type the command without adding this option "all" to get the same data.</i>
A specific outlet number	Displays the information for the specified outlet only.

Displayed information:

- Without the parameter "details," only the outlet name and state are displayed.
- With the parameter "details," more outlet information is displayed in addition to the state, such as rated current, voltage, active power, active energy, and outlet settings.

Inlet Information

This command syntax shows the inlet information.

```
# show inlets <n>
```

To show detailed information, add the parameter "details" to the end of the command.

```
# show inlets <n> details
```

Variables:

- <n> is one of the options: *all*, or a number.

Option	Description
all	Displays the information for all inlets. <i>Tip: You can also type the command without adding this option "all" to get the same data.</i>
A specific inlet number	Displays the information for the specified inlet only. An inlet number needs to be specified only when there are more than 1 inlet on your PDU.

Displayed information:

- Without the parameter "details," only the inlet's name and RMS current are displayed.
- With the parameter "details," more inlet information is displayed in addition to the inlet name and RMS current, such as the inlet's RMS voltage, active power and active energy.

Overcurrent Protector Information

This command is only available for models with overcurrent protectors for protecting outlets.

This command syntax shows the overcurrent protector information, such as a circuit breaker or a fuse.

```
#          show ocp <n>
```

To show detailed information, add the parameter "details" to the end of the command.

```
#          show ocp <n> details
```

Variables:

- <n> is one of the options: *all*, or a number.

Option	Description
all	Displays the information for all overcurrent protectors. <i>Tip: You can also type the command without adding this option "all" to get the same data.</i>
A specific overcurrent protector number	Displays the information for the specified overcurrent protector only.

Displayed information:

- Without the parameter "details," only the overcurrent protector status and name are displayed.
- With the parameter "details," more overcurrent protector information is displayed in addition to status, such as the rating and RMS current value.

Date and Time Settings

This command shows the current date and time settings on the PX3 device.

```
# show time
```

To show detailed information, add the parameter "details" to the end of the command.

```
# show time details
```

Default Measurement Units

This command shows the default measurement units applied to the PX3 web and CLI interfaces across all users, especially those users authenticated through remote authentication servers.

```
# show user defaultPreferences
```

*Note: If a user has set his/her own preferred measurement units or the administrator has changed any user's preferred units, the web and CLI interfaces show the preferred measurement units for that user instead of the default ones after that user logs in to the PX3. See **Existing User Profiles** (on page 391) for the preferred measurement units for a specific user.*

Environmental Sensor Information

This command syntax shows the environmental sensor's information.

```
# show externalsensors <n>
```

To show detailed information, add the parameter "details" to the end of the command.

```
# show externalsensors <n> details
```

```
External sensor 3 ('Temperature 1')
Sensor type: Temperature
Reading:      31.8 deg C (normal)
```

```
Serial number:      AEI0950133
Description:        Not configured
Location:           X Not configured
                   Y Not configured
                   Z Not configured
Position:           Port 1
Using default thresholds: yes
```

Variables:

- <n> is one of the options: *all*, or a number.

Option	Description
all	Displays the information of all environmental sensors. <i>Tip: You can also type the command without adding this option "all" to get the same data.</i>
A specific environmental sensor number*	Displays the information for the specified environmental sensor only.

* The environmental sensor number is the ID number assigned to the sensor, which can be found on the Peripherals page of the PX3 web interface.

Displayed information:

- Without the parameter "details," only the sensor ID, sensor type and reading are displayed.

Note: A state sensor displays the sensor state instead of the reading.

- With the parameter "details," more information is displayed in addition to the ID number and sensor reading, such as the serial number, sensor position, and X, Y, and Z coordinates.

Note: DPX sensor packages do not provide chain position information.

Environmental Sensor Package Information

Different from the "show externalsensors" commands, which show the reading, status and configuration of an individual environmental sensor, the following command shows the information of all connected environmental sensor packages, each of which may contain more than one sensor or actuator.

```
# show peripheralDevicePackages
```

Information similar to the following is displayed. An environmental sensor package is a peripheral device package.

```
Peripheral Device Package 1
Serial Number:    AEI7A00022
Package Type:    DPX-T1H1
Position:        Port 1
Package State:   operational
Firmware Version: Not available
```

```
Peripheral Device Package 2
Serial Number:    AEI7A00021
Package Type:    DPX-T3H1
Position:        Port 1
Package State:   operational
Firmware Version: Not available
```

Actuator Information

This command syntax shows an actuator's information.

```
# show actuators <n>
```

To show detailed information, add the parameter "details" to the end of the command.

```
# show actuators <n> details
```

Variables:

- <n> is one of the options: *all*, or a number.

Option	Description
all	Displays the information for all actuators. <i>Tip: You can also type the command without adding this option "all" to get the same data.</i>
A specific actuator number*	Displays the information for the specified actuator only.

* The actuator number is the ID number assigned to the actuator. The ID number can be found using the PX3 web interface or CLI. It is an integer starting at 1.

Displayed information:

- Without the parameter "details," only the actuator ID, type and state are displayed.
- With the parameter "details," more information is displayed in addition to the ID number and actuator state, such as the serial number and X, Y, and Z coordinates.

Outlet Sensor Threshold Information

This command syntax shows the specified outlet sensor's threshold-related information.

```
#          show sensor outlet <n> <sensor type>
```

To show detailed information, add the parameter "details" to the end of the command.

```
#          show sensor outlet <n> <sensor type> details
```

Variables:

- <n> is the number of the outlet whose sensors you want to query.
- <sensor type> is one of the following sensor types:

Sensor type	Description
current	Current sensor
voltage	Voltage sensor
activePower	Active power sensor
apparentPower	Apparent power sensor
powerFactor	Power factor sensor
activeEnergy	Active energy sensor
lineFrequency	Line frequency sensor

Displayed information:

- Without the parameter "details," only the sensor reading, state, threshold, deassertion hysteresis and assertion timeout settings of the specified outlet sensor are displayed.
- With the parameter "details," more sensor information is displayed, including resolution and range.
- If the requested sensor type is not supported, the "Sensor is not available" message is displayed.

Outlet Pole Sensor Threshold Information

This command is available for an in-line monitor only, including PX2-3000 and PX3-3000 series.

This command syntax shows the specified outlet pole sensor's threshold-related information.

```
# show sensor outletpole <n> <p> <sensor type>
```

To show detailed information, add the parameter "details" to the end of the command.

```
# show sensor outletpole <n> <p> <sensor type> details
```

Variables:

- <n> is the number of the outlet whose pole sensors you want to query.
- <p> is the label of the outlet pole whose sensors you want to query.

Pole	Label <p>	Current sensor	Voltage sensor
1	L1	L1	L1 - L2
2	L2	L2	L2 - L3
3	L3	L3	L3 - L1

- <sensor type> is one of the following sensor types:

Sensor type	Description
current	Current sensor
voltage	Voltage sensor
activePower	Active power sensor
apparentPower	Apparent power sensor
powerFactor	Power factor sensor
activeEnergy	Active energy sensor

Displayed information:

- Without the parameter "details," only the reading, state, threshold, deassertion hysteresis and assertion delay settings of the specified outlet pole sensor are displayed.
- With the parameter "details," more sensor information is displayed, including resolution and range.
- If the requested sensor type is not supported, the "Sensor is not available" message is displayed.

Inlet Sensor Threshold Information

This command is NOT available for an in-line monitor (PX-3000 series).

This command syntax shows the specified inlet sensor's threshold-related information.

```
#          show sensor inlet <n> <sensor type>
```

To show detailed information, add the parameter "details" to the end of the command.

```
#          show sensor inlet <n> <sensor type> details
```

Variables:

- <n> is the number of the inlet whose sensors you want to query. For a single-inlet PDU, <n> is always the number 1.
- <sensor type> is one of the following sensor types:

Sensor type	Description
current	Current sensor
voltage	Voltage sensor
activePower	Active power sensor
apparentPower	Apparent power sensor
powerFactor	Power factor sensor
activeEnergy	Active energy sensor
unbalancedCurrent	Unbalanced load sensor
lineFrequency	Line frequency sensor

Displayed information:

- Without the parameter "details," only the reading, state, threshold, deassertion hysteresis and assertion timeout settings of the specified inlet sensor are displayed.
- With the parameter "details," more sensor information is displayed, including resolution and range.
- If the requested sensor type is not supported, the "Sensor is not available" message is displayed.

Inlet Pole Sensor Threshold Information

This command is only available for a three-phase PDU except for an in-line monitor (PX-3000 series).

This command syntax shows the specified inlet pole sensor's threshold-related information.

```
# show sensor inletpole <n> <p> <sensor type>
```

To show detailed information, add the parameter "details" to the end of the command.

```
# show sensor inletpole <n> <p> <sensor type> details
```

Variables:

- <n> is the number of the inlet whose pole sensors you want to query. For a single-inlet PDU, <n> is always the number 1.
- <p> is the label of the inlet pole whose sensors you want to query.

Pole	Label <p>	Current sensor	Voltage sensor
1	L1	L1	L1 - L2
2	L2	L2	L2 - L3
3	L3	L3	L3 - L1

- <sensor type> is one of the following sensor types:

Sensor type	Description
current	Current sensor
voltage	Voltage sensor
activePower	Active power sensor

Sensor type	Description
apparentPower	Apparent power sensor
powerFactor	Power factor sensor
activeEnergy	Active energy sensor

Displayed information:

- Without the parameter "details," only the reading, state, threshold, deassertion hysteresis and assertion timeout settings of the specified inlet pole sensor are displayed.
- With the parameter "details," more sensor information is displayed, including resolution and range.
- If the requested sensor type is not supported, the "Sensor is not available" message is displayed.

Overcurrent Protector Sensor Threshold Information

This command is only available for models with overcurrent protectors for protecting outlets.

This command syntax shows the specified overcurrent protector sensor's threshold-related information.

```
# show sensor ocp <n> <sensor type>
```

To show detailed information, add the parameter "details" to the end of the command.

```
# show sensor ocp <n> <sensor type> details
```

Variables:

- <n> is the number of the overcurrent protector whose sensors you want to query.
- <sensor type> is one of the following sensor types:

Sensor type	Description
current	Current sensor

Displayed information:

- Without the parameter "details," only the reading, state, threshold, deassertion hysteresis and assertion timeout settings of the specified overcurrent protector sensor are displayed.
- With the parameter "details," more sensor information is displayed, including resolution and range.

Environmental Sensor Threshold Information

This command syntax shows the specified environmental sensor's threshold-related information.

```
# show sensor externalsensor <n>
```

To show detailed information, add the parameter "details" to the end of the command.

```
# show sensor externalsensor <n> details
```

```
External sensor 3 (Temperature):
```

```
Reading: 31.8 deg C
```

```
State: normal
```

```
Active Thresholds: Sensor specific thresholds
```

```
Default Thresholds for Temperature sensors:
```

```
Lower critical threshold: 10.0 deg C
```

```
Lower warning threshold: 15.0 deg C
```

```
Upper warning threshold: 30.0 deg C
```

```
Upper critical threshold: 35.0 deg C
```

```
Deassertion hysteresis: 1.0 deg C
```

```
Assertion timeout: 0 samples
```

```
Sensor Specific Thresholds:
```

```
Lower critical threshold: 8.0 deg C
```

```
Lower warning threshold: 13.0 deg C
```

```
Upper warning threshold: 28.0 deg C
```

```
Upper critical threshold: 33.0 deg C
```

```
Deassertion hysteresis: 1.0 deg C
```

```
Assertion timeout: 0 samples
```

Variables:

- <n> is the environmental sensor number. The environmental sensor number is the ID number assigned to the sensor, which can be found on the Peripherals page of the PX3 web interface.

Displayed information:

- Without the parameter "details," only the reading, threshold, deassertion hysteresis and assertion timeout settings of the specified environmental sensor are displayed.
- With the parameter "details," more sensor information is displayed, including resolution and range.

Note: For a state sensor, the threshold-related and accuracy-related data is NOT available.

Environmental Sensor Default Thresholds

This command syntax shows a certain sensor type's default thresholds, which are the initial thresholds applying to the specified type of sensor.

```
# show defaultThresholds <sensor type>
```

To show detailed information, add the parameter "details" to the end of the command.

```
# show defaultThresholds <sensor type> details
```

Variables:

- <sensor type> is one of the following numeric sensor types:

Sensor types	Description
absoluteHumidity	Absolute humidity sensors
relativeHumidity	Relative humidity sensors
temperature	Temperature sensors
airPressure	Air pressure sensors
airFlow	Air flow sensors
vibration	Vibration sensors
all	All of the above numeric sensors
	<i>Tip: You can also type the command without adding this option "all" to get the same data.</i>

Displayed information:

- Without the parameter "details," only the default upper and lower thresholds, deassertion hysteresis and assertion timeout settings of the specified sensor type are displayed.
- With the parameter "details," the threshold range is displayed in addition to default thresholds settings.

Security Settings

This command shows the security settings of the PX3.

```
# show security
```

To show detailed information, add the parameter "details" to the end of the command.

```
# show security details
```

Displayed information:

- Without the parameter "details," the information including IP access control, role-based access control, password policy, and HTTPS encryption is displayed.
- With the parameter "details," more security information is displayed, such as user blocking time, user idle timeout and front panel permissions (if supported by your model).

Existing User Profiles

This command shows the data of one or all existing user profiles.

```
# show user <user_name>
```

To show detailed information, add the parameter "details" to the end of the command.

```
# show user <user_name> details
```

Variables:

- <user_name> is the name of the user whose profile you want to query. The variable can be one of the options: *all* or a user's name.

Option	Description
all	This option shows all existing user profiles. <i>Tip: You can also type the command without adding this option "all" to get the same data.</i>
a specific user's name	This option shows the profile of the specified user only.

Displayed information:

- Without the parameter "details," only four pieces of user information are displayed: user name, user "Enabled" status, SNMP v3 access privilege, and role(s).
- With the parameter "details," more user information is displayed, such as the telephone number, e-mail address, preferred measurement units and so on.

Existing Roles

This command shows the data of one or all existing roles.

```
# show roles <role_name>
```

Variables:

- <role_name> is the name of the role whose permissions you want to query. The variable can be one of the following options:

Option	Description
all	This option shows all existing roles. <i>Tip: You can also type the command without adding this option "all" to get the same data.</i>
a specific role's name	This option shows the data of the specified role only.

Displayed information:

- Role settings are displayed, including the role description and privileges.

Load Shedding Settings

This section applies to outlet-switching capable models only.

This command shows the load shedding settings.

```
# show loadshedding
```

Displayed information:

- The load shedding state is displayed along with non-critical outlets.

*Note: The load shedding mode is associated with critical and non-critical outlets. To specify critical and non-critical outlets through CLI, see **Specifying Non-Critical Outlets** (on page 408).*

Serial Port Settings

This command shows the baud rate setting of the serial port labeled CONSOLE / MODEM on the PX3 device.

```
# show serial
```

EnergyWise Settings

This command shows the PX3 device's current configuration for Cisco® EnergyWise.

```
# show energywise
```

Asset Strip Settings

This command shows the asset strip settings, such as the total number of rack units (tag ports), asset strip state, numbering mode, orientation, available tags and LED color settings.

```
# show assetStrip <n>
```

Variables:

- <n> is one of the options: *all*, or a number.

Option	Description
all	Displays all asset strip information. <i>Tip: You can also type the command without adding this option "all" to get the same data.</i>
A specific asset strip number	Displays the settings of the asset strip connected to the specified FEATURE port number. For the PX3 device with only one FEATURE port, the valid number is always 1.

Rack Unit Settings of an Asset Strip

A rack unit refers to a tag port on the asset strips. This command shows the settings of a specific rack unit or all rack units on an asset strip, such as a rack unit's LED color and LED mode.

```
#          show rackUnit <n> <rack_unit>
```

Variables:

- <n> is the number of the FEATURE port where the selected asset strip is physically connected. For the PX3 device with only one FEATURE port, the number is always 1.
- <rack_unit> is one of the options: *all* or a specific rack unit's index number.

Option	Description
all	Displays the settings of all rack units on the specified asset strip. <i>Tip: You can also type the command without adding this option "all" to get the same data.</i>
A specific number	Displays the settings of the specified rack unit on the specified asset strip. Use the index number to specify the rack unit. The index number is available on the asset strip or the Asset Strip page of the web interface.

Blade Extension Strip Settings

This command shows the information of a blade extension strip, including the total number of tag ports, and if available, the ID (barcode) number of any connected tag.

```
# show bladeSlot <n> <rack_unit> <slot>
```

Variables:

- <n> is the number of the FEATURE port where the selected asset strip is physically connected. For the PX3 device with only one FEATURE port, the number is always 1.
- <rack_unit> is the index number of the desired rack unit (tag port) on the selected asset strip. The index number is available on the asset strip or the Asset Strip page of the web interface.
- <slot> is one of the options: *all* or a specific number of a tag port on the blade extension strip.

Option	Description
all	Displays the information of all tag ports on the specified blade extension strip connected to a particular rack unit. <i>Tip: You can also type the command without adding this option "all" to get the same data.</i>
A specific number	Displays the information of the specified tag port on the blade extension strip connected to a particular rack unit. The number of each tag port on the blade extension strip is available on the Asset Strip page.

Event Log

The command used to show the event log begins with `show eventlog`. You can add either the *limit* or *class* parameters or both to show specific events.

▶ **Show the last 30 entries:**

```
# show eventlog
```

▶ **Show a specific number of last entries in the event log:**

```
# show eventlog limit <n>
```

▶ **Show a specific type of events only:**

```
# show eventlog class <event_type>
```

▶ **Show a specific number of last entries associated with a specific type of events only:**

```
# show eventlog limit <n> class <event_type>
```

Variables:

- <n> is one of the options: *all* or a number.

Option	Description
all	Displays all entries in the event log.
An integer number	Displays the specified number of last entries in the event log. The number ranges between 1 to 10,000.

- <event_type> is one of the following event types.

Event type	Description
all	All events.
device	Device-related events, such as system starting or firmware upgrade event.
userAdministration	User management events, such as a new user profile or a new role.
userActivity	User activities, such as login or logout.
pdu	Displays PDU-related events, such as entry or exit of the load shedding mode.

Event type	Description
sensor	Internal or external sensor events, such as state changes of any sensors.
serverMonitor	Server-monitoring records, such as a server being declared reachable or unreachable.
assetManagement	Raritan asset management events, such as asset tag connections or disconnections.
lhx	Schroff® LHX/SHX heat exchanger events.
modem	Modem-related events.
timerEvent	Scheduled action events.
webcam	Events for webcam management, if available.
cardReader	Events for card reader management, if available.
energywise	Cisco EnergyWise-related events, such as enabling the support of the EnergyWise function.

Wireless LAN Diagnostic Log

This command shows the diagnostic log for the wireless LAN connection.

```
#          show wlanlog
```

Server Reachability Information

This command shows all server reachability information with a list of monitored servers and status.

```
#          show serverReachability
```

Server Reachability Information for a Specific Server

To show the server reachability information for a certain IT device only, use the following command.

```
# show serverReachability server <n>
```

To show detailed information, add the parameter "details" to the end of the command.

```
# show serverReachability server <n> details
```

Variables:

- <n> is a number representing the sequence of the IT device in the monitored server list.
You can find each IT device's sequence number using the CLI command of `show serverReachability` as illustrated below.

```
-----
# IP address      Enabled  Status
-----
1 192.168.84.126  Yes     Waiting for reliable connection
2 www.raritan.com  Yes     Waiting for reliable connection
```

Displayed information:

- Without the parameter "details," only the specified device's IP address, monitoring enabled/disabled state and current status are displayed.
- With the parameter "details," more settings for the specified device are displayed, such as number of pings and wait time prior to the next ping.

Command History

This command syntax shows the command history for current connection session.

```
# show history
```

Displayed information:

- A list of commands that were previously entered in the current session is displayed.

History Buffer Length

This command syntax shows the length of the history buffer for storing history commands.

```
# show history bufferlength
```

Displayed information:

- The current history buffer length is displayed.

Reliability Data

This command shows the reliability data.

```
# show reliability data
```

Reliability Error Log

This command shows the reliability error log.

```
# show reliability errorlog <n>
```

Variables:

- <n> is one of the options: 0 (zero) or any other integer number.

Option	Description
0	Displays all entries in the reliability error log. <i>Tip: You can also type the command without adding this option "0" to get all data.</i>

Option	Description
A specific integer number	Displays the specified number of last entries in the reliability error log.

Examples

This section provides examples of the show command.

Example 1 - Basic Security Information

The diagram shows the output of the *show security* command.

```
# show security
IPv4 access control: Disabled
IPv6 access control: Disabled
Role based access control for IPv4: Disabled
Role based access control for IPv6: Disabled
Password aging: Disabled
Prevent concurrent user login: No
Strong passwords: Disabled
Enforce HTTPS for web access: Yes
Restricted Service Agreement: disabled
```

Example 2 - In-Depth Security Information

More information is displayed when typing the *show security details* command.

```
# show security details
IPv4 access control: Disabled
IPv6 access control: Disabled

Role based access control for IPv4: Disabled
Role based access control for IPv6: Disabled
Password aging: Disabled

Prevent concurrent user login: No
Maximum number of failed logins: 3
User block time: 10 minutes

User idle timeout: 1440 minutes

Strong passwords: Disabled
Enforce HTTPS for web access: Yes

Restricted Service Agreement: disabled
Restricted Service Agreement Banner Content:
Unauthorized access prohibited; all access and activities not explicitly authorized by management are unauthorized. All activities are monitored and logged. There is no privacy on this system. Unauthorized access and activities or any criminal activity will be reported to appropriate authorities.
```

Example 3 - Basic PDU Information

The diagram shows the output of the *show pdu* command.

```
# show pdu
PDU 'my PX'
Model: PX3-XXXX
Firmware Version: 2.X.0.5-40956
```

Example 4 - In-Depth PDU Information

More information is displayed when typing the *show pdu details* command. Displayed information varies depending on the model you purchased.

```
# show pdu details
PDU 'my PX'
Model:          PX3-XXXX
Firmware Version: 2.X.0.5-40956
Serial Number:  06Z3792136
Board Revision: 0x01

Voltage rating: 200-240V
Current rating: 16A
Frequency rating: 50/60Hz
Power rating:   3.2-3.8kVA

Sensor data retrieval:      Enabled
Measurements per log entry: 60

External sensor Z coordinate format: Rack units
Device altitude:            0 m
```

Clearing Information

You can use the clear commands to remove unnecessary data from the PX3.

After typing a "clear" command, press Enter to execute it.

*Note: Depending on your login name, the # prompt may be replaced by the > prompt. See **Different CLI Modes and Prompts** (on page 368).*

Clearing Event Log

This command removes all data from the event log.

```
#          clear eventlog

-- OR --

#          clear eventlog /y
```

If you entered the command without "/y," a message appears, prompting you to confirm the operation. Type *y* to clear the event log or *n* to abort the operation.

If you type *y*, a message "Event log was cleared successfully" is displayed after all data in the event log is deleted.

Clearing WLAN Log

This command removes all data from the diagnostic log for the wireless LAN (WLAN) connection.

```
#          clear wlanlog

-- OR --

#          clear wlanlog /y
```

If you entered the command without `/y`, a message appears, prompting you to confirm the operation. Type `y` to clear the WLAN log or `n` to abort the operation.

If you type `y`, a message "WLAN log was cleared successfully" is displayed to indicate all data in the WLAN log has been deleted.

Configuring the PX3 Device and Network

To configure the PX3 device or network settings through the CLI, it is highly recommended to log in as the administrator so that you have full permissions.

To configure any settings, enter the configuration mode. Configuration commands are case sensitive so ensure you capitalize them correctly.

Entering Configuration Mode

Configuration commands function in configuration mode only.

► **To enter configuration mode:**

1. Ensure you have entered administrator mode and the `#` prompt is displayed.

*Note: If you enter configuration mode from user mode, you may have limited permissions to make configuration changes. See **Different CLI Modes and Prompts** (on page 368).*

2. Type `config` and press Enter.
3. The `config:#` prompt appears, indicating that you have entered configuration mode.

```
config:# _
```

4. Now you can type any configuration command and press Enter to change the settings.

Important: To apply new configuration settings, you must issue the

"apply" command before closing the terminal emulation program. Closing the program does not save any configuration changes. See *Quitting Configuration Mode* (on page 404).

Quitting Configuration Mode

Both of "apply" and "cancel" commands let you quit the configuration mode. The difference is that "apply" saves all changes you made in the configuration mode while "cancel" aborts all changes.

► **To quit the configuration mode, use either command:**

```
config:#    apply
           -- OR --
config:#    cancel
```

The # or > prompt appears after pressing Enter, indicating that you have entered the administrator or user mode. See *Different CLI Modes and Prompts* (on page 368).

PDU Configuration Commands

A PDU configuration command begins with *pdu*. You can use the PDU configuration commands to change the settings that apply to the whole PX3 device.

Changing the PDU Name

This command changes the PX3 device's name.

```
config:#    pdu name "<name>"
```

Variables:

- <name> is a string comprising up to 32 ASCII printable characters. The <name> variable must be enclosed in quotes when it contains spaces.

Setting the Outlet Relay Behavior

This section applies to outlet-switching capable models only.

This command syntax determines the relay behavior of all outlets on a PX3 model.

```
config:# pdu relayBehaviorOnPowerLoss <option>
```

Variables:

- <option> is one of the options: *latching* or *nonLatching*.

*Note: For more information on the outlet relay behavior, see **PX3 Latching Relay Behavior** (on page 150).*

Setting the Outlet Power-On Sequence

This section applies to outlet-switching capable models only.

This command sets the outlet power-on sequence when the PDU powers up.

```
config:# pdu outletSequence <option>
```

Variables:

- <option> is one of the options: *default*, or a comma-separated list of outlet numbers.

Option	Description
default	All outlets are switched ON in the ASCENDING order (from outlet 1 to the final outlet) when the PX3 device powers up.
A comma-separated list of outlet numbers	All outlets are switched ON in the order you specify using the comma-separated list. The list must include all outlets on the PDU.

*Note: Power-on sequencing is disabled in the latching mode. See **PX3 Latching Relay Behavior** (on page 150).*

Setting the Outlet Power-On Sequence Delay

This section applies to outlet-switching capable models only.

This command sets the delays (in seconds) for outlets when turning on all outlets in sequence.

```
config:# pdu outletSequenceDelay <outlet1>:<delay1>;<outlet2>:<delay2>;
<outlet3>:<delay3>;...
```

Separate outlet numbers and their delay settings with a colon. Outlets followed by delays are separated with a semicolon.

Variables:

- <outlet1>, <outlet2>, <outlet3> and the like are individual outlet numbers or a range of outlets using a dash. For example, 3-8 represents outlets 3 to 8.
- <delay1>, <delay2>, <delay3> and the like are the delay time in seconds.

*Note: Power-on sequencing is disabled in the latching mode. See **PX3 Latching Relay Behavior** (on page 150).*

Setting the PDU-Defined Default Outlet State

This section applies to outlet-switching capable models only.

This command determines the initial power condition of all outlets after powering up the PDU.

```
config:# pdu outletStateOnDeviceStartup <option>
```

Variables:

- <option> is one of the options: *off*, *on* or *lastKnownState*.

Option	Description
off	Switches OFF all outlets when the PX3 device powers up.
on	Switches ON all outlets when the PX3 device powers up.

Option	Description
lastKnownState	Restores all outlets to the previous status before powering down the PX3 device when the PDU powers up again.

*Note: This feature does NOT take effect and cannot be configured on a PX3 device after the outlet relay is set to the "Latching" mode. See **PX3 Latching Relay Behavior** (on page 150).*

Setting the PDU-Defined Cycling Power-Off Period

This section applies to outlet-switching capable models only.

This command sets the power-off period of the power cycling operation for all outlets.

```
config:# pdu cyclingPowerOffPeriod <timing>
```

Variables:

- <timing> is the time of the cycling power-off period in seconds, which is an integer between 0 and 3600, or *pduDefined* for following the PDU-defined timing.

Setting the Inrush Guard Delay Time

This section applies to outlet-switching capable models only.

This command sets the inrush guard delay.

```
config:# pdu inrushGuardDelay <timing>
```

Variables:

- <timing> is a delay time between 100 and 100000 milliseconds.

Setting the Outlet Initialization Delay

This section applies to outlet-switching capable models only.

This command determines the outlet initialization delay timing on device startup. See **PDU** (on page 145) for information on outlet initialization delay.

```
config:# pdu outletInitializationDelayOnDeviceStartup <timing>
```

Variables:

- <timing> is a delay time between 1 and 3600 seconds.

*Note: This feature does NOT take effect and cannot be configured on a PX3 device after the outlet relay is set to the "Latching" mode. See **PX3 Latching Relay Behavior** (on page 150).*

Specifying Non-Critical Outlets

This section applies to outlet-switching capable models only.

This command determines critical and non-critical outlets. It is associated with the load shedding mode. See **Load Shedding Mode** (on page 164).

```
config:# pdu nonCriticalOutlets <outlets1>:false;<outlets2>:true
```

Separate outlet numbers and their settings with a colon. Separate each "false" and "true" setting with a semicolon.

Variables:

- <outlets1> is one or multiple outlet numbers to be set as critical outlets. Use commas to separate outlet numbers.
Use a dash for a range of consecutive outlets. For example, 3-8 represents outlets 3 to 8.
- <outlets2> is one or multiple outlet numbers to be set as NON-critical outlets. Use commas to separate outlet numbers.
Use a dash for a range of consecutive outlets. For example, 3-8 represents outlets 3 to 8.

Enabling or Disabling Data Logging

This command enables or disables the data logging feature.

```
config:# pdu dataRetrieval <option>
```

Variables:

- <option> is one of the options: *enable* or *disable*.

Option	Description
enable	Enables the data logging feature.
disable	Disables the data logging feature.

For more information, see *Setting Data Logging* (on page 317).

Setting Data Logging Measurements Per Entry

This command defines the number of measurements accumulated per log entry.

```
config:# pdu measurementsPerLogEntry <number>
```

Variables:

- <number> is an integer between 1 and 600. The default is 60 samples per log entry.

For more information, see *Setting Data Logging* (on page 317).

Specifying the Device Altitude

This command specifies your PX3 device's altitude above sea level (in meters). You must specify the PX3 device's altitude above sea level if a Raritan's DPX differential air pressure sensor is attached. This is because the device's altitude is associated with the altitude correction factor. See ***Altitude Correction Factors*** (on page 684).

```
config:# pdu deviceAltitude <altitude>
```

Variables:

- <altitude> is an integer between 1 and 3000 meters.

Setting the Z Coordinate Format for Environmental Sensors

This command enables or disables the use of rack units for specifying the height (Z coordinate) of environmental sensors.

```
config:# pdu externalSensorsZCoordinateFormat <option>
```

Variables:

- <option> is one of the options: *rackUnits* or *freeForm*.

Option	Description
rackUnits	The height of the Z coordinate is measured in standard rack units. When this is selected, you can type a numeric value in the rack unit to describe the Z coordinate of any environmental sensors or actuators.
freeForm	Any alphanumeric string can be used for specifying the Z coordinate.

Note: After determining the format for the Z coordinate, you can set a value for it. See **Setting the Z Coordinate** (on page 489).

Enabling or Disabling Peripheral Device Auto Management

This command enables or disables the Peripheral Device Auto Management feature.

```
config:# pdu peripheralDeviceAutoManagement <option>
```

Variables:

- <option> is one of the options: *enable* or *disable*.

Option	Description
enable	Enables the automatic management feature for environmental sensor packages.
disable	Disables the automatic management feature for environmental sensor packages.

For more information, see *How the Automatic Management Function Works* (on page 152).

Examples

This section illustrates several PDU configuration examples.

Example 1 - PDU Naming

The following command assigns the name "my px12" to the PDU.

```
config:# pdu name "my px12"
```

Example 2 - Outlet Sequence

The following command causes a 10-outlet PDU to first power on the 8th to 6th outlets and then the rest of outlets in the ascending order after the PDU powers up.

```
config:# pdu outletSequence 8-6,1-5,9,10
```

Example 3 - Outlet Sequence Delay

The following command determines that the outlet 1's delay is 2.5 seconds, outlet 2's delay is 3 seconds, and the delay for outlets 3 through 5 is 10 seconds.

```
config:# pdu outletSequenceDelay 1:2.5;2:3;3-5:10
```

Example 4 - Non-Critical Outlets

The following command sets outlets 1, 2, 3, 7, and 9 to be critical outlets, and 4, 5, 6, 8, 10, 11 and 12 to be non-critical outlets on a 12-outlet PX3.

```
config:# pdu nonCriticalOutlets 1-3,7,9:false;4-6,8,10-12:true
```

Network Configuration Commands

A network configuration command begins with *network*. A number of network settings can be changed through the CLI, such as the IP address, transmission speed, duplex mode, and so on.

Configuring IPv4 Parameters

An IPv4 configuration command begins with *network ipv4*.

Setting the IPv4 Configuration Mode

This command determines the IP configuration mode.

```
config:# network ipv4 interface <ETH> configMethod <mode>
```

Variables:

- <ETH> is one of the network interfaces: *ethernet* (or *ETH1/ETH2*), *wireless*, *bridge* or *all*. Note that you must choose/configure the bridge interface if your PX3 is set to the bridging mode.

Note: In the bridging mode, only the IP parameters of the BRIDGE interface function. The IP parameters of the ETHERNET (or ETH1/ETH2) and WIRELESS interfaces do NOT function.

Interface	Description
ethernet (PX3)	Determine the IPv4 configuration mode of the ETHERNET interface (that is, wired networking).
eth1 (PX3-iX7)	Determine the IPv4 configuration mode of the ETH1 interface (wired networking).
eth2 (PX3-iX7)	Determine the IPv4 configuration mode of the ETH2 interface (wired networking).
wireless	Determine the IPv4 configuration mode of the WIRELESS interface (that is, wireless networking).

Interface	Description
bridge	Determine the IPv4 configuration mode of the BRIDGE interface (that is, bridging mode).

- <mode> is one of the modes: *dhcp* or *static*.

Mode	Description
dhcp	The IPv4 configuration mode is set to DHCP.
static	The IPv4 configuration mode is set to static IP address.

Setting the IPv4 Preferred Host Name

After selecting DHCP as the IPv4 configuration mode, you can specify the preferred host name, which is optional. The following is the command:

```
config:# network ipv4 interface <ETH> preferredHostName <name>
```

Variables:

- <ETH> is one of the network interfaces: *ethernet* (or *ETH1/ETH2*), *wireless*, *bridge* or *all*. Note that you must choose/configure the bridge interface if your PX3 is set to the bridging mode.

Note: In the bridging mode, only the IP parameters of the BRIDGE interface function. The IP parameters of the ETHERNET (or ETH1/ETH2) and WIRELESS interfaces do NOT function.

Interface	Description
ethernet (PX3)	Determine the IPv4 preferred host name of the ETHERNET interface (that is, wired networking).
eth1 (PX3-iX7)	Determine the IPv4 preferred host name of the ETH1 interface (that is, wired networking).
eth2 (PX3-iX7)	Determine the IPv4 preferred host name of the ETH2 interface (that is, wired networking).
wireless	Determine the IPv4 preferred host name of the WIRELESS interface (that is, wireless networking).
bridge	Determine the IPv4 preferred host name of the BRIDGE interface (that is, bridging mode).

- <name> is a host name which:
 - Consists of alphanumeric characters and/or hyphens
 - Cannot begin or end with a hyphen
 - Cannot contain more than 63 characters
 - Cannot contain punctuation marks, spaces, and other symbols

Setting the IPv4 Address

After selecting the static IP configuration mode, you can use this command to assign a permanent IP address to the PX3 device.

```
config:# network ipv4 interface <ETH> address <ip address>
```

Variables:

- <ETH> is one of the network interfaces: *ethernet* (or *ETH1/ETH2*), *wireless*, *bridge* or *all*. Note that you must choose/configure the bridge interface if your PX3 is set to the bridging mode.

Note: In the bridging mode, only the IP parameters of the BRIDGE interface function. The IP parameters of the ETHERNET (or ETH1/ETH2) and WIRELESS interfaces do NOT function.

Interface	Description
ethernet (PX3)	Determine the IPv4 address of the ETHERNET interface (that is, wired networking).
eth1 (PX3-iX7)	Determine the IPv4 address of the ETH1 interface (that is, wired networking).
eth2 (PX3-iX7)	Determine the IPv4 address of the ETH2 interface (that is, wired networking).
wireless	Determine the IPv4 address of the WIRELESS interface (that is, wireless networking).
bridge	Determine the IPv4 address of the BRIDGE interface (that is, the bridging mode).

- <ip address> is the IP address being assigned to your PX3 device. Its format is "IP address/prefix". For example, *192.168.84.99/32*.

Setting the IPv4 Gateway

After selecting the static IP configuration mode, you can use this command to specify the gateway.

```
config:# network ipv4 gateway <ip address>
```

Variables:

- <ip address> is the IP address of the gateway. The value ranges from 0.0.0.0 to 255.255.255.255.

Setting IPv4 Static Routes

If the IPv4 network mode is set to static IP and your local network contains two subnets, you can configure static routes to enable or disable communications between the PX3 and devices in the other subnet.

These commands are prefixed with *network ipv4 staticRoutes*.

Depending on whether the other network is directly reachable or not, there are two methods for adding a static route. For further information, see **Static Route Examples** (on page 227).

- ▶ **Method 1: add a static route when the other network is NOT directly reachable:**

```
config:# network ipv4 staticRoutes add <dest-1> <hop>
```

- ▶ **Method 2: add a static route when the other network is directly reachable:**

```
config:# network ipv4 staticRoutes add <dest-1> interface <ETH>
```

- ▶ **Delete an existing static route:**

```
config:# network ipv4 staticRoutes delete <route_ID>
```

- ▶ **Modify an existing static route:**

```
config:# network ipv4 staticRoutes modify <route_ID> <dest-2> <hop>
-- OR --
```

```
config:# network ipv4 staticRoutes modify <route_ID> <dest-2> interface <ETH>
```

Variables:

- <dest-1> is a combination of the IP address and subnet mask of the other subnet. The format is *IP address/subnet mask*.
- <hop> is the IP address of the next hop router.
- <ETH> is one of the interfaces: *ethernet (or ETH1/ETH2), wireless and bridge*. Type "bridge" only when your PX3 is in the bridging mode.
- <route_ID> is the ID number of the route setting which you want to delete or modify.
- <dest-2> is a modified route setting that will replace the original route setting. Its format is *IP address/subnet mask*. You can modify either the IP address or the subnet mask or both.

Configuring IPv6 Parameters

An IPv6 configuration command begins with *network ipv6*.

Setting the IPv6 Configuration Mode

This command determines the IP configuration mode.

```
config:# network ipv6 interface <ETH> configMethod <mode>
```

Variables:

- <ETH> is one of the network interfaces: *ethernet (or ETH1/ETH2), wireless, bridge or all*. Note that you must choose/configure the bridge interface if your PX3 is set to the bridging mode.

Note: In the bridging mode, only the IP parameters of the BRIDGE interface function. The IP parameters of the ETHERNET (or ETH1/ETH2) and WIRELESS interfaces do NOT function.

Interface	Description
ethernet (PX3)	Determine the IPv6 configuration mode of the ETHERNET interface (that is, wired networking).
eth1 (PX3-iX7)	Determine the IPv6 configuration mode of the ETH1 interface (wired networking).

Interface	Description
eth2 (PX3-iX7)	Determine the IPv6 configuration mode of the ETH2 interface (wired networking).
wireless	Determine the IPv6 configuration mode of the WIRELESS interface (that is, wireless networking).
bridge	Determine the IPv6 configuration mode of the BRIDGE interface (that is, bridging mode).

- <mode> is one of the modes: *automatic* or *static*.

Mode	Description
automatic	The IPv6 configuration mode is set to automatic.
static	The IPv6 configuration mode is set to static IP address.

Setting the IPv6 Preferred Host Name

After selecting DHCP as the IPv6 configuration mode, you can specify the preferred host name, which is optional. The following is the command:

```
config:# network ipv6 interface <ETH> preferredHostName <name>
```

Variables:

- <ETH> is one of the network interfaces: *ethernet* (or *ETH1/ETH2*), *wireless*, *bridge* or *all*. Note that you must choose/configure the bridge interface if your PX3 is set to the bridging mode.

Note: In the bridging mode, only the IP parameters of the BRIDGE interface function. The IP parameters of the ETHERNET (or ETH1/ETH2) and WIRELESS interfaces do NOT function.

Interface	Description
ethernet (PX3)	Determine the IPv6 preferred host name of the ETHERNET interface (that is, wired networking).
eth1 (PX3-iX7)	Determine the IPv6 preferred host name of the ETH1 interface (wired networking).
eth2 (PX3-iX7)	Determine the IPv6 preferred host name of the ETH2 interface (wired networking).

Interface	Description
wireless	Determine the IPv6 preferred host name of the WIRELESS interface (that is, wireless networking).
bridge	Determine the IPv6 preferred host name of the BRIDGE interface (that is, bridging mode).

- <name> is a host name which:
 - Consists of alphanumeric characters and/or hyphens
 - Cannot begin or end with a hyphen
 - Cannot contain more than 63 characters
- Cannot contain punctuation marks, spaces, and other symbols

Setting the IPv6 Address

After selecting the static IP configuration mode, you can use this command to assign a permanent IP address to the PX3 device.

```
config:# network ipv6 interface <ETH> address <ip
address>
```

Variables:

- <ETH> is one of the network interfaces: *ethernet (or ETH1/ETH2), wireless, bridge* or *all*. Note that you must choose/configure the bridge interface if your PX3 is set to the bridging mode.

Note: In the bridging mode, only the IP parameters of the BRIDGE interface function. The IP parameters of the ETHERNET (or ETH1/ETH2) and WIRELESS interfaces do NOT function.

Interface	Description
ethernet (PX3)	Determine the IPv6 address of the ETHERNET interface (that is, wired networking).
eth1 (PX3-iX7)	Determine the IPv6 address of the ETH1 interface (wired networking).
eth2 (PX3-iX7)	Determine the IPv6 address of the ETH2 interface (wired networking).
wireless	Determine the IPv6 address of the WIRELESS interface (that is, wireless networking).

Interface	Description
bridge	Determine the IPv6 address of the BRIDGE interface (that is, the bridging mode).

- <ip address> is the IP address being assigned to your PX3 device. This value uses the IPv6 address format. Note that you must add /xx, which indicates a prefix length of bits such as /64, to the end of this IPv6 address.

Setting the IPv6 Gateway

After selecting the static IP configuration mode, you can use this command to specify the gateway.

```
config:# network ipv6 gateway <ip address>
```

Variables:

- <ip address> is the IP address of the gateway. This value uses the IPv6 address format.

Setting IPv6 Static Routes

If the IPv6 network mode is set to static IP and your local network contains two subnets, you can configure static routes to enable or disable communications between the PX3 and devices in the other subnet.

These commands are prefixed with *network ipv6 staticRoutes*.

Depending on whether the other network is directly reachable or not, there are two methods for adding a static route. For further information, see ***Static Route Examples*** (on page 227).

▶ **Method 1: add a static route when the other network is NOT directly reachable:**

```
config:# network ipv6 staticRoutes add <dest-1> <hop>
```

▶ **Method 2: add a static route when the other network is directly reachable:**

```
config:# network ipv6 staticRoutes add <dest-1> interface <ETH>
```

▶ **Delete an existing static route:**

```
config:# network ipv6 staticRoutes delete <route_ID>
```

▶ **Modify an existing static route:**

```
config:# network ipv6 staticRoutes modify <route_ID> <dest-2> <hop>
```

-- OR --

```
config:# network ipv6 staticRoutes modify <route_ID> <dest-2> interface <ETH>
```

Variables:

- <dest-1> is the IP address and prefix length of the subnet where the PX3 belongs. The format is *IP address/prefix length*.
- <hop> is the IP address of the next hop router.
- <ETH> is one of the interfaces: *ethernet (or ETH1/ETH2), wireless* and *bridge*. Type "bridge" only when your PX3 is in the bridging mode.
- <route_ID> is the ID number of the route setting which you want to delete or modify.
- <dest-2> is a modified route setting that will replace the original route setting. Its format is *IP address/prefix length*. You can modify either the IP address or the prefix length or both.

Configuring DNS Parameters

Use the following commands to configure DNS-related settings.

▶ **Specify the primary DNS server:**

```
config:# network dns firstServer <ip address>
```

▶ **Specify the secondary DNS server:**

```
config:# network dns secondServer <ip address>
```

▶ **Specify the third DNS server:**

```
config:# network dns thirdServer <ip address>
```

▶ **Determine which IP address is used when the DNS server returns both IPv4 and IPv6 addresses:**

```
config:# network dns resolverPreference <resolver>
```

Variables:

- <ip address> is the IP address of the DNS server.
- <resolver> is one of the options: *preferV4* or *preferV6*.

Option	Description
preferV4	Use the IPv4 addresses returned by the DNS server.
preferV6	Use the IPv6 addresses returned by the DNS server.

Setting LAN Interface Parameters

A LAN interface configuration command begins with *network ethernet*.

Enabling or Disabling the LAN Interface

This command enables or disables the LAN interface.

```
config:# network ethernet <ETH> enabled <option>
```

Variables:

- <ETH> is one of the options -- *ethernet*, *eth1*, or *eth2*, which depends on your model.

Option	Description
ethernet (PX3)	ETHERNET port of the PX3 model.
eth1 (PX3-iX7)	ETH1 port of the iX7™ model.
eth2 (PX3-iX7)	ETH2 port of the iX7™ model.

- <option> is one of the options: *true* or *false*.

Option	Description
true	The specified network interface is enabled.
false	The specified network interface is disabled.

Changing the LAN Interface Speed

This command determines the LAN interface speed.

```
config:# network ethernet <ETH> speed <option>
```

Variables:

- <ETH> is one of the options -- *ethernet*, *eth1*, or *eth2*, which depends on your model.

Option	Description
ethernet (PX3)	ETHERNET port of the PX3 model.
eth1 (PX3-iX7)	ETH1 port of the iX7™ model.
eth2 (PX3-iX7)	ETH2 port of the iX7™ model.

- <option> is one of the options: *auto*, *10Mbps*, *100Mbps* or *1000Mbps*.

Option	Description
auto	System determines the optimum LAN speed through auto-negotiation.
10Mbps	The LAN speed is always 10 Mbps.
100Mbps	The LAN speed is always 100 Mbps.
1000Mbps	This option is only available on PX3-iX7 models or specific PX3 models with the suffix "-G1". The LAN speed is always 1000 Mbps.

Changing the LAN Duplex Mode

This command determines the LAN interface duplex mode.

```
config:# network ethernet <ETH> duplexMode <mode>
```

Variables:

- <ETH> is one of the options -- *ethernet*, *eth1*, or *eth2*, which depends on your model.

Option	Description
ethernet (PX3)	ETHERNET port of the PX3 model.
eth1 (PX3-iX7)	ETH1 port of the iX7™ model.
eth2 (PX3-iX7)	ETH2 port of the iX7™ model.

- <mode> is one of the modes: *auto*, *half* or *full*.

Option	Description
auto	The PX3 selects the optimum transmission mode through auto-negotiation.
half	Half duplex: Data is transmitted in one direction (to or from the PX3 device) at a time.

Option	Description
full	Full duplex: Data is transmitted in both directions simultaneously.

Setting Wireless Parameters

You must configure wireless parameters, including Service Set Identifier (SSID), authentication method, Pre-Shared Key (PSK), and Basic Service Set Identifier (BSSID) after the wireless networking mode is enabled.

A wireless configuration command begins with *network wireless*.

Note: If current networking mode is not wireless, the SSID, PSK and BSSID values are not applied until the networking mode is changed to "wireless." In addition, a message appears, indicating that the active network interface is not wireless.

Setting the SSID

This command specifies the SSID string.

```
config:# network wireless SSID <ssid>
```

Variables:

- <ssid> is the name of the wireless access point, which consists of:
 - Up to 32 ASCII characters
 - No spaces
 - ASCII codes 0x20 ~ 0x7E

Setting the Authentication Method

This command sets the wireless authentication method to either PSK or Extensible Authentication Protocol (EAP).

```
config:# network wireless authMethod <method>
```

Variables:

- <method> is one of the authentication methods: *PSK* or *EAP*.

Method	Description
PSK	The wireless authentication method is set to PSK.

Method	Description
EAP	The wireless authentication method is set to EAP.

Setting the PSK

If the Pre-Shared Key (PSK) authentication method is selected, you must assign a PSK passphrase by using this command.

```
config:# network wireless PSK <psk>
```

Variables:

- <psk> is a string or passphrase that consists of:
 - 8 to 63 characters
 - No spaces
 - ASCII codes 0x20 ~ 0x7E

Setting EAP Parameters

When the wireless authentication method is set to EAP, you must configure EAP authentication parameters, including outer authentication, inner authentication, EAP identity, password, and CA certificate.

▶ **Determine the outer authentication protocol:**

```
config:# network wireless eapOuterAuthentication <outer_auth>
```

▶ **Determine the inner authentication protocol:**

```
config:# network wireless eapInnerAuthentication <inner_auth>
```

▶ **Set the EAP identity:**

```
config:# network wireless eapIdentity <identity>
```

▶ **Set the EAP password:**

```
config:# network wireless eapPassword
```

After performing the above command, the PX3 prompts you to enter the password. Then type the password and press Enter.

▶ **Provide a CA TLS certificate:**

```
config:# network wireless eapCACertificate
```

After performing the above command, the system prompts you to enter the CA certificate's contents. For details, see **EAP CA Certificate Example** (on page 428).

▶ **Enable or disable verification of the TLS certificate chain:**

```
config:# network wireless enableCertVerification <option1>
```

▶ **Allow expired and not yet valid TLS certificates:**

```
config:# network wireless allowOffTimeRangeCerts <option2>
```

▶ **Allow wireless network connection with incorrect system time:**

```
config:# network wireless allowConnectionWithIncorrectClock <option3>
```

Variables:

- The value of <outer_auth> is *PEAP* because PX3 only supports Protected Extensible Authentication Protocol (PEAP) as the outer authentication.
- The value of <inner_auth> is *MSCHAPv2* because PX3 only supports Microsoft's Challenge Authentication Protocol Version 2 (MSCHAPv2) as the inner authentication.
- <identity> is your user name for the EAP authentication.
- <option1> is one of the options: *true* or *false*.

Option	Description
true	Enables the verification of the TLS certificate chain.
false	Disables the verification of the TLS certificate chain.

- <option2> is one of the options: *true* or *false*.

Option	Description
true	Always make the wireless network connection successful even though the TLS certificate chain contains any certificate which is outdated or not valid yet.
false	The wireless network connection is NOT successfully established when the TLS certificate chain contains any certificate which is outdated or not valid yet.

- <option3> is one of the options: *true* or *false*.

Option	Description
true	Make the wireless network connection successful when the PX3 system time is earlier than the firmware build before synchronizing with the NTP server, causing the TLS certificate to become invalid.

Option	Description
false	The wireless network connection is NOT successfully established when the PX3 finds that the TLS certificate is not valid due to incorrect system time.

EAP CA Certificate Example

This section provides a CA certificate example only. Your CA certificate contents should be different from the contents displayed in this example.

► **To provide a CA certificate:**

1. Make sure you have entered the configuration mode. See *Entering Configuration Mode* (on page 403).
2. Type the following command and press Enter.

```
config:# network wireless eapCACertificate
```
3. The system prompts you to enter the contents of the CA certificate.
4. Open a CA certificate using a text editor. You should see certificate contents similar to the following.

```

--- BEGIN CERTIFICATE ---
MIICjTCCAfigAwIBAgIEMaYgRzALBgkqhkiG9w0BAQQwRTELMAkGA1UEBhMCVVMx
NjA0BgNVBAoTLU5hdGlvbmFsIEFlcm9uYXV0aWNzIGFuZCBTcGFjZSBBZG1pbmlz
dHJhdGlvbjAmFxE5NjA1MjgxmzQ5MDUrMDgwMBCROTgwNTI4MTM0OTA1KzA4MDAw
ZzELMAkGA1UEBhMCVVMxNjA0BgNVBAoTLU5hdGlvbmFsIEFlcm9uYXV0aWNzIGFu
ZCBTcGFjZSBBZG1pbmlzdHJhdGlvbjEgMAkGA1UEBRMCMTYwEwYDVQQDEwxTdGV2
ZSBTY2hvY2gwWDALBgkqhkiG9w0BAQEESQAwwRgJBALrAwyYdgxmzNP/ts0Uyf6Bp
miJYktU/w4NG67ULaN4B5CnEz7k57s9o3YY3LecETgQ5iQHmkwlyDfTL2ftgVfw0C
AQOjgaswgagwZAYDVR0ZAQH/BFowWDBWmfQxCzAJBgNVBAYTAiVTMTYwNAAYDVQQK
Ey1OYXRpb25hbCBZJvbmF1dGJjcyBhbmQgU3BhY2UgQWRtaW5pc3RyYXRpb24x
DTALBgNVBAMTBENSTDEwFwYDVROBAQH/BA0wC4AJODMyOTcwODEwMBGGA1UdAgQR
MA8ECTgzMjk3MDgyM4ACBSAwDQYDVROKBAYwBAMCBkAwCwYJKoZIhvcNAQEEA4GB
AH2y1VCEw/A4zaXzSYZJTTUi3uawbbFiS2yxHvgf28+8Js0OHXk1H1w2d6qOHH21
X82tZXd/0JtG0g1T9usFFBDvYK800ebgz/P5ELJnBL2+atObEuJy1ZZ0pBDWINR3
WkDNLCGiTkCKp0F5EWIrVDwh54NNeVkcQRZita+z4IBO
--- END CERTIFICATE ---

```

5. Select and copy the contents as illustrated below, excluding the starting line containing "BEGIN CERTIFICATE" and the ending line containing "END CERTIFICATE."

```
MIICjTCCAf igAwIBAgIEMaYgRzALBgkqhkiG9w0BAQQwRTELMak
GA1UEBhMCMVVMxNjA0BgNVBAoTLU5hdGlvbmFsIEFlcm9uYXV0aW
NzIGFuZCBTcGFjZSBBZG1pbmlzdHJhdGlvbjAmFxE5NjA1MjgxM
zQ5MDUzMdUwMDgwMBCROTgwNTI4MTM0OTA1KzA4MDAwZzELMAkGA1UE
BhMCMVVMxNjA0BgNVBAoTLU5hdGlvbmFsIEFlcm9uYXV0aWNzIGF
uZCBTcGFjZSBBZG1pbmlzdHJhdGlvbjEgMAkGA1UEBRMCMTYwEw
YDVQDEwxdGV2ZSBTY2hvY2gwWDALBgkqhkiG9w0BAQEDSQAAR
gJBALrAwYydgxmzNP / ts0Uyf6BpmiJYktU / w4NG67ULa4B5CnE
z7k57s9o3YY3LecETgQ5iQHmkwlyDTL2fTgVfw0CAQOjgaswgag
wZAYDVR0ZAQH / BFowWDBWFMFQxCzAJBgNVBAYTAlVTMTYwNAYDVQ
QKEy1OYXRpb25hbCBZBZjvbmF1dG1jcyBhbmQgU3BhY2UgQWRta
W5pc3RyYXRpb24xDALBgNVBAMTBENSTDEwFwYDVR0BAQH / BA0w
C4AJODMyOTcwODEwMBGGA1UdAgQRMA8ECTgzMjk3MDgyM4ACBSA
wDQYDVR0KBAYwBAMCBkAwCwYJKoZIhvcNAQEEA4GBAH2y1VCEw /
A4zaXzSYZJTTUi3uawbbFiS2yxHvgf28+8Js0OHXk1H1w2d6qOH
H21X82tZXd / 0JtG0g1T9usFFBDvYK800ebgz / P5ELJnBL2+atOb
EuJy1ZZ0pBDWINR3WkDNLCGiTkCKp0F5EWIrVDwh54NNEvkCQRZ
ita+z4IBO
```

6. Paste the contents in the terminal.
7. Press Enter.
8. Verify whether the system shows the following command prompt, indicating the provided CA certificate is valid.

```
config:#
```

Setting the BSSID

This command specifies the BSSID.

```
config:# network wireless BSSID <bssid>
```

Variables:

- <bssid> is either the MAC address of the wireless access point or *none* for automatic selection.

Configuring the Cascading Mode

This command determines the cascading mode.

```
config:# network <mode> enabled <option1>
```

Variables:

- <mode> is one of the following cascading modes.

Important: When enabling either cascading mode, you must make sure the other cascading mode is disabled, or the preferred

cascading mode may not be enabled successfully.

Mode	Description
bridge	The network bridging mode, where each cascaded device is assigned a unique IP address.
portForwarding	The port forwarding mode, where every cascaded device in the chain shares the same IP address, with diverse port numbers assigned.

- <option1> is one of the following options:

Option	Description
true	The selected cascading mode is enabled.
false	The selected cascading mode is disabled.

- ▶ **If Port Forwarding mode is enabled, you must configure two more settings to finish the configuration:**

On ALL cascaded devices, you must configure the 'role' setting one by one.

```
config:# network portForwarding role <option2>
```

On the master device, you must configure the 'downstream interface' setting.

```
config:# network portForwarding
        masterDownstreamInterface <option3>
```

Variables:

- <option2> is one of the following cascading roles:

Role	Description
master	The device is a master device.
slave	The device is a slave device.

- <option3> is one of the following options:

Option	Description
Ethernet (or ETH1/ETH2)	Ethernet (or ETH1/ETH2) port is the port where the 1st slave device is connected.
Usb	USB port is the port where the 1st slave device is connected.

Setting Network Service Parameters

A network service command begins with *network services*.

Setting the HTTP Port

The commands used to configure the HTTP port settings begin with *network services http*.

► **Change the HTTP port:**

```
config:# network services http port <n>
```

► **Enable or disable the HTTP port:**

```
config:# network services http enabled <option>
```

Variables:

- <n> is a TCP port number between 1 and 65535. The default HTTP port is 80.
- <option> is one of the options: *true* or *false*.

Option	Description
true	The HTTP port is enabled.
false	The HTTP port is disabled.

Setting the HTTPS Port

The commands used to configure the HTTPS port settings begin with *network services https*.

► **Change the HTTPS port:**

```
config:# network services https port <n>
```

► **Enable or disable the HTTPS access:**

```
config:# network services https enabled <option>
```

Variables:

- <n> is a TCP port number between 1 and 65535. The default HTTPS port is 443.
- <option> is one of the options: *true* or *false*.

Option	Description
true	Forces any access to the PX3 via HTTP to be redirected to HTTPS.
false	No HTTP access is redirected to HTTPS.

Changing the Telnet Configuration

You can enable or disable the Telnet service, or change its TCP port using the CLI commands.

A Telnet command begins with *network services telnet*.

Enabling or Disabling Telnet

This command enables or disables the Telnet service.

```
config:# network services telnet enabled <option>
```

Variables:

- <option> is one of the options: *true* or *false*.

Option	Description
true	The Telnet service is enabled.

Option	Description
false	The Telnet service is disabled.

Changing the Telnet Port

This command changes the Telnet port.

```
config:# network services telnet port <n>
```

Variables:

- <n> is a TCP port number between 1 and 65535. The default Telnet port is 23.

Changing the SSH Configuration

You can enable or disable the SSH service, or change its TCP port using the CLI commands.

An SSH command begins with *network services ssh*.

Enabling or Disabling SSH

This command enables or disables the SSH service.

```
config:# network services ssh enabled <option>
```

Variables:

- <option> is one of the options: *true* or *false*.

Option	Description
true	The SSH service is enabled.
false	The SSH service is disabled.

Changing the SSH Port

This command changes the SSH port.

```
config:# network services ssh port <n>
```

Variables:

- <n> is a TCP port number between 1 and 65535. The default SSH port is 22.

Determining the SSH Authentication Method

This command syntax determines the SSH authentication method.

```
config:# network services ssh authentication <auth_method>
```

Variables:

- <option> is one of the options: *passwordOnly*, *publicKeyOnly* or *passwordOrPublicKey*.

Option	Description
passwordOnly	Enables the password-based login only.
publicKeyOnly	Enables the public key-based login only.
passwordOrPublicKey	Enables both the password- and public key-based login. This is the default.

If the public key authentication is selected, you must enter a valid SSH public key for each user profile to log in over the SSH connection. See *Specifying the SSH Public Key* (on page 476).

Setting the SNMP Configuration

You can enable or disable the SNMP v1/v2c or v3 agent, configure the read and write community strings, or set the MIB-II parameters, such as sysContact, using the CLI commands.

An SNMP command begins with *network services snmp*.

Enabling or Disabling SNMP v1/v2c

This command enables or disables the SNMP v1/v2c protocol.

```
config:# network services snmp v1/v2c <option>
```

Variables:

- <option> is one of the options: *enable* or *disable*.

Option	Description
enable	The SNMP v1/v2c protocol is enabled.
disable	The SNMP v1/v2c protocol is disabled.

Enabling or Disabling SNMP v3

This command enables or disables the SNMP v3 protocol.

```
config:# network services snmp v3 <option>
```

Variables:

- <option> is one of the options: *enable* or *disable*.

Option	Description
enable	The SNMP v3 protocol is enabled.
disable	The SNMP v3 protocol is disabled.

Setting the SNMP Read Community

This command sets the SNMP read-only community string.

```
config:# network services snmp readCommunity <string>
```

Variables:

- <string> is a string comprising 4 to 64 ASCII printable characters.
- The string CANNOT include spaces.

Setting the SNMP Write Community

This command sets the SNMP read/write community string.

```
config:# network services snmp writeCommunity <string>
```

Variables:

- <string> is a string comprising 4 to 64 ASCII printable characters.
- The string CANNOT include spaces.

Setting the sysContact Value

This command sets the SNMP MIB-II sysContact value.

```
config:# network services snmp sysContact <value>
```

Variables:

- <value> is a string comprising 0 to 255 alphanumeric characters.

Setting the sysName Value

This command sets the SNMP MIB-II sysName value.

```
config:# network services snmp sysName <value>
```

Variables:

- <value> is a string comprising 0 to 255 alphanumeric characters.

Setting the sysLocation Value

This command sets the SNMP MIB-II sysLocation value.

```
config:# network services snmp sysLocation <value>
```

Variables:

<value> is a string comprising 0 to 255 alphanumeric characters.

Changing the Modbus Configuration

You can enable or disable the Modbus agent, configure its read-only capability, or change its TCP port.

A Modbus command begins with *network services modbus*.

Enabling or Disabling Modbus

This command enables or disables the Modbus protocol.

```
config:# network services modbus enabled <option>
```

Variables:

- <option> is one of the options: *true* or *false*.

Option	Description
true	The Modbus agent is enabled.
false	The Modbus agent is disabled.

Enabling or Disabling the Read-Only Mode

This command enables or disables the read-only mode for the Modbus agent.

```
config:# network services modbus readonly <option>
```

Variables:

- <option> is one of the options: *true* or *false*.

Option	Description
true	The read-only mode is enabled.
false	The read-only mode is disabled.

Changing the Modbus Port

This command changes the Modbus port.

```
config:# network services modbus port <n>
```

Variables:

- <n> is a TCP port number between 1 and 65535. The default Modbus port is 502.

Enabling or Disabling Service Advertising

This command enables or disables the zero configuration protocol, which enables advertising or auto discovery of network services. See ***Enabling Service Advertising*** (on page 246) for details.

```
config:# network services zeroconfig enabled <option>
```

Variables:

- <option> is one of the options: *true* or *false*.

Option	Description
true	The zero configuration protocol is enabled.
false	The zero configuration protocol is disabled.

Examples

This section illustrates several network configuration examples.

Example 1 - Networking Mode

The following command enables the wired networking mode.

```
config:# network mode wired
```

Example 2 - Enabling Both IP Protocols

The following command determines that both IPv4 and IPv6 protocols are enabled.

```
config:# network ip proto both
```

Example 3 - Wireless Authentication Method

The following command sets the wireless authentication method to PSK.

```
config:# network wireless authMethod PSK
```

Example 4 - Static IPv4 Configuration

The following command enables the Static IP configuration mode.

```
config:# network ipv4 ipConfigurationMode static
```

Time Configuration Commands

A time configuration command begins with *time*.

Determining the Time Setup Method

This command determines the method to configure the system date and time.

```
config:# time method <method>
```

Variables:

- <method> is one of the time setup options: *manual* or *ntp*.

Mode	Description
manual	The date and time settings are customized.
ntp	The date and time settings synchronize with a specified NTP server.

Setting NTP Parameters

A time configuration command that is used to set the NTP parameters begins with *time ntp*.

Specifying the Primary NTP Server

This command specifies the primary time server if synchronization with the NTP server is enabled.

```
config:# time ntp firstServer <first_server>
```

Variables:

- The <first_server> is the IP address or host name of the primary NTP server.

Specifying the Secondary NTP Server

This command specifies the primary time server if synchronization with the NTP server is enabled.

```
config:# time ntp secondServer <second_server>
```

Variables:

- The <second_server> is the IP address or host name of the secondary NTP server.

Overriding DHCP-Assigned NTP Servers

This command determines whether the customized NTP server settings override the DHCP-specified NTP servers.

```
config:#    time ntp overrideDHCPProvidedServer <option>
```

Variables:

- <option> is one of these options: *true* or *false*.

Mode	Description
true	Customized NTP server settings override the DHCP-specified NTP servers.
false	Customized NTP server settings do NOT override the DHCP-specified NTP servers.

Deleting an NTP Server

The following commands delete the primary and/or secondary time server(s).

► **To delete the primary time server:**

```
config:#    time ntp firstServer ""
```

► **To delete the secondary time server:**

```
config:#    time ntp secondServer ""
```

Setting the Time Zone

The CLI has a list of time zones to configure the date and time for the PX3.

```
config:#    time zone
```

After a list of time zones is displayed, type the index number of the time zone or press Enter to cancel.

Example**► To set the time zone:**

1. Type the time zone command as shown below and press Enter.

```
config:# time zone
```
2. The system shows a list of time zones. Type the index number of the desired time zone and press Enter.
3. Type `apply` for the selected time zone to take effect.

Customizing the Date and Time

If intending to manually configure the date and time, use the following CLI commands to specify them.

*Note: You shall set the time configuration method to "manual" prior to customizing the date and time. See **Determining the Time Setup Method** (on page 439).*

► Assign the date:

```
config:# time set date <yyyy-mm-dd>
```

► Assign the time:

```
config:# time set time <hh:mm:ss>
```

Variables:

Variable	Description
<yyyy-mm-dd>	Type the date in the format of yyyy-mm-dd. For example, type <i>2015-11-30</i> for November 30, 2015.
<hh:mm:ss>	Type the time in the format of hh:mm:ss in the 24-hour format. For example, type <i>13:50:20</i> for 1:50:20 pm.

Setting the Automatic Daylight Savings Time

This command determines whether the daylight savings time is applied to the time settings.

```
config:#    time autoDST <option>
```

Variables:

- <option> is one of the options: *enable* or *disable*.

Mode	Description
enable	Daylight savings time is enabled.
disable	Daylight savings time is disabled.

Examples

This section illustrates several time configuration examples.

Example 1 - Time Setup Method

The following command sets the date and time settings by using the NTP servers.

```
config:#    time method ntp
```

Example 2 - Primary NTP Server

The following command sets the primary time server to 192.168.80.66.

```
config:#    time ntp firstServer 192.168.80.66
```

Checking the Accessibility of NTP Servers

This command verifies the accessibility of NTP servers specified manually on your PX3 and then shows the result. For instructions on specifying NTP servers via CLI, see *Setting NTP Parameters* (on page 439).

To perform this command successfully, you must:

- Own the "Change Date/Time Settings" permission.
- Customize NTP servers. See *Setting NTP Parameters* (on page 439).
- Make the customized NTP servers override the DHCP-assigned ones. See *Overriding DHCP-Assigned NTP Servers* (on page 440).

This command is available either in the administrator/user mode or in the configuration mode. See *Different CLI Modes and Prompts* (on page 368).

► **In the administrator/user mode:**

```
#          check ntp
```

► **In the configuration mode:**

```
config#   check ntp
```

Security Configuration Commands

A security configuration command begins with *security*.

Firewall Control

You can manage firewall control features through the CLI. The firewall control lets you set up rules that permit or disallow access to the PX3 device from a specific or a range of IP addresses.

- An IPv4 firewall configuration command begins with *security ipAccessControl ipv4*.
- An IPv6 firewall configuration command begins with *security ipAccessControl ipv6*.

Modifying Firewall Control Parameters

There are different commands for modifying firewall control parameters.

- *IPv4 commands*

- ▶ **Enable or disable the IPv4 firewall control feature:**

```
config:# security ipAccessControl ipv4 enabled <option>
```

- ▶ **Determine the default IPv4 firewall control policy for inbound traffic:**

```
config:# security ipAccessControl ipv4 defaultPolicyIn <policy>
```

- ▶ **Determine the default IPv4 firewall control policy for outbound traffic:**

```
config:# security ipAccessControl ipv4 defaultPolicyOut <policy>
```

- *IPv6 commands*

- ▶ **Enable or disable the IPv6 firewall control feature:**

```
config:# security ipAccessControl ipv6 enabled <option>
```

- ▶ **Determine the default IPv6 firewall control policy for inbound traffic:**

```
config:# security ipAccessControl ipv6 defaultPolicyIn <policy>
```

- ▶ **Determine the default IPv6 firewall control policy for outbound traffic:**

```
config:# security ipAccessControl ipv6 defaultPolicyOut <policy>
```

Variables:

- <option> is one of the options: *true* or *false*.

Option	Description
true	Enables the IP access control feature.

Option	Description
false	Disables the IP access control feature.

- <policy> is one of the options: *accept*, *drop* or *reject*.

Option	Description
accept	Accepts traffic from all IP addresses.
drop	Discards traffic from all IP addresses, without sending any failure notification to the source host.
reject	Discards traffic from all IP addresses, and an ICMP message is sent to the source host for failure notification.

*Tip: You can combine both commands to modify all firewall control parameters at a time. See **Multi-Command Syntax** (on page 520).*

Managing Firewall Rules

You can add, delete or modify firewall rules using the CLI commands.

- An IPv4 firewall control rule command begins with *security ipAccessControl ipv4 rule*.
- An IPv6 firewall control rule command begins with *security ipAccessControl ipv6 rule*.

Adding a Firewall Rule

Depending on where you want to add a new firewall rule in the list, the command for adding a rule varies.

- *IPv4 commands*

▶ Add a new rule to the bottom of the IPv4 rules list:

```
config:# security ipAccessControl ipv4 rule add <direction> <ip_mask> <policy>
```

▶ Add a new IPv4 rule by inserting it above or below a specific rule:

```
config:# security ipAccessControl ipv4 rule add <direction> <ip_mask> <policy> <insert>
<rule_number>
```

-- OR --

```
config:# security ipAccessControl ipv4 rule add <direction> <insert> <rule_number>
<ip_mask> <policy>
```

- *IPv6 commands*

▶ **Add a new rule to the bottom of the IPv6 rules list:**

```
config:# security ipAccessControl ipv6 rule add <direction> <ip_mask> <policy>
```

▶ **Add a new IPv6 rule by inserting it above or below a specific rule:**

```
config:# security ipAccessControl ipv6 rule add <direction> <ip_mask> <policy> <insert>
<rule_number>
```

-- OR --

```
config:# security ipAccessControl ipv6 rule add <direction> <insert> <rule_number>
<ip_mask> <policy>
```

Variables:

- <direction> is one of the options: *in* or *out*.

Direction	Description
in	Inbound traffic.
out	Outbound traffic.

- <ip_mask> is the combination of the IP address and subnet mask values (or prefix length), which are separated with a slash. For example, an IPv4 combination looks like this: *192.168.94.222/24*.
- <policy> is one of the options: *accept*, *drop* or *reject*.

Policy	Description
accept	Accepts traffic from/to the specified IP address(es).
drop	Discards traffic from/to the specified IP address(es), without sending any failure notification to the source or destination host.
reject	Discards traffic from/to the specified IP address(es), and an ICMP message is sent to the source or destination host for failure notification.

- <insert> is one of the options: *insertAbove* or *insertBelow*.

Option	Description
insertAbove	Inserts the new rule above the specified rule number. Then: <i>new rule's number = the specified rule number</i>
insertBelow	Inserts the new rule below the specified rule number. Then: <i>new rule's number = the specified rule number + 1</i>

- <rule_number> is the number of the existing rule which you want to insert the new rule above or below.

Modifying a Firewall Rule

Depending on what to modify in an existing rule, the command varies.

- *IPv4 commands*

▶ **Modify an IPv4 rule's IP address and/or subnet mask:**

```
config:# security ipAccessControl ipv4 rule modify <direction> <rule_number> ipMask <ip_mask>
```

▶ **Modify an IPv4 rule's policy:**

```
config:# security ipAccessControl ipv4 rule modify <direction> <rule_number> policy <policy>
```

▶ **Modify all contents of an existing IPv4 rule:**

```
config:# security ipAccessControl ipv4 rule modify <direction> <rule_number> ipMask <ip_mask> policy <policy>
```

- *IPv6 commands*

▶ **Modify an IPv6 rule's IP address and/or prefix length:**

```
config:# security ipAccessControl ipv6 rule modify <direction> <rule_number> ipMask <ip_mask>
```

▶ **Modify an IPv6 rule's policy:**

```
config:# security ipAccessControl ipv6 rule modify <direction> <rule_number> policy
<policy>
```

► **Modify all contents of an IPv6 existing rule:**

```
config:# security ipAccessControl ipv6 rule modify <direction> <rule_number> ipMask
<ip_mask> policy <policy>
```

Variables:

- <direction> is one of the options: *in* or *out*.

Direction	Description
in	Inbound traffic.
out	Outbound traffic.

- <rule_number> is the number of the existing rule that you want to modify.
- <ip_mask> is the combination of the IP address and subnet mask values (or prefix length), which are separated with a slash. For example, an IPv4 combination looks like this: *192.168.94.222/24*.
- <policy> is one of the options: *accept*, *drop* or *reject*.

Option	Description
accept	Accepts traffic from/to the specified IP address(es).
drop	Discards traffic from/to the specified IP address(es), without sending any failure notification to the source or destination host.
reject	Discards traffic from/to the specified IP address(es), and an ICMP message is sent to the source or destination host for failure notification.

Deleting a Firewall Rule

The following commands remove a specific IPv4 or IPv6 rule from the list.

► **IPv4 commands**

```
config:# security ipAccessControl ipv4 rule delete <direction> <rule_number>
```

▶ IPv6 commands

```
config:# security ipAccessControl ipv6 rule delete <direction> <rule_number>
```

Variables:

- <direction> is one of the options: *in* or *out*.

Direction	Description
in	Inbound traffic.
out	Outbound traffic.

- <rule_number> is the number of the existing rule that you want to remove.

Restricted Service Agreement

The CLI command used to set the Restricted Service Agreement feature begins with `security restrictedServiceAgreement`,

Enabling or Disabling the Restricted Service Agreement

This command activates or deactivates the Restricted Service Agreement.

```
config:# security restrictedServiceAgreement enabled <option>
```

Variables:

- <option> is one of the options: *true* or *false*.

Option	Description
true	Enables the Restricted Service Agreement feature.
false	Disables the Restricted Service Agreement feature.

After the Restricted Service Agreement feature is enabled, the agreement's content is displayed in the login screen.

Do either of the following, or the login fails:

- In the web interface, select the checkbox labeled "I understand and accept the Restricted Service Agreement."

Tip: To select the agreement checkbox using the keyboard, first press Tab to go to the checkbox and then Enter.

- In the CLI, type `y` when the confirmation message "I understand and accept the Restricted Service Agreement" is displayed.

Specifying the Agreement Contents

This command allows you to create or modify contents of the Restricted Service Agreement.

```
config:# security restrictedServiceAgreement bannerContent
```

After performing the above command, do the following:

1. Type the text comprising up to 10,000 ASCII characters when the CLI prompts you to enter the content.
2. To end the content:
 - a. Press Enter.
 - b. Type `--END--` to indicate the end of the content.
 - c. Press Enter again.

If the content is successfully entered, the CLI displays this message "Successfully entered Restricted Service Agreement" followed by the total number of entered characters in parentheses.

*Note: The new content of Restricted Service Agreement is saved only after typing the `apply` command. See **Quitting Configuration Mode** (on page 404).*

Example

The following example illustrates how to specify the content of the Restricted Service Agreement.

1. Type the following command and press Enter to start entering the content.

```
config:# security restrictedServiceAgreement bannerContent
```

2. Type the following content when the CLI prompts you to enter the content.

IMPORTANT!! You are accessing a PDU. If you are not the system administrator, do NOT power off or power cycle any outlet without the permission of the system administrator.

3. Press Enter.
4. Type the following:
--END--
5. Press Enter again.
6. Verify that the message "Successfully entered Restricted Service Agreement" is displayed, indicating that the content input is successful.

Login Limitation

The login limitation feature controls login-related limitations, such as password aging, simultaneous logins using the same user name, and the idle time permitted before forcing a user to log out.

A login limitation command begins with *security loginLimits*.

You can combine multiple commands to modify various login limitation parameters at a time. See **Multi-Command Syntax** (on page 520).

Single Login Limitation

This command enables or disables the single login feature, which controls whether multiple logins using the same login name simultaneously is permitted.

```
config:# security loginLimits singleLogin <option>
```

Variables:

- <option> is one of the options: *enable* or *disable*.

Option	Description
enable	Enables the single login feature.
disable	Disables the single login feature.

Password Aging

This command enables or disables the password aging feature, which controls whether the password should be changed at a regular interval:

```
config:# security loginLimits passwordAging <option>
```

Variables:

- <option> is one of the options: *enable* or *disable*.

Option	Description
enable	Enables the password aging feature.
disable	Disables the password aging feature.

Password Aging Interval

This command determines how often the password should be changed.

```
config:# security loginLimits passwordAgingInterval <value>
```

Variables:

- <value> is a numeric value in days set for the password aging interval. The interval ranges from 7 to 365 days.

Idle Timeout

This command determines how long a user can remain idle before that user is forced to log out of the PX3 web interface or CLI.

```
config:# security loginLimits idleTimeout <value>
```

Variables:

- <value> is a numeric value in minutes set for the idle timeout. The timeout ranges from 1 to 1440 minutes (24 hours).

User Blocking

There are different commands for changing different user blocking parameters. These commands begin with `security userBlocking`.

You can combine multiple commands to modify the user blocking parameters at a time. See *Multi-Command Syntax* (on page 520).

- ▶ **Determine the maximum number of failed logins before blocking a user:**

```
config:# security userBlocking maximumNumberOfFailedLogins <value1>
```

- ▶ **Determine how long a user is blocked:**

```
config:# security userBlocking blockTime <value2>
```

Variables:

- <value1> is an integer between 3 and 10, or *unlimited*, which sets no limit on the maximum number of failed logins and thus disables the user blocking function.
- <value2> is a numeric value ranging from 1 to 1440 minutes (one day), or *infinite*, which blocks the user all the time until the user is unblocked manually.

Strong Passwords

The strong password commands determine whether a strong password is required for login, and what a strong password should contain at least.

A strong password command begins with `security strongPasswords`.

You can combine multiple strong password commands to modify different parameters at a time. See *Multi-Command Syntax* (on page 520).

Enabling or Disabling Strong Passwords

This command enables or disables the strong password feature.

```
config:# security strongPasswords enabled <option>
```

Variables:

- <option> is one of the options: *true* or *false*.

Option	Description
true	Enables the strong password feature.
false	Disables the strong password feature.

Minimum Password Length

This command determines the minimum length of the password.

```
config:# security strongPasswords minLength <value>
```

Variables:

- <value> is an integer between 8 and 32.

Maximum Password Length

This command determines the maximum length of the password.

```
config:# security strongPasswords maxLength <value>
```

Variables:

- <value> is an integer between 16 and 64.

Lowercase Character Requirement

This command determines whether a strong password includes at least a lowercase character.

```
config:# security strongPasswords enforceAtLeastOneLowerCaseCharacter <option>
```

Variables:

- <option> is one of the options: *enable* or *disable*.

Option	Description
enable	At least one lowercase character is required.

Option	Description
disable	No lowercase character is required.

Uppercase Character Requirement

This command determines whether a strong password includes at least a uppercase character.

```
config:# security strongPasswords enforceAtLeastOneUpperCaseCharacter <option>
```

Variables:

- <option> is one of the options: *enable* or *disable*.

Option	Description
enable	At least one uppercase character is required.
disable	No uppercase character is required.

Numeric Character Requirement

This command determines whether a strong password includes at least a numeric character.

```
config:# security strongPasswords enforceAtLeastOneNumericCharacter <option>
```

Variables:

- <option> is one of the options: *enable* or *disable*.

Option	Description
enable	At least one numeric character is required.
disable	No numeric character is required.

Special Character Requirement

This command determines whether a strong password includes at least a special character.

```
config:# security strongPasswords enforceAtLeastOneSpecialCharacter <option>
```

Variables:

- <option> is one of the options: *enable* or *disable*.

Option	Description
enable	At least one special character is required.
disable	No special character is required.

Maximum Password History

This command determines the number of previous passwords that CANNOT be repeated when changing the password.

```
config:# security strongPasswords passwordHistoryDepth <value>
```

Variables:

- <value> is an integer between 1 and 12.

Role-Based Access Control

In addition to firewall access control based on IP addresses, you can configure other access control rules that are based on both IP addresses and users' roles.

- An IPv4 role-based access control command begins with *security roleBasedAccessControl ipv4*.
- An IPv6 role-based access control command begins with *security roleBasedAccessControl ipv6*.

Modifying Role-Based Access Control Parameters

There are different commands for modifying role-based access control parameters.

- *IPv4 commands*

▶ **Enable or disable the IPv4 role-based access control feature:**

```
config:# security roleBasedAccessControl ipv4 enabled <option>
```

▶ **Determine the IPv4 role-based access control policy:**

```
config:# security roleBasedAccessControl ipv4 defaultPolicy <policy>
```

- *IPv6 commands*

- ▶ **Enable or disable the IPv6 role-based access control feature:**

```
config:# security roleBasedAccessControl ipv6 enabled <option>
```

- ▶ **Determine the IPv6 role-based access control policy:**

```
config:# security roleBasedAccessControl ipv6 defaultPolicy <policy>
```

Variables:

- <option> is one of the options: *true* or *false*.

Option	Description
true	Enables the role-based access control feature.
false	Disables the role-based access control feature.

- <policy> is one of the options: *allow* or *deny*.

Policy	Description
allow	Accepts traffic from all IP addresses regardless of the user's role.
deny	Drops traffic from all IP addresses regardless of the user's role.

*Tip: You can combine both commands to modify all role-based access control parameters at a time. See **Multi-Command Syntax** (on page 520).*

Managing Role-Based Access Control Rules

You can add, delete or modify role-based access control rules.

- An IPv4 role-based access control command for managing rules begins with *security roleBasedAccessControl ipv4 rule*.
- An IPv6 role-based access control command for managing rules begins with *security roleBasedAccessControl ipv6 rule*.

Adding a Role-Based Access Control Rule

Depending on where you want to add a new rule in the list, the command syntax for adding a rule varies.

- *IPv4 commands*

▶ **Add a new rule to the bottom of the IPv4 rules list:**

```
config:# security roleBasedAccessControl ipv4 rule add <start_ip> <end_ip> <role>
<policy>
```

▶ **Add a new IPv4 rule by inserting it above or below a specific rule:**

```
config:# security roleBasedAccessControl ipv4 rule add <start_ip> <end_ip> <role>
<policy> <insert> <rule_number>
```

- *IPv6 commands*

▶ **Add a new rule to the bottom of the IPv6 rules list:**

```
config:# security roleBasedAccessControl ipv6 rule add <start_ip> <end_ip> <role>
<policy>
```

▶ **Add a new IPv6 rule by inserting it above or below a specific rule:**

```
config:# security roleBasedAccessControl ipv6 rule add <start_ip> <end_ip> <role>
<policy> <insert> <rule_number>
```

Variables:

- <start_ip> is the starting IP address.
- <end_ip> is the ending IP address.
- <role> is the role for which you want to create an access control rule.
- <policy> is one of the options: *allow* or *deny*.

Policy	Description
allow	Accepts traffic from the specified IP address range when the user is a member of the specified role
deny	Drops traffic from the specified IP address range when the user is a member of the specified role

- <insert> is one of the options: *insertAbove* or *insertBelow*.

Option	Description
insertAbove	Inserts the new rule above the specified rule number. Then: <i>new rule's number = the specified rule number</i>
insertBelow	Inserts the new rule below the specified rule number. Then: <i>new rule's number = the specified rule number + 1</i>

- <rule_number> is the number of the existing rule which you want to insert the new rule above or below.

Modifying a Role-Based Access Control Rule

Depending on what to modify in an existing rule, the command syntax varies.

- *IPv4 commands*

▶ Modify a rule's IPv4 address range:

```
config:# security roleBasedAccessControl ipv4 rule modify <rule_number>
startIpAddress <start_ip> endIpAddress <end_ip>
```

▶ Modify an IPv4 rule's role:

```
config:# security roleBasedAccessControl ipv4 rule modify <rule_number> role <role>
```

▶ Modify an IPv4 rule's policy:

```
config:# security roleBasedAccessControl ipv4 rule modify <rule_number> policy
<policy>
```

▶ Modify all contents of an existing IPv4 rule:

```
config:# security roleBasedAccessControl ipv4 rule modify <rule_number>
startIpAddress <start_ip> endIpAddress <end_ip> role <role> policy <policy>
```

- *IPv6 commands*

▶ Modify a rule's IPv6 address range:

```
config:# security roleBasedAccessControl ipv6 rule modify <rule_number>
startIpAddress <start_ip> endIpAddress <end_ip>
```

► **Modify an IPv6 rule's role:**

```
config:# security roleBasedAccessControl ipv6 rule modify <rule_number> role <role>
```

► **Modify an IPv6 rule's policy:**

```
config:# security roleBasedAccessControl ipv6 rule modify <rule_number> policy
<policy>
```

► **Modify all contents of an existing IPv6 rule:**

```
config:# security roleBasedAccessControl ipv6 rule modify <rule_number>
startIpAddress <start_ip> endIpAddress <end_ip> role <role> policy <policy>
```

Variables:

- <rule_number> is the number of the existing rule that you want to modify.
- <start_ip> is the starting IP address.
- <end_ip> is the ending IP address.
- <role> is one of the existing roles.
- <policy> is one of the options: *allow* or *deny*.

Policy	Description
allow	Accepts traffic from the specified IP address range when the user is a member of the specified role
deny	Drops traffic from the specified IP address range when the user is a member of the specified role

Deleting a Role-Based Access Control Rule

These commands remove a specific rule from the list.

► **IPv4 commands**

```
config:# security roleBasedAccessControl ipv4 rule delete <rule_number>
```

▶ IPv6 commands

```
config:# security roleBasedAccessControl ipv6 rule delete <rule_number>
```

Variables:

- <rule_number> is the number of the existing rule that you want to remove.

Enabling or Disabling Front Panel Outlet Switching

This section applies to outlet-switching capable models only.

The following CLI commands control whether you can turn on or off an outlet by operating the front panel display.

▶ **To enable the front panel outlet control feature:**

```
config:# security frontPanelPermissions add switchOutlet
```

▶ **To disable the front panel outlet control feature:**

```
config:# security frontPanelPermissions remove switchOutlet
```

Enabling or Disabling Front Panel Actuator Control

The following CLI commands control whether you can turn on or off a connected actuator by operating the front panel LCD display.

► **To enable the front panel actuator control feature:**

```
config:# security frontPanelPermissions add switchActuator
```

► **To disable the front panel actuator control feature:**

```
config:# security frontPanelPermissions remove switchActuator
```

Tip: If your PDU supports multiple front panel permissions, you can combine them into one command by adding a semicolon (;) between different permissions. For example, the following CLI command enables both front panel actuator control and outlet switching functions simultaneously.

```
security frontPanelPermissions add
switchActuator;switchOutlet
```

Examples

This section illustrates several security configuration examples.

Example 1 - IPv4 Firewall Control Configuration

The following command sets up two parameters of the IPv4 access control feature.

```
config:# security ipAccessControl ipv4 enabled true defaultPolicyIn accept
defaultPolicyOut accept
```

Results:

- The IPv4 access control feature is enabled.
- The default policy for inbound traffic is set to "accept."
- The default policy for outbound traffic is set to "accept."

Example 2 - Adding an IPv4 Firewall Rule

The following command adds a new IPv4 access control rule and specifies its location in the list.

```
config:# security ipAccessControl ipv4 rule add 192.168.84.123/24 accept
insertAbove 5
```

Results:

- A new IPv4 firewall control rule is added to accept all packets sent from the IPv4 address 192.168.84.123.
- The newly-added rule is inserted above the 5th rule. That is, the new rule becomes the 5th rule, and the original 5th rule becomes the 6th rule.

Example 3 - User Blocking

The following command sets up two user blocking parameters.

```
config:# security userBlocking maximumNumberOfFailedLogins 5 blockTime 30
```

Results:

- The maximum number of failed logins is set to 5.
- The user blocking time is set to 30 minutes.

Example 4 - Adding an IPv4 Role-based Access Control Rule

The following command creates a new IPv4 role-based access control rule and specifies its location in the list.

```
config:# security roleBasedAccessControl ipv4 rule add 192.168.78.50 192.168.90.100
admin deny insertAbove 3
```

Results:

- A new IPv4 role-based access control rule is added, dropping all packets from any IPv4 address between 192.168.78.50 and 192.168.90.100 when the user is a member of the role "admin."
- The newly-added IPv4 rule is inserted above the 3rd rule. That is, the new rule becomes the 3rd rule, and the original 3rd rule becomes the 4th rule.

Outlet Configuration Commands

An outlet configuration command begins with *outlet*. Such a command allows you to configure an individual outlet.

Changing the Outlet Name

This command names an outlet.

```
config:# outlet <n> name "<name>"
```

Variables:

- <n> is the number of the outlet that you want to configure.
- <name> is a string comprising up to 32 ASCII printable characters. The <name> variable must be enclosed in quotes when it contains spaces.

Changing an Outlet's Default State

This section applies to outlet-switching capable models only.

This command determines the initial power condition of an outlet after the PX3 powers up.

```
config:# outlet <n> stateOnDeviceStartup <option>
```

Variables:

- <n> is the number of the outlet that you want to configure.
- <option> is one of the options: *off*, *on*, *lastKnownState* and *pduDefined*.

Option	Description
off	Turn off the outlet.
on	Turn on the outlet.
lastKnownState	Restore the outlet to the state prior to last PDU power down.
pduDefined	PDU-defined setting.

*Note: Setting the outlet's default state to an option other than pduDefined overrides the PDU-defined default state on that outlet. See **Setting the PDU-Defined Default Outlet State** (on page 406).*

Setting an Outlet's Cycling Power-Off Period

This section applies to outlet-switching capable models only.

This command determines the power-off period of the power cycling operation for a specific outlet.

```
config:# outlet <n> cyclingPowerOffPeriod <timing>
```

Variables:

- <n> is the number of the outlet that you want to configure.
- <timing> is the time of the cycling power-off period in seconds, which is an integer between 0 and 3600, or pduDefined for following the PDU-defined timing.

*Note: This setting overrides the PDU-defined cycling power-off period on a particular outlet. See **Setting the PDU-Defined Cycling Power-Off Period** (on page 407).*

Example - Outlet Naming

The following command assigns the name "Win XP" to outlet 8.

```
config:# outlet 8 name "Win XP"
```

Inlet Configuration Commands

An inlet configuration command begins with *inlet*. You can configure an inlet by using the inlet configuration command.

Changing the Inlet Name

This command syntax names an inlet.

```
config:#  inlet <n> name "<name>"
```

Variables:

- <n> is the number of the inlet that you want to configure. For a single-inlet PDU, <n> is always the number 1. The value is an integer between 1 and 50.
- <name> is a string comprising up to 32 ASCII printable characters. The <name> variable must be enclosed in quotes when it contains spaces.

Enabling or Disabling an Inlet (for Multi-Inlet PDUs)

Enabling or disabling an inlet takes effect on a multi-inlet PDU only.

This command enables or disables an inlet.

```
config:#  inlet <n> enabled <option>
```

Variables:

- <n> is the number of the inlet that you want to configure. For a single-inlet PDU, <n> is always the number 1. The value is an integer between 1 and 50.
- <option> is one of the options: *true* or *false*.

Option	Description
true	The specified inlet is enabled.
false	The specified inlet is disabled.

Note: If performing this command causes all inlets to be disabled, a warning message appears, prompting you to confirm. When this occurs, press y to confirm or n to cancel the operation.

Example - Inlet Naming

The following command assigns the name "AC source" to the inlet 1. If your PX3 device contains multiple inlets, this command names the 1st inlet.

```
config:#    inlet 1 name "AC source"
```

Overcurrent Protector Configuration Commands

An overcurrent protector configuration command begins with *ocp*. The command configures an individual circuit breaker or fuse which protects outlets.

Changing the Overcurrent Protector Name

This command names a circuit breaker or a fuse which protects outlets on your PX3.

```
config:#    ocp <n> name "<name>"
```

Variables:

- <n> is the number of the overcurrent protector that you want to configure. The value is an integer between 1 and 50.
- <name> is a string comprising up to 32 ASCII printable characters. The <name> variable must be enclosed in quotes when it contains spaces.

Example - OCP Naming

The command assigns the name "Email servers CB" to the overcurrent protector labeled 2.

```
config:#    ocp 2 name "Email servers CB"
```

User Configuration Commands

Most user configuration commands begin with *user* except for the password change command.

Creating a User Profile

This command creates a new user profile.

```
config:# user create <name> <option> <roles>
```

After performing the user creation command, the PX3 prompts you to assign a password to the newly-created user. Then:

1. Type the password and press Enter.
2. Re-type the same password for confirmation and press Enter.

Variables:

- <name> is a string comprising up to 32 ASCII printable characters. The <name> variable CANNOT contain spaces.
- <option> is one of the options: *enable* or *disable*.

Option	Description
enable	Enables the newly-created user profile.
disable	Disables the newly-created user profile.

- <roles> is a role or a list of comma-separated roles assigned to the specified user profile.

Modifying a User Profile

A user profile contains various parameters that you can modify.

*Tip: You can combine all commands to modify the parameters of a specific user profile at a time. See **Multi-Command Syntax** (on page 520).*

Changing a User's Password

This command allows you to change an existing user's password if you have the Administrator Privileges.

```
config:# user modify <name> password
```

After performing the above command, PX3 prompts you to enter a new password. Then:

1. Type a new password and press Enter.

2. Re-type the new password for confirmation and press Enter.

Variables:

- <name> is the name of the user whose settings you want to change.

Example

The following procedure illustrates how to change the password of the user "May."

1. Verify that you have entered the configuration mode. See *Entering Configuration Mode* (on page 403).
2. Type the following command to change the password for the user profile "May."

```
config:# user modify May password
```
3. Type a new password when prompted, and press Enter.
4. Type the same new password and press Enter.
5. If the password change is completed successfully, the config:# prompt appears.

Modifying a User's Personal Data

You can change a user's personal data, including the user's full name, telephone number, and email address.

Various commands can be combined to modify the parameters of a specific user profile at a time. See **Multi-Command Syntax** (on page 520).

▶ Change a user's full name:

```
config:# user modify <name> fullName "<full_name>"
```

▶ Change a user's telephone number:

```
config:# user modify <name> telephoneNumber "<phone_number>"
```

▶ Change a user's email address:

```
config:# user modify <name> emailAddress <email_address>
```

Variables:

- <name> is the name of the user whose settings you want to change.
- <full_name> is a string comprising up to 32 ASCII printable characters. The <full_name> variable must be enclosed in quotes when it contains spaces.
- <phone_number> is the phone number that can reach the specified user. The <phone_number> variable must be enclosed in quotes when it contains spaces.
- <email_address> is the email address of the specified user.

Enabling or Disabling a User Profile

This command enables or disables a user profile. A user can log in to the PX3 device only after that user's user profile is enabled.

```
config:# user modify <name> enabled <option>
```

Variables:

- <name> is the name of the user whose settings you want to change.
- <option> is one of the options: *true* or *false*.

Option	Description
true	Enables the specified user profile.
false	Disables the specified user profile.

Forcing a Password Change

This command determines whether the password change is forced when a user logs in to the specified user profile next time.

```
config:# user modify <name> forcePasswordChangeOnNextLogin <option>
```

Variables:

- <name> is the name of the user whose settings you want to change.
- <option> is one of the options: *true* or *false*.

Option	Description
true	A password change is forced on the user's next login.
false	No password change is forced on the user's next login.

Modifying SNMPv3 Settings

There are different commands to modify the SNMPv3 parameters of a specific user profile. You can combine all of the following commands to modify the SNMPv3 parameters at a time. See **Multi-Command Syntax** (on page 520).

- ▶ **Enable or disable the SNMP v3 access to PX3 for the specified user:**

```
config:# user modify <name> snmpV3Access <option1>
```

Variables:

- <name> is the name of the user whose settings you want to change.
- <option1> is one of the options: *enable* or *disable*.

Option	Description
enable	Enables the SNMP v3 access permission for the specified user.
disable	Disables the SNMP v3 access permission for the specified user.

- ▶ **Determine the security level:**

```
config:# user modify <name> securityLevel <option2>
```

Variables:

- <name> is the name of the user whose settings you want to change.
- <option2> is one of the options: *noAuthNoPriv*, *authNoPriv* or *authPriv*.

Option	Description
noAuthNoPriv	No authentication and no privacy.
authNoPriv	Authentication and no privacy.
authPriv	Authentication and privacy.

- ▶ **Determine whether the authentication passphrase is identical to the password:**

```
config:# user modify <name> userPasswordAsAuthenticationPassphrase <option3>
```

Variables:

- <name> is the name of the user whose settings you want to change.
- <option3> is one of the options: *true* or *false*.

Option	Description
true	Authentication passphrase is identical to the password.
false	Authentication passphrase is different from the password.

► **Determine the authentication passphrase:**

```
config:# user modify <name> authenticationPassPhrase <authentication_passphrase>
```

Variables:

- <name> is the name of the user whose settings you want to change.
- <authentication_passphrase> is a string used as an authentication passphrase, comprising 8 to 32 ASCII printable characters.

► **Determine whether the privacy passphrase is identical to the authentication passphrase:**

```
config:# user modify <name> useAuthenticationPassPhraseAsPrivacyPassPhrase <option4>
```

Variables:

- <name> is the name of the user whose settings you want to change.
- <option4> is one of the options: *true* or *false*.

Option	Description
true	Privacy passphrase is identical to the authentication passphrase.
false	Privacy passphrase is different from the authentication passphrase.

► **Determine the privacy passphrase:**

```
config:# user modify <name> privacyPassPhrase <privacy_passphrase>
```

Variables:

- <name> is the name of the user whose settings you want to change.
- <privacy_passphrase> is a string used as a privacy passphrase, comprising 8 to 32 ASCII printable characters.

► **Determine the authentication protocol:**

```
config:# user modify <name> authenticationProtocol <option5>
```

Variables:

- <name> is the name of the user whose settings you want to change.
- <option5> is one of the options: *MD5* or *SHA-1*.

Option	Description
MD5	MD5 authentication protocol is applied.
SHA-1	SHA-1 authentication protocol is applied.

► **Determine the privacy protocol:**

```
config:# user modify <name> privacyProtocol <option6>
```

Variables:

- <name> is the name of the user whose settings you want to change.
- <option6> is one of the options: *DES* or *AES-128*.

Option	Description
DES	DES privacy protocol is applied.
AES-128	AES-128 privacy protocol is applied.

Changing the Role(s)

This command changes the role(s) of a specific user.

```
config:# user modify <name> roles <roles>
```

Variables:

- <name> is the name of the user whose settings you want to change.
- <roles> is a role or a list of comma-separated roles assigned to the specified user profile. See **All Privileges** (on page 481).

Changing Measurement Units

You can change the measurement units displayed for temperatures, length, and pressure for a specific user profile. Different measurement unit commands can be combined so that you can set all measurement units at a time. To combine all commands, see **Multi-Command Syntax** (on page 520).

Note: The measurement unit change only applies to the web interface and command line interface.

*Tip: To set the default measurement units applied to the PX3 user interfaces for all users via CLI, see **Setting Default Measurement Units** (on page 478).*

► **Set the preferred temperature unit:**

```
config:# user modify <name> preferredTemperatureUnit <option1>
```

Variables:

- <name> is the name of the user whose settings you want to change.
- <option1> is one of the options: *C* or *F*.

Option	Description
C	This option displays the temperature in Celsius.
F	This option displays the temperature in Fahrenheit.

► **Set the preferred length unit:**

```
config:# user modify <name> preferredLengthUnit <option2>
```

Variables:

- <name> is the name of the user whose settings you want to change.
- <option2> is one of the options: *meter* or *feet*.

Option	Description
meter	This option displays the length or height in meters.
feet	This option displays the length or height in feet.

► **Set the preferred pressure unit:**

```
config:# user modify <name> preferredPressureUnit <option3>
```

Variables:

- <name> is the name of the user whose settings you want to change.
- <option3> is one of the options: *pascal* or *psi*.

Option	Description
pascal	This option displays the pressure value in Pascals (Pa).
psi	This option displays the pressure value in psi.

Specifying the SSH Public Key

If the SSH key-based authentication is enabled, specify the SSH public key for each user profile using the following procedure.

► **To specify or change the SSH public key for a specific user:**

1. Type the SSH public key command as shown below and press Enter.

```
config:# user modify <name> sshPublicKey
```
2. The system prompts you to enter the contents of the SSH public key. Do the following to input the contents:
 - a. Open your SSH public key with a text editor.
 - b. Copy all contents in the text editor.
 - c. Paste the contents into the terminal.

d. Press Enter.

► **To remove an existing SSH public key:**

1. Type the same command as shown above.
2. When the system prompts you to input the contents, press Enter without typing or pasting anything.

Example

The following procedure illustrates how to change the SSH public key for the user "assistant."

1. Verify that you have entered the configuration mode. See *Entering Configuration Mode* (on page 403).
2. Type the following command and press Enter.

```
config:# user modify assistant sshPublicKey
```
3. You are prompted to enter a new SSH public key.
4. Type the new key and press Enter.

Deleting a User Profile

This command deletes an existing user profile.

```
config:# user delete <name>
```

Changing Your Own Password

Every user can change their own password via this command if they have the Change Own Password privilege. Note that this command does not begin with *user*.

```
config:# password
```

After performing this command, the PX3 prompts you to enter both current and new passwords respectively.

Important: After the password is changed successfully, the new password is effective immediately no matter you type the command "apply" or not to save the changes.

Example

This procedure changes your own password:

1. Verify that you have entered the configuration mode. See *Entering Configuration Mode* (on page 403).
2. Type the following command and press Enter.

```
config:# password
```

3. Type the existing password and press Enter when the following prompt appears.
Current password:
4. Type the new password and press Enter when the following prompt appears.
Enter new password:
5. Re-type the new password for confirmation and press Enter when the following prompt appears.
Re-type new password:

Setting Default Measurement Units

Default measurement units, including temperature, length, and pressure units, apply to the PX3 user interfaces across all users except for those whose preferred measurement units are set differently by themselves or the administrator. Diverse measurement unit commands can be combined so that you can set all default measurement units at a time. To combine all commands, see *Multi-Command Syntax* (on page 520).

Note: The measurement unit change only applies to the web interface and command line interface.

*Tip: To change the preferred measurement units displayed in the PX3 user interfaces for a specific user via CLI, see **Changing Measurement Units** (on page 475).*

► Set the default temperature unit:

```
config:# user defaultpreferences preferredTemperatureUnit <option1>
```

Variables:

- <option1> is one of the options: *C* or *F*.

Option	Description
C	This option displays the temperature in Celsius.
F	This option displays the temperature in Fahrenheit.

► Set the default length unit:

```
config:# user defaultpreferences preferredLengthUnit <option2>
```

Variables:

- <option2> is one of the options: *meter* or *feet*.

Option	Description
meter	This option displays the length or height in meters.
feet	This option displays the length or height in feet.

► **Set the default pressure unit:**

```
config:# user defaultpreferences preferredPressureUnit <option3>
```

Variables:

- <option3> is one of the options: *pascal* or *psi*.

Option	Description
pascal	This option displays the pressure value in Pascals (Pa).
psi	This option displays the pressure value in psi.

Examples

This section illustrates several user configuration examples.

Example 1 - Creating a User Profile

The following command creates a new user profile and sets two parameters for the new user.

```
config:# user create May enable admin
```

Results:

- A new user profile "May" is created.
- The new user profile is enabled.
- The **admin** role is assigned to the new user profile.

Example 2 - Modifying a User's Roles

The following command assigns two roles to the user "May."

```
config:# user modify May roles admin,tester
```

Results:

- The user May has the union of all privileges of "admin" and "tester."

Example 3 - Default Measurement Units

The following command sets all default measurement units at a time.

```
config:# user defaultpreferences preferredTemperatureUnit F preferredLengthUnit feet
preferredPressureUnit psi
```

Results:

- The default temperature unit is set to Fahrenheit.
- The default length unit is set to feet.
- The default pressure unit is set to psi.

Role Configuration Commands

A role configuration command begins with *role*.

Creating a Role

This command creates a new role, with a list of semicolon-separated privileges assigned to the role.

```
config:# role create <name> <privilege1>;<privilege2>;<privilege3>...
```

If a specific privilege contains any arguments, that privilege should be followed by a colon and the argument(s).

```
config:# role create <name> <privilege1>:<argument1>,<argument2>...;
<privilege2>:<argument1>,<argument2>...;
<privilege3>:<argument1>,<argument2>...;
...
```

Variables:

- <name> is a string comprising up to 32 ASCII printable characters.
- <privilege1>, <privilege2>, <privilege3> and the like are names of the privileges assigned to the role. Separate each privilege with a semi-colon. See **All Privileges** (on page 481).
- <argument1>, <argument2> and the like are arguments set for a particular privilege. Separate a privilege and its argument(s) with a colon, and separate arguments with a comma if there are more than one argument for a privilege.

All Privileges

This table lists all privileges. Note that available privileges vary according to the model you purchased. For example, a PDU without the outlet switching function does not have the privilege "switchOutlet."

Privilege	Description
acknowledgeAlarms	Acknowledge Alarms
adminPrivilege	Administrator Privileges
changeAssetStripConfiguration	Change Asset Strip Configuration

Privilege	Description
changeAuthSettings	Change Authentication Settings
changeDateTimeSettings	Change Date/Time Settings
changeExternalSensorsConfiguration	Change Peripheral Device Configuration
changeLhxConfiguration	Change LHX/SHX Configuration
changeModemConfiguration	Change Modem Configuration
changeNetworkSettings	Change Network Settings
changePassword	Change Own Password
changePduConfiguration	Change Pdu, Inlet, Outlet & Overcurrent Protector Configuration
changeSecuritySettings	Change Security Settings
changeSnmpSettings	Change SNMP Settings
changeUserSettings	Change Local User Management
changeWebcamSettings	Change Webcam Configuration
clearLog	Clear Local Event Log
firmwareUpdate	Firmware Update
performReset	Reset (Warm Start)
switchOutlet*	Switch Outlet
switchActuator**	Switch Actuator
switchTransferSwitch	Switch Transfer Switch
viewEventSetup	View Event Settings
viewEverything	Unrestricted View Privileges
viewLog	View Local Event Log
viewSecuritySettings	View Security Settings
viewSnmpSettings	View SNMP Settings
viewUserSettings	View Local User Management
viewWebcamSettings	View Webcam Snapshots and Configuration

* The "switchOutlet" privilege requires an argument that is separated with a colon. The argument could be:

- All outlets, that is,
switchOutlet:all
- An outlet number. For example:
switchOutlet:1
switchOutlet:2
switchOutlet:3
- A list of comma-separated outlets. For example:
switchOutlet:1,3,5,7,8,9

** The "switchActuator" privilege requires an argument that is separated with a colon. The argument could be:

- All actuators, that is,
switchActuator:all
- An actuator's ID number. For example:
switchActuator:1
switchActuator:2
switchActuator:3
- A list of comma-separated ID numbers of different actuators. For example:
switchActuator:1,3,6

Note: The ID number of each actuator is shown in the PX3 web interface. It is an integer between 1 and 32.

Modifying a Role

You can modify diverse parameters of an existing role, including its privileges.

► **Modify a role's description:**

```
config:#    role modify <name> description "<description>"
```

Variables:

- <name> is a string comprising up to 32 ASCII printable characters.
- <description> is a description comprising alphanumeric characters. The <description> variable must be enclosed in quotes when it contains spaces.

► **Add more privileges to a specific role:**

```
config:#    role modify <name> addPrivileges  
            <privilege1>;<privilege2>;<privilege3>...
```

If a specific privilege contains any arguments, add a colon and the argument(s) after that privilege.

```
config:#  role modify <name> addPrivileges
          <privilege1>:<argument1>,<argument2>...;
          <privilege2>:<argument1>,<argument2>...;
          <privilege3>:<argument1>,<argument2>...;
          ...
```

Variables:

- <name> is a string comprising up to 32 ASCII printable characters.
- <privilege1>, <privilege2>, <privilege3> and the like are names of the privileges assigned to the role. Separate each privilege with a semi-colon. See **All Privileges** (on page 481).
- <argument1>, <argument2> and the like are arguments set for a particular privilege. Separate a privilege and its argument(s) with a colon, and separate arguments with a comma if there are more than one argument for a privilege.

▶ **Remove specific privileges from a role:**

```
config:#  role modify <name> removePrivileges
          <privilege1>;<privilege2>;<privilege3>...
```

If a specific privilege contains any arguments, add a colon and the argument(s) after that privilege.

```
config:#  role modify <name> removePrivileges
          <privilege1>:<argument1>,<argument2>...;
          <privilege2>:<argument1>,<argument2>...;
          <privilege3>:<argument1>,<argument2>...;
          ...
```

Note: When removing privileges from a role, make sure the specified privileges and arguments (if any) exactly match those assigned to the role. Otherwise, the command fails to remove specified privileges that are not available.

Variables:

- <name> is a string comprising up to 32 ASCII printable characters.
- <privilege1>, <privilege2>, <privilege3> and the like are names of the privileges assigned to the role. Separate each privilege with a semi-colon. See **All Privileges** (on page 481).
- <argument1>, <argument2> and the like are arguments set for a particular privilege. Separate a privilege and its argument(s) with a colon, and separate arguments with a comma if there are more than one argument for a privilege.

Deleting a Role

This command deletes an existing role.

```
config:#   role delete <name>
```

Example - Creating a Role

The following command creates a new role and assigns privileges to the role.

```
config:#   role create tester firmwareUpdate;viewEventSetup
```

Results:

- A new role "tester" is created.
- Two privileges are assigned to the role: firmwareUpdate (Firmware Update) and viewEventSetup (View Event Settings).

Environmental Sensor Configuration Commands

An environmental sensor configuration command begins with *externalsensor*. You can configure the name and location parameters of an individual environmental sensor.

*Note: To configure an actuator, see **Actuator Configuration Commands** (on page 504).*

Changing the Sensor Name

This command names an environmental sensor.

```
config:# externalsensor <n> name "<name>"
```

Variables:

- <n> is the ID number of the environmental sensor that you want to configure. The ID number is available in the PX3 web interface or using the command "show externalsensors <n>" in the CLI. It is an integer between 1 and 32.
- <name> is a string comprising up to 32 ASCII printable characters. The <name> variable must be enclosed in quotes when it contains spaces.

*Note: To name an actuator, see **Actuator Configuration Commands** (on page 504).*

Specifying the CC Sensor Type

Raritan's contact closure sensor (DPX-CC2-TR) supports the connection of diverse third-party or Raritan's detectors/switches. You must specify the type of connected detector/switch for proper operation. Use this command when you need to specify the sensor type.

```
config:# externalsensor <n> sensorSubType <sensor_type>
```

Variables:

- <n> is the ID number of the environmental sensor that you want to configure. The ID number is available in the PX3 web interface or using the command "show externalsensors <n>" in the CLI. It is an integer between 1 and 32.
- <sensor_type> is one of these types: *contact*, *smokeDetection*, *waterDetection* or *vibration*.

Type	Description
contact	The connected detector/switch is for detection of door lock or door closed/open status.
smokeDetection	The connected detector/switch is for detection of the smoke presence.
waterDetection	The connected detector/switch is for detection of the water presence.

Type	Description
vibration	The connected detector/switch is for detection of the vibration.

Setting the X Coordinate

This command specifies the X coordinate of an environmental sensor.

```
config:#  externalsensor <n> xlabel "<coordinate>"
```

Variables:

- <n> is the ID number of the environmental sensor that you want to configure. The ID number is available in the PX3 web interface or using the command "show externalsensors <n>" in the CLI. It is an integer between 1 and 32.
- <coordinate> is a string comprising up to 24 ASCII printable characters, and it must be enclosed in quotes.

Setting the Y Coordinate

This command specifies the Y coordinate of an environmental sensor.

```
config:#  externalsensor <n> ylabel "<coordinate>"
```

Variables:

- <n> is the ID number of the environmental sensor that you want to configure. The ID number is available in the PX3 web interface or using the command "show externalsensors <n>" in the CLI. It is an integer between 1 and 32.
- <coordinate> is a string comprising up to 24 ASCII printable characters, and it must be enclosed in quotes.

Setting the Z Coordinate

This command specifies the Z coordinate of an environmental sensor.

```
config:#  externalsensor <n> zlabel "<coordinate>"
```

Variables:

- <n> is the ID number of the environmental sensor that you want to configure. The ID number is available in the PX3 web interface or using the command "show externalsensors <n>" in the CLI. It is an integer between 1 and 32.
- Depending on the Z coordinate format you set, there are two types of values for the <coordinate> variable:

Type	Description
Free form	<coordinate> is a string comprising up to 24 ASCII printable characters, and it must be enclosed in quotes.
Rack units	<coordinate> is an integer number in rack units.

Note: To specify the Z coordinate using the rack units, see **Setting the Z Coordinate Format for Environmental Sensors** (on page 410).

Changing the Sensor Description

This command provides a description for a specific environmental sensor.

```
config:#  externalsensor <n> description "<description>"
```

Variables:

- <n> is the ID number of the environmental sensor that you want to configure. The ID number is available in the PX3 web interface or using the command "show externalsensors <n>" in the CLI. It is an integer between 1 and 32.
- <description> is a string comprising up to 64 ASCII printable characters, and it must be enclosed in quotes.

Using Default Thresholds

This command determines whether default thresholds, including the deassertion hysteresis and assertion timeout, are applied to a specific environmental sensor.

```
config:# externalsensor <n> useDefaultThresholds <option>
```

Variables:

- <n> is the ID number of the environmental sensor that you want to configure. The ID number is available in the PX3 web interface or using the command "show externalsensors <n>" in the CLI. It is an integer between 1 and 32.
- <option> is one of the options: *true* or *false*.

Option	Description
true	Default thresholds are selected as the threshold option for the specified sensor.
false	Sensor-specific thresholds are selected as the threshold option for the specified sensor.

Setting the Alarmed to Normal Delay for DX-PIR

This command determines the value of the Alarmed to Normal Delay setting for a DX-PIR presence detector.

```
config:# externalsensor <n> alarmedToNormalDelay <time>
```

Variables:

- <n> is the ID number of the environmental sensor that you want to configure. The ID number is available in the PX3 web interface or using the command "show externalsensors <n>" in the CLI. It is an integer between 1 and 32.
- <time> is an integer number in seconds, ranging between 0 and 300.

Examples

This section illustrates several environmental sensor configuration examples.

Example 1 - Environmental Sensor Naming

The following command assigns the name "Cabinet humidity" to the environmental sensor with the ID number 4.

```
config:# externalsensor 4 name "Cabinet humidity"
```

Example 2 - Sensor Threshold Selection

The following command sets the environmental sensor #1 to use the default thresholds, including the deassertion hysteresis and assertion timeout, as its threshold settings.

```
config:# externalsensor 1 useDefaultThresholds true
```

Configuring Environmental Sensors' Default Thresholds

You can set the default values of upper and lower thresholds, deassertion hysteresis and assertion timeout on a sensor type basis, including temperature, humidity, air pressure and air flow sensors. The default thresholds automatically apply to all environmental sensors that are newly detected or added.

A default threshold configuration command begins with *defaultThresholds*.

You can configure various default threshold settings for the same sensor type at a time by combining multiple commands. See **Multi-Command Syntax** (on page 520).

- ▶ **Set the Default Upper Critical Threshold for a specific sensor type:**

```
config:# defaultThresholds <sensor type> upperCritical <value>
```

- ▶ **Set the Default Upper Warning Threshold for a specific sensor type:**

```
config:# defaultThresholds <sensor type> upperWarning <value>
```

- ▶ **Set the Default Lower Critical Threshold for a specific sensor type:**

```
config:# defaultThresholds <sensor type> lowerCritical <value>
```

- ▶ **Set the Default Lower Warning Threshold for a specific sensor type:**

```
config:# defaultThresholds <sensor type> lowerWarning <value>
```

▶ **Set the Default Deassertion Hysteresis for a specific sensor type:**

```
config:# defaultThresholds <sensor type> hysteresis <hy_value>
```

▶ **Set the Default Assertion Timeout for a specific sensor type:**

```
config:# defaultThresholds <sensor type> assertionTimeout <as_value>
```

Variables:

- <sensor type> is one of the following numeric sensor types:

Sensor types	Description
absoluteHumidity	Absolute humidity sensors
relativeHumidity	Relative humidity sensors
temperature	Temperature sensors
airPressure	Air pressure sensors
airFlow	Air flow sensors
vibration	Vibration sensors

- <value> is the value for the specified threshold of the specified sensor type. Note that diverse sensor types use different measurement units.

Sensor types	Measurement units
absoluteHumidity	g/m ³ (that is, g/m ³)
relativeHumidity	%
temperature	Degrees Celsius (°C) or Fahrenheit (°F), depending on your measurement unit settings.
airPressure	Pascal (Pa) or psi, depending on your measurement unit settings.
airFlow	m/s

Sensor types	Measurement units
vibration	g

- <hy_value> is the deassertion hysteresis value applied to the specified sensor type.
- <as_value> is the assertion timeout value applied to the specified sensor type. It ranges from 0 to 100 (samples).

Example - Default Upper Thresholds for Temperature

It is assumed that your preferred measurement unit for temperature is set to degrees Celsius. Then the following command sets the default Upper Warning threshold to 20°C and Upper Critical threshold to 24°C for all temperature sensors.

```
config:# defaultThresholds temperature upperWarning 20
upperCritical 24
```

Sensor Threshold Configuration Commands

A sensor configuration command begins with *sensor*. You can use the commands to configure the threshold, hysteresis and assertion timeout values for any sensor associated with the following items:

- Outlets
- Inlets
- Inlet poles (for three-phase PDUs only)
- Overcurrent protectors
- Environmental sensors

It is permitted to assign a new value to the threshold at any time regardless of whether the threshold has been enabled.

Commands for Outlet Sensors

A sensor configuration command for outlets begins with *sensor outlet*. You can configure various outlet sensor threshold settings at a time by combining multiple commands. See **Multi-Command Syntax** (on page 520).

- ▶ **Set the Upper Critical threshold for an outlet sensor:**

```
config:# sensor outlet <n> <sensor type> upperCritical <option>
```

▶ **Set the Upper Warning threshold for an outlet sensor:**

```
config:# sensor outlet <n> <sensor type> upperWarning <option>
```

▶ **Set the Lower Critical threshold for an outlet sensor:**

```
config:# sensor outlet <n> <sensor type> lowerCritical <option>
```

▶ **Set the Lower Warning threshold for an outlet sensor:**

```
config:# sensor outlet <n> <sensor type> lowerWarning <option>
```

▶ **Set the deassertion hysteresis for an outlet sensor:**

```
config:# sensor outlet <n> <sensor type> hysteresis <hy_value>
```

▶ **Set the assertion timeout for an outlet sensor:**

```
config:# sensor outlet <n> <sensor type> assertionTimeout <as_value>
```

Variables:

- <n> is the number of the outlet that you want to configure.
- <sensor type> is one of the following sensor types:

Sensor type	Description
current	Current sensor
voltage	Voltage sensor
activePower	Active power sensor
apparentPower	Apparent power sensor
powerFactor	Power factor sensor
activeEnergy	Active energy sensor
lineFrequency	Line frequency sensor

Note: If the requested sensor type is not supported, the "Sensor is not available" message is displayed.

- <option> is one of the options: *enable*, *disable* or a numeric value.

Option	Description
enable	Enables the specified threshold for a specific outlet sensor.
disable	Disables the specified threshold for a specific outlet sensor.
A numeric value	Sets a value for the specified threshold of a specific outlet sensor and enables this threshold at the same time.

- <hy_value> is a numeric value that is assigned to the hysteresis for the specified outlet sensor. See *"To De-assert" and Deassertion Hysteresis* (on page 680).
- <as_value> is a number in samples that is assigned to the assertion timeout for the specified outlet sensor. See *"To Assert" and Assertion Timeout* (on page 678).

Commands for Inlet Sensors

A sensor configuration command for inlets begins with *sensor inlet*.

You can configure various inlet sensor threshold settings at a time by combining multiple commands. See *Multi-Command Syntax* (on page 520).

▶ **Set the Upper Critical threshold for an inlet sensor:**

```
config:# sensor inlet <n> <sensor type> upperCritical <option>
```

▶ **Set the Upper Warning threshold for an inlet sensor:**

```
config:# sensor inlet <n> <sensor type> upperWarning <option>
```

▶ **Set the Lower Critical threshold for an inlet sensor:**

```
config:# sensor inlet <n> <sensor type> lowerCritical <option>
```

▶ **Set the Lower Warning threshold for an inlet sensor:**

```
config:# sensor inlet <n> <sensor type> lowerWarning <option>
```

▶ **Set the deassertion hysteresis for an inlet sensor:**

```
config:# sensor inlet <n> <sensor type> hysteresis <hy_value>
```

▶ **Set the assertion timeout for an inlet sensor:**

```
config:# sensor inlet <n> <sensor type> assertionTimeout <as_value>
```

Variables:

- <n> is the number of the inlet that you want to configure. For a single-inlet PDU, <n> is always the number 1.
- <sensor type> is one of the following sensor types:

Sensor type	Description
current	Current sensor
peakCurrent	Peak current sensor
voltage	Voltage sensor
activePower	Active power sensor
apparentPower	Apparent power sensor
powerFactor	Power factor sensor
activeEnergy	Active energy sensor
unbalancedCurrent	Unbalanced load sensor
lineFrequency	Line frequency sensor
residualCurrent	Residual current sensor
phaseAngle	Inlet phase angle sensor

Note: If the requested sensor type is not supported, the "Sensor is not available" message is displayed.

- <option> is one of the options: *enable*, *disable* or a numeric value.

Option	Description
enable	Enables the specified threshold for a specific inlet sensor.

Option	Description
disable	Disables the specified threshold for a specific inlet sensor.
A numeric value	Sets a value for the specified threshold of a specific inlet sensor and enables this threshold at the same time.

- <hy_value> is a numeric value that is assigned to the hysteresis for the specified inlet sensor. See ***"To De-assert" and Deassertion Hysteresis*** (on page 680).
- <as_value> is a numeric value that is assigned to the assertion timeout for the specified inlet sensor. See ***"To Assert" and Assertion Timeout*** (on page 678).

Commands for Inlet Pole Sensors

A sensor configuration command for inlet poles begins with *sensor inletpole*. This type of command is available on a three-phase PDU only.

You can configure various inlet pole sensor threshold settings at a time by combining multiple commands. See ***Multi-Command Syntax*** (on page 520).

▶ Set the Upper Critical Threshold for an Inlet Pole:

```
config:# sensor inletpole <n> <p> <sensor type> upperCritical <option>
```

▶ Set the Upper Warning Threshold for an Inlet Pole:

```
config:# sensor inletpole <n> <p> <sensor type> upperWarning <option>
```

▶ Set the Lower Critical Threshold for an Inlet Pole:

```
config:# sensor inletpole <n> <p> <sensor type> lowerCritical <option>
```

▶ Set the Lower Warning Threshold for an Inlet Pole:

```
config:# sensor inletpole <n> <p> <sensor type> lowerWarning <option>
```

▶ Set the Inlet Pole's Deassertion Hysteresis:

```
config:# sensor inletpole <n> <p> <sensor type> hysteresis <hy_value>
```

▶ Set the Inlet Pole's Assertion Timeout:

```
config:# sensor inletpole <n> <p> <sensor type> assertionTimeout <as_value>
```

Variables:

- <n> is the number of the inlet whose pole sensors you want to configure.
- <p> is the label of the inlet pole that you want to configure.

Pole	Label <p>	Current sensor	Voltage sensor
1	L1	L1	L1 - L2
2	L2	L2	L2 - L3
3	L3	L3	L3 - L1

- <sensor type> is one of the following sensor types:

Sensor type	Description
current	Current sensor
voltage	Voltage sensor
activePower	Active power sensor
apparentPower	Apparent power sensor
powerFactor	Power factor sensor
activeEnergy	Active energy sensor
unbalancedCurrent	Unbalanced load sensor

Note: If the requested sensor type is not supported, the "Sensor is not available" message is displayed.

- <option> is one of the options: *enable*, *disable* or a numeric value.

Option	Description
enable	Enables the specified threshold for the specified inlet pole sensor.
disable	Disables the specified threshold for the specified inlet pole sensor.
A numeric value	Sets a value for the specified threshold of the specified inlet pole sensor and enables this threshold at the same time.

- <hy_value> is a numeric value that is assigned to the hysteresis for the specified inlet pole sensor. See ***"To De-assert" and Deassertion Hysteresis*** (on page 680).
- <as_value> is a number in samples that is assigned to the assertion timeout for the specified inlet pole sensor. See ***"To Assert" and Assertion Timeout*** (on page 678).

Commands for Overcurrent Protector Sensors

A sensor configuration command for overcurrent protectors begins with *sensor ocp*.

You can configure various overcurrent protector threshold settings at a time by combining multiple commands. See ***Multi-Command Syntax*** (on page 520).

▶ **Set the Upper Critical threshold for an overcurrent protector:**

```
config:# sensor ocp <n> <sensor type> upperCritical <option>
```

▶ **Set the Upper Warning threshold for an overcurrent protector:**

```
config:# sensor ocp <n> <sensor type> upperWarning <option>
```

▶ **Set the Lower Critical threshold for an overcurrent protector:**

```
config:# sensor ocp <n> <sensor type> lowerCritical <option>
```

▶ **Set the Lower Warning threshold for an overcurrent protector:**

```
config:# sensor ocp <n> <sensor type> lowerWarning <option>
```

▶ **Set the deassertion hysteresis for an overcurrent protector:**

```
config:# sensor ocp <n> <sensor type> hysteresis <hy_value>
```

▶ **Set the assertion timeout for an overcurrent protector:**

```
config:# sensor ocp <n> <sensor type> assertionTimeout <as_value>
```

Variables:

- <n> is the number of the overcurrent protector that you want to configure.
- <sensor type> is one of the following sensor types:

Sensor type	Description
current	Current sensor

Note: If the requested sensor type is not supported, the "Sensor is not available" message is displayed.

- <option> is one of the options: *enable*, *disable* or a numeric value.

Option	Description
enable	Enables the specified threshold for the overcurrent protector sensor.
disable	Disables the specified threshold for the overcurrent protector sensor.
A numeric value	Sets a value for the specified threshold of the overcurrent protector sensor and enables this threshold at the same time.

- <hy_value> is a numeric value that is assigned to the hysteresis for the specified overcurrent protector sensor. See *"To De-assert" and Deassertion Hysteresis* (on page 680).
- <as_value> is a number in samples that is assigned to the assertion timeout for the specified overcurrent protector sensor. See *"To Assert" and Assertion Timeout* (on page 678).

Commands for Environmental Sensors

A sensor threshold configuration command for environmental sensors begins with *sensor externalsensor*.

You can configure various environmental sensor threshold settings at a time by combining multiple commands. See *Multi-Command Syntax* (on page 520).

- ▶ **Set the Upper Critical threshold for an environmental sensor:**

```
config:# sensor externalsensor <n> <sensor type> upperCritical <option>
```

▶ **Set the Upper Warning threshold for an environmental sensor:**

```
config:# sensor externalsensor <n> <sensor type> upperWarning <option>
```

▶ **Set the Lower Critical threshold for an environmental sensor:**

```
config:# sensor externalsensor <n> <sensor type> lowerCritical <option>
```

▶ **Set the Lower Warning threshold for an environmental sensor:**

```
config:# sensor externalsensor <n> <sensor type> lowerWarning <option>
```

▶ **Set the deassertion hysteresis for an environmental sensor:**

```
config:# sensor externalsensor <n> <sensor type> hysteresis <hy_value>
```

▶ **Set the assertion timeout for an environmental sensor:**

```
config:# sensor externalsensor <n> <sensor type> assertionTimeout <as_value>
```

Variables:

- <n> is the ID number of the environmental sensor that you want to configure. The ID number is available in the PX3 web interface or using the command "show externalsensors <n>" in the CLI. It is an integer between 1 and 32.
- <sensor type> is one of these sensor types: *temperature*, *absoluteHumidity*, *relativeHumidity*, *airPressure*, *airFlow* or *vibration*.

Note: If the specified sensor type does not match the type of the specified environmental sensor, this error message appears: "Specified sensor type 'XXX' does not match the sensor's type (<sensortype>)," where XXX is the specified sensor type, and <sensortype> is the correct sensor type.

- <option> is one of the options: *enable*, *disable* or a numeric value.

Option	Description
enable	Enables the specified threshold for a specific environmental sensor.
disable	Disables the specified threshold for a specific environmental sensor.
A numeric value	Sets a value for the specified threshold of a specific environmental sensor and enables this threshold at the same time.

- <hy_value> is a numeric value that is assigned to the hysteresis for the specified environmental sensor. See *"To De-assert" and Deassertion Hysteresis* (on page 680).
- <as_value> is a number in samples that is assigned to the assertion timeout for the specified environmental sensor. It ranges between 1 and 100. See *"To Assert" and Assertion Timeout* (on page 678).

Examples

This section illustrates several environmental sensor threshold configuration examples.

Example 1 - Upper Critical Threshold for a Temperature Sensor

The following command sets the Upper Critical threshold of the environmental "temperature" sensor with the ID number 2 to 40 degrees Celsius. It also enables the upper critical threshold if this threshold has not been enabled yet.

```
config:# sensor externalsensor 2 temperature upperCritical 40
```

Example 2 - Warning Thresholds for Inlet Sensors

The following command sets both the Upper Warning and Lower Warning thresholds for the inlet 1 RMS current.

```
config:# sensor inlet 1 current upperWarning 20 lowerWarning 12
```

Results:

- The Upper Warning threshold for the inlet 1 RMS current is set to 20A. It also enables the upper warning threshold if this threshold has not been enabled yet.
- The Lower Warning threshold for the inlet 1 RMS current is set to 12A. It also enables the lower warning threshold if this threshold has not been enabled yet.

Example 3 - Upper Thresholds for Overcurrent Protector Sensors

The following command sets both the Upper Critical and Upper Warning thresholds for the 2nd overcurrent protector.

```
config:# sensor ocp 2 current upperWarning enable upperCritical 16
```

Results:

- The Upper Critical threshold for the 2nd overcurrent protector's RMS current is set to 16A. It also enables the upper critical threshold if this threshold has not been enabled yet.
- The Upper Warning threshold for the 2nd overcurrent protector's RMS current is enabled.

Actuator Configuration Commands

An actuator configuration command begins with *actuator*. You can configure the name and location parameters of an individual actuator. You can configure various parameters for one actuator at a time. See *Multi-Command Syntax* (on page 520).

▶ **Change the name:**

```
config:# actuator <n> name "<name>"
```

▶ **Set the X coordinate:**

```
config:# actuator <n> xlabel "<coordinate>"
```

▶ **Set the Y coordinate:**

```
config:# actuator <n> ylabel "<coordinate>"
```

▶ **Set the Z coordinate:**

```
config:# actuator <n> zlabel "<z_label>"
```

▶ **Modify the actuator's description:**

```
config:# actuator <n> description "<description>"
```

Variables:

- <n> is the ID number assigned to the actuator. The ID number can be found using the PX3 web interface or CLI. It is an integer starting at 1.
- <name> is a string comprising up to 32 ASCII printable characters. The <name> variable must be enclosed in quotes when it contains spaces.
- <coordinate> is a string comprising up to 24 ASCII printable characters, and it must be enclosed in quotes.
- There are two types of values for the <z_label> variable, depending on the Z coordinate format you set:

Type	Description
Free form	<coordinate> is a string comprising up to 24 ASCII printable characters, and it must be enclosed in quotes.
Rack units	<coordinate> is an integer number in rack units.

*Note: To specify the Z coordinate using the rack units, see **Setting the Z Coordinate Format for Environmental Sensors** (on page 410).*

- <description> is a sentence or paragraph comprising up to 64 ASCII printable characters, and it must be enclosed in quotes.

Example - Actuator Naming

The following command assigns the name "Door lock" to the actuator whose ID number is 9.

```
config:# actuator 9 name "Door lock"
```

Server Reachability Configuration Commands

You can use the CLI to add or delete an IT device, such as a server, from the server reachability list, or modify the settings for a monitored IT device. A server reachability configuration command begins with *serverReachability*.

Adding a Monitored Device

This command adds a new IT device to the server reachability list.

```
config:# serverReachability add <IP_host> <enable> <succ_ping>
<fail_ping> <succ_wait> <fail_wait> <resume> <disable_count>
```

Variables:

- <IP_host> is the IP address or host name of the IT device that you want to add.
- <enable> is one of the options: *true* or *false*.

Option	Description
true	Enables the ping monitoring feature for the newly added device.
false	Disables the ping monitoring feature for the newly added device.

- <succ_ping> is the number of successful pings for declaring the monitored device "Reachable." Valid range is 0 to 200.
- <fail_ping> is the number of consecutive unsuccessful pings for declaring the monitored device "Unreachable." Valid range is 1 to 100.
- <succ_wait> is the wait time to send the next ping after a successful ping. Valid range is 5 to 600 (seconds).
- <fail_wait> is the wait time to send the next ping after a unsuccessful ping. Valid range is 3 to 600 (seconds).
- <resume> is the wait time before the PX3 resumes pinging after declaring the monitored device "Unreachable." Valid range is 5 to 120 (seconds).
- <disable_count> is the number of consecutive "Unreachable" declarations before the PX3 disables the ping monitoring feature for the monitored device and returns to the "Waiting for reliable connection" state. Valid range is 1 to 100 or *unlimited*.

Deleting a Monitored Device

This command removes a monitored IT device from the server reachability list.

```
config:# serverReachability delete <n>
```

Variables:

- <n> is a number representing the sequence of the IT device in the monitored server list.
You can find each IT device's sequence number using the CLI command of `show serverReachability` as illustrated below.

#	IP address	Enabled	Status
1	192.168.84.126	Yes	Waiting for reliable connection
2	www.raritan.com	Yes	Waiting for reliable connection

Modifying a Monitored Device's Settings

The command to modify a monitored IT device's settings begins with `serverReachability modify`.

You can modify various settings for a monitored device at a time. See *Multi-Command Syntax* (on page 520).

- ▶ **Modify a device's IP address or host name:**

```
config:# serverReachability modify <n> ipAddress <IP_host>
```

- ▶ Enable or disable the ping monitoring feature for the device:

```
config:# serverReachability modify <n> pingMonitoringEnabled <option>
```

- ▶ Modify the number of successful pings for declaring "Reachable":

```
config:# serverReachability modify <n> numberOfSuccessfulPingsToEnable  
<succ_number>
```

- ▶ Modify the number of unsuccessful pings for declaring "Unreachable":

```
config:# serverReachability modify <n> numberOfUnsuccessfulPingsForFailure  
<fail_number>
```

- ▶ Modify the wait time after a successful ping:

```
config:# serverReachability modify <n> waitTimeAfterSuccessfulPing  
<succ_wait>
```

- ▶ Modify the wait time after a unsuccessful ping:

```
config:# serverReachability modify <n> waitTimeAfterUnsuccessfulPing  
<fail_wait>
```

- ▶ Modify the wait time before resuming pinging after declaring "Unreachable":

```
config:# serverReachability modify <n> waitTimeBeforeResumingPinging  
<resume>
```

- ▶ Modify the number of consecutive "Unreachable" declarations before disabling the ping monitoring feature:

```
config:# serverReachability modify <n> numberOfFailuresToDisable
<disable_count>
```

Variables:

- <n> is a number representing the sequence of the IT device in the server monitoring list.
- <IP_host> is the IP address or host name of the IT device whose settings you want to modify.
- <option> is one of the options: *true* or *false*.

Option	Description
true	Enables the ping monitoring feature for the monitored device.
false	Disables the ping monitoring feature for the monitored device.

- <succ_number> is the number of successful pings for declaring the monitored device "Reachable." Valid range is 0 to 200.
- <fail_number> is the number of consecutive unsuccessful pings for declaring the monitored device "Unreachable." Valid range is 1 to 100.
- <succ_wait> is the wait time to send the next ping after a successful ping. Valid range is 5 to 600 (seconds).
- <fail_wait> is the wait time to send the next ping after a unsuccessful ping. Valid range is 3 to 600 (seconds).
- <resume> is the wait time before the PX3 resumes pinging after declaring the monitored device "Unreachable." Valid range is 5 to 120 (seconds).
- <disable_count> is the number of consecutive "Unreachable" declarations before the PX3 disables the ping monitoring feature for the monitored device and returns to the "Waiting for reliable connection" state. Valid range is 1 to 100 or *unlimited*.

Example - Server Settings Changed

The following command modifies several ping monitoring settings for the second server in the server reachability list.

```
config:# serverReachability modify 2 numberOfSuccessfulPingsToEnable 10
numberOfUnsuccessfulPingsForFailure 8
waitTimeAfterSuccessfulPing 30
```

EnergyWise Configuration Commands

An EnergyWise configuration command begins with *energywise*.

Enabling or Disabling EnergyWise

This command syntax determines whether the Cisco® EnergyWise endpoint implemented on the PX3 device is enabled.

```
config:# energywise enabled <option>
```

Variables:

- <option> is one of the options: *true* or *false*.

Option	Description
true	The Cisco EnergyWise feature is enabled.
false	The Cisco EnergyWise feature is disabled.

Specifying the EnergyWise Domain

This command syntax specifies to which Cisco® EnergyWise domain the PX3 device belongs.

```
config:# energywise domain <name>
```

Variables:

- <name> is a string comprising up to 127 ASCII printable characters. Spaces and asterisks are NOT acceptable.

Specifying the EnergyWise Secret

This command syntax specifies the password (secret) to enter the Cisco® EnergyWise domain.

```
config:# energywise secret <password>
```

Variables:

- <password> is a string comprising up to 127 ASCII printable characters. Spaces and asterisks are NOT acceptable.

Changing the UDP Port

This command syntax specifies the UDP port for communications in the Cisco® EnergyWise domain.

```
config:# energywise port <port>
```

Variables:

- <port> is the UDP port number ranging between 1 and 65535.

Setting the Polling Interval

This command syntax determines the polling interval at which the Cisco® EnergyWise domain queries the PX3 device.

```
config:# energywise polling <timing>
```

Variables:

- <timing> is an integer number in seconds. It ranges between 30 and 600 seconds.

Example - Setting Up EnergyWise

The following command sets up two Cisco® EnergyWise-related features.

```
config:# energywise enabled true port 10288
```

Results:

- The EnergyWise feature implemented on the PX3 is enabled.
- The UDP port is set to 10288.

Asset Management Commands

You can use the CLI commands to change the settings of the connected asset strip (if any) or the settings of LEDs on the asset strip.

Asset Strip Management

An asset strip management configuration command begins with `assetStrip`.

Naming an Asset Strip

This command syntax names or changes the name of an asset strip connected to the PX3 device.

```
config:# assetStrip <n> name "<name>"
```

Variables:

- `<n>` is the number of the FEATURE port where the selected asset strip is physically connected. For the PX3 device with only one FEATURE port, the number is always 1.
- `<name>` is a string comprising up to 32 ASCII printable characters. The `<name>` variable must be enclosed in quotes when it contains spaces.

Specifying the Number of Rack Units

This command syntax specifies the total number of rack units on an asset strip connected to the PX3 device.

```
config:#  assetStrip <n> numberOfRackUnits <number>
```

Note: A rack unit refers to a tag port on the asset strips.

Variables:

- <n> is the number of the FEATURE port where the selected asset strip is physically connected. For the PX3 device with only one FEATURE port, the number is always 1.
- <number> is the total number of rack units available on the connected asset strip. This value ranges from 8 to 64.

Specifying the Rack Unit Numbering Mode

This command syntax specifies the numbering mode of rack units on the asset strips connected to the PX3 device. The numbering mode changes the rack unit numbers.

```
config:#  assetStrip <n> rackUnitNumberingMode <mode>
```

Variables:

- <n> is the number of the FEATURE port where the selected asset strip is physically connected. For the PX3 device with only one FEATURE port, the number is always 1.
- <mode> is one of the numbering modes: *topDown* or *bottomUp*.

Mode	Description
topDown	The rack units are numbered in the ascending order from the highest to the lowest rack unit.
bottomUp	The rack units are numbered in the descending order from the highest to the lowest rack unit.

Specifying the Rack Unit Numbering Offset

This command syntax specifies the starting number of rack units on the asset strips connected to the PX3 device.

```
config:#  assetStrip <n> rackUnitNumberingOffset <number>
```

Variables:

- <n> is the number of the FEATURE port where the selected asset strip is physically connected. For the PX3 device with only one FEATURE port, the number is always 1.
- <number> is a starting number for numbering rack units on the connected asset strip. This value is an integer number.

Specifying the Asset Strip Orientation

This command syntax specifies the orientation of the asset strips connected to the PX3 device. Usually you do not need to perform this command unless your asset strips do NOT come with the tilt sensor, causing the PX3 unable to detect the asset strips' orientation.

```
config:#  assetStrip <n> assetStripOrientation <orientation>
```

Variables:

- <n> is the number of the FEATURE port where the selected asset strip is physically connected. For the PX3 device with only one FEATURE port, the number is always 1.
- <orientation> is one of the options: *topConnector* or *bottomConnector*.

Orientation	Description
topConnector	This option indicates that the asset sensor is mounted with the RJ-45 connector located on the top.
bottomConnector	This option indicates that the asset sensor is mounted with the RJ-45 connector located at the bottom.

Setting LED Colors for Connected Tags

This command syntax sets the LED color for all rack units on the asset strip #1 to indicate the presence of a connected asset tag.

```
config:#    assetStrip <n> LEDColorForConnectedTags <color>
```

Variables:

- <color> is the hexadecimal RGB value of a color in HTML format. The <color> variable ranges from #000000 to #FFFFFF.

Setting LED Colors for Disconnected Tags

This command syntax sets the LED color for all rack units on the connected asset strip(s) to indicate the absence of a connected asset tag.

```
config:#    assetStrip <n> LEDColorForDisconnectedTags <color>
```

Variables:

- <color> is the hexadecimal RGB value of a color in HTML format. The <color> variable ranges from #000000 to #FFFFFF.

Rack Unit Configuration

A rack unit refers to a tag port on the asset strips. A rack unit configuration command begins with `rackUnit`.

Naming a Rack Unit

This command syntax assigns or changes the name of the specified rack unit on the specified asset strip.

```
config:# rackUnit <n> <rack_unit> name "<name>"
```

Variables:

- <n> is the number of the FEATURE port where the selected asset strip is physically connected. For the PX3 device with only one FEATURE port, the number is always 1.
- <rack_unit> is the index number of the desired rack unit. The index number is available on the asset strip or the Asset Strip page of the web interface.
- <name> is a string comprising up to 32 ASCII printable characters. The <name> variable must be enclosed in quotes when it contains spaces.

Setting the LED Operation Mode

This command syntax determines whether a specific rack unit on the specified asset strip follows the global LED color settings.

```
config:# rackUnit <n> <rack_unit> LEDOperationMode <mode>
```

Variables:

- <n> is the number of the FEATURE port where the selected asset strip is physically connected. For the PX3 device with only one FEATURE port, the number is always 1.
- <rack_unit> is the index number of the desired rack unit. The index number is available on the asset strip or the Asset Strip page of the web interface.
- <mode> is one of the LED modes: *automatic* or *manual*.

Mode	Description
automatic	This option makes the LED of the specified rack unit follow the global LED color settings. See <i>Setting LED Colors for Connected Tags</i> (on page 514) and <i>Setting LED Colors for Disconnected Tags</i> (on page 514). This is the default.

Mode	Description
manual	This option enables selection of a different LED color and LED mode for the specified rack unit. When this option is selected, see <i>Setting an LED Color for a Rack Unit</i> (on page 516) and <i>Setting an LED Mode for a Rack Unit</i> (on page 517) to set different LED settings.

Setting an LED Color for a Rack Unit

This command syntax sets the LED color for a specific rack unit on the specified asset strip. You need to set a rack unit's LED color only when the LED operation mode of this rack unit has been set to "manual."

```
config:#   rackUnit <n> <rack_unit> LEDColor <color>
```

Variables:

- <n> is the number of the FEATURE port where the selected asset strip is physically connected. For the PX3 device with only one FEATURE port, the number is always 1.
- <rack_unit> is the index number of the desired rack unit. The index number is available on the asset strip or the Asset Strip page of the web interface.
- <color> is the hexadecimal RGB value of a color in HTML format. The <color> variable ranges from #000000 to #FFFFFF.

*Note: A rack unit's LED color setting overrides the global LED color setting on it. See **Setting LED Colors for Connected Tags** (on page 514) and **Setting LED Colors for Disconnected Tags** (on page 514).*

Setting an LED Mode for a Rack Unit

This command syntax sets the LED mode for a specific rack unit on the specified asset strip. You need to set a rack unit's LED mode only when the LED operation mode of this rack unit has been set to "manual."

```
config:#   rackUnit <n> <rack_unit> LEDMode <mode>
```

Variables:

- <n> is the number of the FEATURE port where the selected asset strip is physically connected. For the PX3 device with only one FEATURE port, the number is always 1.
- <rack_unit> is the index number of the desired rack unit. The index number is available on the asset strip or the Asset Strip page of the web interface.
- <mode> is one of the LED modes: *on*, *off*, *blinkSlow* or *blinkFast*.

Mode	Description
on	This mode has the LED stay lit permanently.
off	This mode has the LED stay off permanently.
blinkSlow	This mode has the LED blink slowly.
blinkFast	This mode has the LED blink quickly.

Examples

This section illustrates several asset management examples.

Example 1 - Asset Strip LED Colors for Disconnected Tags

This command syntax sets the LED color for all rack units on the asset sensor #1 to BLACK (that is, 000000) to indicate the absence of a connected asset tag.

```
config:#   assetStrip 1 LEDColorForDisconnectedTags #000000
```

Note: Black color causes the LEDs to stay off.

Example 2 - Rack Unit Naming

The following command assigns the name "Linux server" to the rack unit whose index number is 25 on the asset sensor#1.

```
config:# rackUnit 1 25 name "Linux server"
```

Serial Port Configuration Commands

A serial port configuration command begins with *serial*.

Setting the Baud Rates

The following commands set the baud rate (bps) of the serial port labeled CONSOLE / MODEM on the PX3 device. Change the baud rate before connecting it to the desired device, such as a computer, a Raritan's P2CIM-SER, or a modem, through the serial port, or there are communications errors. If you change the baud rate dynamically after the connection has been made, you must reset the PX3 or power cycle the connected device for proper communications.

► Determine the CONSOLE baud rate:

```
config:# serial consoleBaudRate <baud_rate>
```

Note: The serial port bit-rate change is required when the PX3 works in conjunction with Raritan's Dominion LX KVM switch. Dominion LX only supports 19200 bps for communications over the serial interface.

► Determine the MODEM baud rate:

```
config:# serial modemBaudRate <baud_rate>
```

Variables:

- <baud_rate> is one of the baud rate options: 1200, 2400, 4800, 9600, 19200, 38400, 57600, 115200.

Forcing the Device Detection Mode

This command forces the serial port on the PX3 to enter a specific device detection mode.

```
config:# serial deviceDetectionType <mode>
```

Variables:

- <mode> is one of the detection modes: *automatic*, *forceConsole*, *forceAnalogModem*, or *forceGsmModem*.

Option	Description
automatic	The PX3 automatically detects the type of the device connected to the serial port. Select this option unless your PX3 cannot correctly detect the device type.
forceConsole	The PX3 attempts to recognize that the connected device is set for the console mode.
forceAnalogModem	The PX3 attempts to recognize that the connected device is an analog modem.
forceGsmModem	The PX3 attempts to recognize that the connected device is a GSM modem.

Example

The following command sets the CONSOLE baud rate of the PX3 device's serial port to 9600 bps.

```
config:# serial consoleBaudRate 9600
```

Setting the History Buffer Length

This command syntax sets the history buffer length, which determines the amount of history commands that can be retained in the buffer. The default length is 25.

```
config:# history length <n>
```

Variables:

- <n> is an integer number between 1 and 250.

Multi-Command Syntax

To shorten the configuration time, you can combine various configuration commands in one command to perform all of them at a time. All combined commands must belong to the same configuration type, such as commands prefixed with *network*, *user modify*, *sensor externalsensor* and so on.

A multi-command syntax looks like this:

```
<configuration type> <setting 1> <value 1> <setting 2>
<value 2> <setting 3> <value 3> ...
```

Example 1 - Combination of IP, Subnet Mask and Gateway Parameters

The following multi-command syntax configures IPv4 address, subnet mask and gateway for the network connectivity simultaneously.

```
config:# network ipv4 ipAddress 192.168.84.225 subnetMask 255.255.255.0
gateway 192.168.84.0
```

Results:

- The IP address is set to 192.168.84.225.
- The subnet mask is set to 255.255.255.0.
- The gateway is set to 192.168.84.0.

Example 2 - Combination of Upper Critical and Upper Warning Settings

The following multi-command syntax simultaneously configures Upper Critical and Upper Warning thresholds for the RMS current of the 2nd overcurrent protector.

```
config:# sensor ocp 2 current upperCritical disable upperWarning 15
```

Results:

- The Upper Critical threshold of the 2nd overcurrent protector's RMS current is disabled.
- The Upper Warning threshold of the 2nd overcurrent protector's RMS current is set to 15A and enabled at the same time.

Example 3 - Combination of SSID and PSK Parameters

This multi-command syntax configures both SSID and PSK parameters simultaneously for the wireless feature.

```
config:# network wireless SSID myssid PSK encryp_key
```

Results:

- The SSID value is set to myssid.
- The PSK value is set to encryp_key.

Example 4 - Combination of Upper Critical, Upper Warning and Lower Warning Settings

The following multi-command syntax configures Upper Critical, Upper Warning and Lower Warning thresholds for the outlet 5 RMS current simultaneously.

```
config:# sensor outlet 5 current upperCritical disable upperWarning enable  
lowerWarning 1.0
```

Results:

- The Upper Critical threshold of outlet 5 RMS current is disabled.
- The Upper Warning threshold of outlet 5 RMS current is enabled.
- The Lower Warning threshold of outlet 5 RMS current is set to 1.0A and enabled at the same time.

Load Shedding Configuration Commands

This section applies to outlet-switching capable models only.

A load shedding configuration command begins with *loadshedding*.

Unlike other CLI configuration commands, the load shedding configuration command is performed in the *administrator mode* rather than the configuration mode. See *Different CLI Modes and Prompts* (on page 368).

Enabling or Disabling Load Shedding

This section applies to outlet-switching capable models only.

This command determines whether to enter or exit from the load shedding mode.

```
#          loadshedding <option>
```

After performing the above command, PX3 prompts you to confirm the operation. Press *y* to confirm or *n* to abort the operation.

To skip the confirmation step, you can add the */y* parameter to the end of the command so that the operation is executed immediately.

```
#          loadshedding <option> /y
```

Variables:

- *<option>* is one of the options: *enable* or *disable*.

Option	Description
start	Enter the load shedding mode.
stop	Quit the load shedding mode.

Example

The following command has the PX3 enter the load shedding mode.

```
config:#  loadshedding start
```

Power Control Operations

This section applies to outlet-switching capable models only.

Outlets on the PX3 device can be turned on or off or power cycled through the CLI.

Besides, you can cancel the power-on process while the PX3 is powering on ALL outlets.

You must perform this operation in the *administrator mode*. See *Different CLI Modes and Prompts* (on page 368).

Turning On the Outlet(s)

This section applies to outlet-switching capable models only.

This command turns on one or multiple outlets.

```
#          power outlets <numbers> on
```

To quicken the operation, you can add the parameter `"/y"` to the end of the command, which confirms the operation.

```
#          power outlets <numbers> on /y
```

Variables:

- `<numbers>` is one of the options: *all*, an outlet number, a list or a range of outlets.

Option	Description
all	Switches ON all outlets.
A specific outlet number	Switches ON the specified outlet.
A comma-separated list of outlets	Switches ON multiple, inconsecutive or consecutive outlets. For example, to specify 7 outlets -- 2, 4, 9, 11, 12, 13 and 15, type <code>outlets 2,4,9,11-13,15</code> .
A range of outlets with an en dash in between	Switches ON multiple, consecutive outlets. For example, to specify 6 consecutive outlets -- 3, 4, 5, 6, 7, 8, type <code>outlets 3-8</code> .

If you entered the command without `/y`, a message appears, prompting you to confirm the operation. Then:

- Type `y` to confirm the operation, OR
- Type `n` to abort the operation

Turning Off the Outlet(s)

This section applies to outlet-switching capable models only.

This command turns off one or multiple outlets.

```
# power outlets <numbers> off
```

To quicken the operation, you can add the parameter `/y` to the end of the command, which confirms the operation.

```
# power outlets <numbers> off /y
```

Variables:

- `<numbers>` is one of the options: *all*, an outlet number, a list or a range of outlets.

Option	Description
all	Switches OFF all outlets.
A specific outlet number	Switches OFF the specified outlet.
A comma-separated list of outlets	Switches OFF multiple, inconsecutive or consecutive outlets. For example, to specify 7 outlets -- 2, 4, 9, 11, 12, 13 and 15, type <code>outlets 2,4,9,11-13,15</code> .
A range of outlets with an en dash in between	Switches OFF multiple, consecutive outlets. For example, to specify 6 consecutive outlets -- 3, 4, 5, 6, 7, 8, type <code>outlets 3-8</code> .

If you entered the command without `/y`, a message appears, prompting you to confirm the operation. Then:

- Type `y` to confirm the operation, OR
- Type `n` to abort the operation

Power Cycling the Outlet(s)

This section applies to outlet-switching capable models only.

This command power cycles one or multiple outlets.

```
# power outlets <numbers> cycle
```

To quicken the operation, you can add the parameter `/y` to the end of the command, which confirms the operation.

```
# power outlets <numbers> cycle /y
```

Variables:

- `<numbers>` is one of the options: *all*, an outlet number, a list or a range of outlets.

Option	Description
all	Power cycles all outlets.
A specific outlet number	Power cycles the specified outlet.
A comma-separated list of outlets	Power cycles multiple, inconsecutive or consecutive outlets. For example, to specify 7 outlets -- 2, 4, 9, 11, 12, 13 and 15, type <code>outlets 2,4,9,11-13,15</code> .
A range of outlets with an en dash in between	Power cycles multiple, consecutive outlets. For example, to specify 6 consecutive outlets -- 3, 4, 5, 6, 7, 8, type <code>outlets 3-8</code> .

If you entered the command without `/y`, a message appears, prompting you to confirm the operation. Then:

- Type `y` to confirm the operation, OR
- Type `n` to abort the operation

Canceling the Power-On Process

This section applies to outlet-switching capable models only.

After issuing the command to power on ALL outlets, you can use the following command to stop the power-on process.

```
# power cancelSequence
```

To quicken the operation, you can add the parameter `/y` to the end of the command, which confirms the operation.

```
# power cancelSequence /y
```

Example - Power Cycling Specific Outlets

The following command power cycles these outlets: 2, 6, 7, 8, 10, 13, 14, 15 and 16.

```
# power outlets 2,6-8,10,13-16 cycle
```

Actuator Control Operations

An actuator, which is connected to a dry contact signal channel of a DX sensor, can control a mechanism or system. You can switch on or off that mechanism or system through the actuator control command in the CLI.

Perform these commands in the administrator or user mode. See *Different CLI Modes and Prompts* (on page 368).

Switching On an Actuator

This command syntax turns on one actuator.

```
# control actuator <n> on
```

To quicken the operation, you can add the parameter `/y` to the end of the command, which confirms the operation.

```
# control actuator <n> on /y
```

Variables:

- `<n>` is an actuator's ID number.
The ID number is available in the PX3 web interface or using the `show` command in the CLI. It is an integer between 1 and 32.

If you entered the command without `/y`, a message appears, prompting you to confirm the operation. Then:

- Type `y` to confirm the operation, OR
- Type `n` to abort the operation

Switching Off an Actuator

This command syntax turns off one actuator.

```
# control actuator <n> off
```

To quicken the operation, you can add the parameter `/y` to the end of the command, which confirms the operation.

```
# control actuator <n> off /y
```

Variables:

- `<n>` is an actuator's ID number.
The ID number is available in the PX3 web interface or using the `show` command in the CLI. It is an integer between 1 and 32.

If you entered the command without `/y`, a message appears, prompting you to confirm the operation. Then:

- Type `y` to confirm the operation, OR
- Type `n` to abort the operation

Example - Turning On a Specific Actuator

The following command turns on the actuator whose ID number is 8.

```
# control actuator 8 on
```

Unlocking a User

If any user is blocked from accessing the PX3, you can unblock them at the local console.

► **To unblock a user:**

1. Log in to the CLI interface using any terminal program via a local connection. See *With HyperTerminal* (on page 366).
2. When the Username prompt appears, type `unlock` and press Enter.

Username: `unlock`

3. When the "Username to unlock" prompt appears, type the name of the blocked user and press Enter.

Username to unlock:

4. A message appears, indicating that the specified user was unblocked successfully.

Resetting the PX3

You can reset the PX3 device to factory defaults or simply restart it using the CLI commands.

Restarting the PDU

This command restarts the PX3 device. It is not a factory default reset.

► **To restart the PX3 device:**

1. Ensure you have entered administrator mode and the # prompt is displayed.
2. Type either of the following commands to restart the PX3 device.

```
#    reset unit
      -- OR --
#    reset unit /y
```
3. If you entered the command without "/y" in Step 2, a message appears prompting you to confirm the operation. Type y to confirm the reset.
4. Wait until the Username prompt appears, indicating the reset is complete.

Note: If you are performing this command over a USB connection, re-connect the USB cable after the reset is completed, or the CLI communications are lost.

Resetting Active Energy Readings

You can reset either one active energy sensor or all active energy sensors at a time to restart the energy accumulation process.

Only users with the "Admin" role assigned can reset active energy readings.

► **To reset all active energy readings of the PX3:**

```
#    reset activeEnergy pdu
      -- OR --
#    reset activeEnergy pdu /y
```

► **To reset one inlet's active energy readings:**

```
#    reset activeEnergy inlet <n>
      -- OR --
#    reset activeEnergy inlet <n> /y
```

► **To reset one outlet's active energy readings:**

```
#    reset activeEnergy outlet <outlet_n>
```



```
-- OR --
```

```
# reset activeEnergy outlet <outlet_n> /y
```

If you entered the command without `/y`, a message appears prompting you to confirm the operation. Type `y` to confirm the reset or `n` to abort it.

Variables:

- `<n>` is the inlet number.
- `<outlet_n>` is an outlet number.

Resetting to Factory Defaults

The following commands restore all settings of the PX3 device to factory defaults.

► **To reset PX3 settings after login, use either command:**

```
# reset factorydefaults
```

```
-- OR --
```

```
# reset factorydefaults /y
```

► **To reset PX3 settings before login:**

```
Username: factorydefaults
```

See *Using the CLI Command* (on page 586) for details.

Network Troubleshooting

The PX3 provides 4 diagnostic commands for troubleshooting network problems: *nslookup*, *netstat*, *ping*, and *traceroute*. The diagnostic commands function as corresponding Linux commands and can get corresponding Linux outputs.

Entering Diagnostic Mode

Diagnostic commands function in the diagnostic mode only.

► **To enter the diagnostic mode:**

1. Enter either of the following modes:
 - Administrator mode: The `#` prompt is displayed.
 - User mode: The `>` prompt is displayed.
2. Type `diag` and press Enter. The `diag#` or `diag>` prompt appears, indicating that you have entered the diagnostic mode.
3. Now you can type any diagnostic commands for troubleshooting.

Quitting Diagnostic Mode

- ▶ To quit the diagnostic mode, use this command:

```
diag>      exit
```

The # or > prompt appears after pressing Enter, indicating that you have entered the administrator or user mode. See *Different CLI Modes and Prompts* (on page 368).

Diagnostic Commands

The diagnostic command syntax varies from command to command.

Querying DNS Servers

This command syntax queries Internet domain name server (DNS) information of a network host.

```
diag>      nslookup <host>
```

Variables:

- <host> is the name or IP address of the host whose DNS information you want to query.

Showing Network Connections

This command syntax displays network connections and/or status of ports.

```
diag>      netstat <option>
```

Variables:

- <option> is one of the options: *ports* or *connections*.

Option	Description
ports	Shows TCP/UDP ports.
connections	Shows network connections.

Testing the Network Connectivity

This ping command sends the ICMP ECHO_REQUEST message to a network host for checking its network connectivity. If the output shows the host is responding properly, the network connectivity is good. If not, either the host is shut down or it is not being properly connected to the network.

```
diag> ping <host>
```

Variables:

- <host> is the host name or IP address whose networking connectivity you want to check.

Options:

- You can include any or all of additional options listed below in the ping command.

Options	Description
count <number1>	Determines the number of messages to be sent. <number1> is an integer number between 1 and 100.
size <number2>	Determines the packet size. <number2> is an integer number in bytes between 1 and 65468.
timeout <number3>	Determines the waiting period before timeout. <number3> is an integer number in seconds ranging from 1 to 600.

The command looks like the following when it includes all options:

```
diag> ping <host> count <number1> size <number2> timeout <number3>
```

Tracing the Route

This command syntax traces the network route between your PX3 device and a network host.

```
diag>          traceroute <host>
```

Variables:

- <host> is the name or IP address of the host you want to trace.

Example - Ping Command

The following command checks the network connectivity of the host 192.168.84.222 by sending the ICMP ECHO_REQUEST message to the host for 5 times.

```
diag>          ping 192.168.84.222 count 5
```

Retrieving Previous Commands

If you would like to retrieve any command that was previously typed in the same connection session, press the Up arrow (↑) on the keyboard until the desired command is displayed.

Automatically Completing a Command

A CLI command always consists of several words. You can easily enter a command by typing first word(s) or letter(s) and then pressing Tab or Ctrl+i instead of typing the whole command word by word.

► **To have a command completed automatically:**

1. Type initial letters or words of the desired command. Make sure the letters or words you typed are unique so that the CLI can identify the command you want.
2. Press Tab or Ctrl+i until the complete command appears.

Example 1:

Type the first word and the first letter of the second word of the "reset factorydefaults" command, that is, `reset f`. Then press Tab or Ctrl+i to complete the second word.

Example 2:

Type the first word and initial letters of the second word of the "security enforceHttpsForWebAccess" command, that is, `security enf`. Then press Tab or Ctrl+i to complete the second word.

Logging out of CLI

After completing your tasks using the CLI, always log out of the CLI to prevent others from accessing the CLI.

► **To log out of the CLI:**

1. Ensure you have entered administrator mode and the # prompt is displayed.
2. Type `exit` and press Enter.

Chapter 9 Using SCP Commands

You can perform a Secure Copy (SCP) command to update the PX3 firmware, do bulk configuration, or back up and restore the configuration.

In This Chapter

Firmware Update via SCP	535
Bulk Configuration via SCP	536
Backup and Restore via SCP	537
Downloading Diagnostic Data via SCP	538

Firmware Update via SCP

Same as any PX3 firmware update, all user management operations are suspended and all login attempts fail during the SCP firmware update. For details, see *Updating the PX3 Firmware* (on page 341).

Warning: Do NOT perform the firmware upgrade over a wireless network connection.

► To update the firmware via SCP:

1. Type the following SCP command and press Enter.

```
scp <firmware file> <user name>@<device ip>:/fwupdate
```

 - *<firmware file>* is the PX3 firmware's filename. If the firmware file is not in the current directory, you must include the path in the filename.
 - *<user name>* is the "admin" or any user profile with the Firmware Update permission.
 - *<device ip>* is the IP address of the PX3 that you want to update.
2. When the system prompts you to enter the password for the specified user profile, type it and press Enter.
3. The system transmits the specified firmware file to the PX3, and shows the transmission speed and percentage.
4. When the transmission is complete, it shows the following message, indicating that the PX3 starts to update its firmware now. Wait until the upgrade completes.

```
Starting firmware update. The connection will be closed now.
```

▶ **SCP example:**

```
scp pdu-px2-030000-41270.bin
admin@192.168.87.50:/fwupdate
```

▶ **Windows PSCP command:**

PSCP in Windows works in a similar way to the SCP.

- `pscp <firmware file> <user name>@<device ip>:/fwupdate`

Bulk Configuration via SCP

Like performing bulk configuration via the web interface, there are two steps with the bulk configuration using the SCP commands:

- a. Save a configuration from a source PX3.
- b. Copy the configuration file to one or multiple destination PX3.

For detailed information on the bulk configuration requirements, see ***Bulk Configuration*** (on page 344).

▶ **To save the configuration via SCP:**

1. Type the following SCP command and press Enter.

```
scp <user name>@<device ip>:/bulk_config.xml
```

- *<user name>* is the "admin" or any user profile with the administrator privileges.
- *<device ip>* is the IP address of the PX3 whose configuration you want to save.

2. Type the user password when prompted.
3. The system saves the configuration from the PX3 to a file named "bulk_config.xml."

▶ **To copy the configuration via SCP:**

1. Type the following SCP command and press Enter.

```
scp bulk_config.xml <user name>@<device ip>:/bulk_restore
```

- *<user name>* is the "admin" or any user profile with the administrator privileges.
- *<device ip>* is the IP address of the PX3 whose configuration you want to copy.

2. Type the user password when prompted.

3. The system copies the configuration included in the file "bulk_config.xml" to another PX3, and displays the following message.
Starting restore operation. The connection will be closed now.

▶ **SCP examples:**

- Save operation:

```
scp admin@192.168.87.50:/bulk_config.xml
```
- Copy operation:

```
scp bulk_config.xml  
admin@192.168.87.47:/bulk_restore
```

▶ **Windows PSCP commands:**

PSCP in Windows works in a similar way to the SCP.

- Save operation:

```
pscp <user name>@<device ip>:/bulk_config.xml
```
- Copy operation:

```
pscp bulk_config.xml <user name>@<device  
ip>:/bulk_restore
```

Backup and Restore via SCP

To back up ALL settings of a PX3, including device-specific settings, you should perform the backup operation instead of the bulk configuration. You can restore all settings to previous ones after a backup file is available.

▶ **To back up the settings via SCP:**

1. Type the following SCP command and press Enter.

```
scp <user name>@<device ip>:/backup_settings.xml
```

 - *<user name>* is the "admin" or any user profile with the administrator privileges.
 - *<device ip>* is the IP address of the PX3 whose settings you want to back up.
2. Type the user password when prompted.
3. The system saves the settings from the PX3 to a file named "backup_settings.xml."

▶ **To restore the settings via SCP:**

1. Type the following SCP command and press Enter.

```
scp backup_settings.xml <user name>@<device ip>:/settings_restore
```

- *<user name>* is the "admin" or any user profile with the administrator privileges.
 - *<device ip>* is the IP address of the PX3 whose settings you want to restore.
2. Type the user password when prompted.
 3. The system copies the configuration included in the file "backup_settings.xml" to the PX3, and displays the following message.
Starting restore operation. The connection will be closed now.

▶ **SCP examples:**

- Backup operation:
scp admin@192.168.87.50:/backup_settings.xml
- Restoration operation:
scp backup_settings.xml
admin@192.168.87.50:/settings_restore

▶ **Windows PSCP commands:**

PSCP in Windows works in a similar way to the SCP.

- Backup operation:
pscp <user name>@<device ip>:/backup_settings.xml
- Restoration operation:
pscp backup_settings.xml <user name>@<device ip>:/settings_restore

Downloading Diagnostic Data via SCP

You can download the diagnostic data via SCP.

▶ **To download the diagnostic data via SCP:**

1. Type the following SCP command and press Enter.
scp <user name>@<device ip>:/diag-data.tgz
 - *<user name>* is the "admin" or any user profile with the Administrator or "Unrestricted View Privileges" privileges.
 - *<device ip>* is the IP address of the PX3 whose diagnostic data you want to download.
2. Type the password when the system prompts you to type it.

3. The system saves the diagnostic data from the PX3 to a file named "diag-data.tgz."

▶ **SCP example:**

```
scp admin@192.168.87.50:/diag-data.tgz
```

▶ **Windows PSCP command:**

PSCP in Windows works in a similar way to the SCP.

- `pscp <user name>@<device ip>:/diag-data.tgz`

Appendix A Specifications

In This Chapter

Maximum Ambient Operating Temperature.....	540
Serial RS-232 "DB9" Port Pinouts	540
Serial RS-232 "RJ-45" Port Pinouts (for iX7™ Only).....	541
Sensor RJ-45 Port Pinouts.....	541
Feature RJ-45 Port Pinouts	542
Expansion RJ-45 Port Pinouts (for iX7™ Only)	542

Maximum Ambient Operating Temperature

The maximum ambient operating temperature (TMA) for PX3 varies from 50 to 60 degrees Celsius, depending on the model and certification standard (CE or UL). If necessary, contact Raritan Technical Support for this information for your model.

Specification	Measure
Max Ambient Temperature	50 to 60 degrees Celsius

Serial RS-232 "DB9" Port Pinouts

RS-232 Pin/signal definition			
Pin No.	Signal	Direction	Description
1	DCD	Input	Data
2	RxD	Input	Receive data (data in)
3	TxD	Output	Transmit data
4	DTR	Output	Data terminal ready
5	GND	—	Signal ground
6	DSR	Input	Data set ready
7	RTS	Output	Request to send
8	CTS	Input	Clear to send
9	RI	Input	Ring indicator

Serial RS-232 "RJ-45" Port Pinouts (for iX7™ Only)

RJ-45 Pin/signal definition			
Pin No.	Signal	Direction	Description
1	RTS	Output	Request to send
2	DTR	Output	Data terminal ready
3	TxD	Output	Transmit data
4	GND	—	Signal ground
5	DCD	Input	Data
6	RxD	Input	Receive data (data in)
7	DSR	Input	Data set ready
8	CTS	Input	Clear to send

Sensor RJ-45 Port Pinouts

RJ-45 Pin/signal definition			
Pin No.	Signal	Direction	Description
1	+12V	—	Power (fuse protected)
2	+12V	—	Power (fuse protected)
3	GND	—	Signal Ground
4	RS485_DP	bi-directional	Data Positive of the RS-485 bus
5	RS485_DN	bi-directional	Data Negative of the RS-485 bus
6	GND	—	Signal Ground
7	1-wire	—	Used for Feature Port
8	GND	—	Signal Ground

Note: A maximum of 500mA power is permitted for both pin 1 and pin 2 altogether.

Feature RJ-45 Port Pinouts

RJ-45 Pin/signal definition			
Pin No.	Signal	Direction	Description
1	DTR	Output	Reserved
2	GND	—	Signal Ground
3	+5V	—	Power for CIM (200mA, fuse protected) Warning: Pin 3 is only intended for use with Raritan devices.
4	TxD	Output	Transmit Data (Data out)
5	RxD	Input	Receive Data (Data in)
6	+12V	—	Warning: Pin 6 is only intended for use with Raritan devices. Do NOT connect.
7	GND	—	Signal Ground
8	DCD	Input	Reserved

Expansion RJ-45 Port Pinouts (for iX7™ Only)

RJ-45 Pin/signal definition			
Pin No.	Signal	Direction	Description
1	+12V	—	Power (fuse protected)
2	+12V	—	Power (fuse protected)
3	GND	—	Signal Ground

RJ-45 Pin/signal definition			
4	RS485_DP	bi-directional	Data Positive of the RS-485 bus
5	RS485_DN	bi-directional	Data Negative of the RS-485 bus
6	GND	—	Signal Ground
7	NC	—	No Connection
8	GND	—	Signal Ground

Appendix B Equipment Setup Worksheet

PX3 Series Model _____

PX3 Series Serial Number _____

OUTLET 1	OUTLET 2	OUTLET 3
MODEL	MODEL	MODEL
SERIAL NUMBER	SERIAL NUMBER	SERIAL NUMBER
USE	USE	USE
OUTLET 4	OUTLET 5	OUTLET 6
MODEL	MODEL	MODEL
SERIAL NUMBER	SERIAL NUMBER	SERIAL NUMBER
USE	USE	USE

Appendix B: Equipment Setup Worksheet

OUTLET 7	OUTLET 8	OUTLET 9
MODEL	MODEL	MODEL
SERIAL NUMBER	SERIAL NUMBER	SERIAL NUMBER
USE	USE	USE
OUTLET 10	OUTLET 11	OUTLET 12
MODEL	MODEL	MODEL
SERIAL NUMBER	SERIAL NUMBER	SERIAL NUMBER
USE	USE	USE
OUTLET 13	OUTLET 14	OUTLET 15
MODEL	MODEL	MODEL
SERIAL NUMBER	SERIAL NUMBER	SERIAL NUMBER
USE	USE	USE

OUTLET 16	OUTLET 17	OUTLET 18
MODEL	MODEL	MODEL
SERIAL NUMBER	SERIAL NUMBER	SERIAL NUMBER
USE	USE	USE
OUTLET 19	OUTLET 20	OUTLET 21
MODEL	MODEL	MODEL
SERIAL NUMBER	SERIAL NUMBER	SERIAL NUMBER
USE	USE	USE

Appendix B: Equipment Setup Worksheet

OUTLET 22	OUTLET 23	OUTLET 24
MODEL	MODEL	MODEL
SERIAL NUMBER	SERIAL NUMBER	SERIAL NUMBER
USE	USE	USE

Types of adapters

Types of cables

Name of software program

Appendix C Configuration or Firmware Upgrade with a USB Drive

You can accomplish part or all of the following tasks simultaneously by plugging a USB flash drive which contains one or several special configuration files into the PX3.

- Configuration changes
- Firmware upgrade
- Downloading diagnostic data

*Tip: You can also accomplish the same tasks via the TFTP server in a DHCP network. See **Bulk Configuration or Firmware Upgrade via DHCP/TFTP** (on page 562).*

In This Chapter

Device Configuration/Upgrade Procedure.....	548
System and USB Requirements.....	549
Configuration Files.....	550
Firmware Upgrade via USB.....	560

Device Configuration/Upgrade Procedure

You can use one USB drive to configure or upgrade multiple PX3 devices one by one as long it contains valid configuration files.

- ▶ **To use a USB drive to configure the PX3 or upgrade firmware:**
 1. Verify that both the USB drive and your PX3 meet the requirements. See **System and USB Requirements** (on page 549).
 2. Prepare required configuration files. See **Configuration Files** (on page 550).
 3. Copy required configuration files to the root directory of the USB drive.
 - For firmware upgrade, an appropriate firmware binary file is also required.
 4. Plug the USB drive into the USB-A port of the PX3.
 5. The initial message shown on the front panel display depends on the first task performed by the PX3.
 - If no firmware upgrade task will be performed, a happy smiley is displayed after around 30 seconds.

The happy smiley looks like one of the following, depending on your Raritan product.

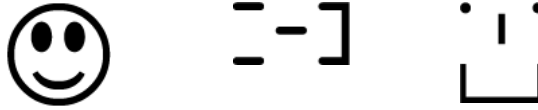

- If the USB drive contains the firmware upgrade data, the PX3:
 - a. First performs the firmware upgrade, showing the upgrade message on the front panel display.
 - b. Then shows the happy smiley when the firmware upgrade completes successfully. See *Firmware Upgrade via USB* (on page 560).
- 6. After the happy smiley appears, press one of the control buttons next to the display for one second until the smiley disappears.

Tip: You can remove the USB drive and plug it into another PX3 for performing the same task(s) once the happy smiley or the firmware upgrade message displays.

7. Wait for several seconds until the PX3 resumes normal operation, indicated by the normal message of the display.

If nothing is shown on the display and no task is performed after plugging the USB drive, check the log file in the USB drive.

System and USB Requirements

You must satisfy ALL of the following requirements prior to using a USB flash drive to perform device configuration and/or firmware upgrade.

▶ **PX3 system requirements:**

- There is at least one USB-A port available on your Raritan device.
- Your PX3 must be version 2.2.13 or later.

Note that the PX3 interpreted the USB drive's contents using the firmware which was running when plugging the USB drive, not the new firmware after firmware upgrade.

▶ **USB drive requirements:**

- The drive contains either a single partition formatted as a Windows FAT32 filesystem, or NO partition tables (that is, a superfloppy-formatted drive).
- The drive contains a configuration file called *fwupdate.cfg* in its root directory. See *fwupdate.cfg* (on page 551).

Configuration Files

There are three types of configuration files.

- **fwupdate.cfg:**
This file MUST be always present for performing configuration or firmware upgrade tasks. See *fwupdate.cfg* (on page 551).
 - **config.txt:**
This file is used for configuring device settings. See *config.txt* (on page 555).
 - **devices.csv:**
This file is required only when there are device-specific settings to configure for multiple PX3 devices. See *devices.csv* (on page 557).
- Raritan provides a Mass Deployment Utility, which helps you to quickly generate all configuration files for your PX3. See *Creating Configuration Files via Mass Deployment Utility* (on page 558).

fwupdate.cfg

The configuration file, *fwupdate.cfg*, is an ASCII text file containing key-value pairs, one per line.

Each value in the file must be separated by an equal sign (=), without any surrounding spaces. Keys are not case sensitive.

Illustration:

```
user=admin
password=raritan
logfile=log.txt
config=config.txt
device_list=devices.csv
```

This section only explains common options in the file.

Note: To use any options developed after version 2.2.13, the firmware version running on your PX3 must be able to support them.

▶ **user**

- A required option.
- Specify the name of a user account with Administrator Privileges.
- For a PX3 with factory default configuration, set this option to `admin`.

▶ **password**

- A required option.
- Specify the password of the specified admin user.
- For a PX3 with factory default configuration, set this option to `raritan`.

▶ **logfile**

- Specify the name of a text file where the PX3 will append the log messages when interpreting the USB drive contents.
- If the specified file does not exist in the USB drive, it will be automatically created.
- If this option is not set, no log message are recorded. The disadvantage is that no feedback is available if the PX3 detects a problem with the USB drive contents.

▶ **firmware**

- Specify the name of a firmware binary file used to upgrade your PX3.
- The specified firmware file must be compatible with your PX3 and have an official Raritan signature.

- If the specified firmware file is the same as the current firmware version of your PX3, no firmware upgrade is performed unless you have set the option "force_update" to `true`.

▶ **force_update**

- If this option is set to `true`, the firmware upgrade is always performed even though your PX3 is running the same firmware version as the specified firmware file.
- This option CANNOT break other constraints like the minimum downgrade version.

▶ **config**

- Supported as of release 2.4.0.
- Specify the name of the configuration file containing device settings.
- The suggested filename is `config.txt`. See ***config.txt*** (on page 555).

▶ **device_list**

- Specify the name of the configuration file listing all PX3 devices to configure and their device-specific settings.
- This file is required if any macros are used in the device configuration file "config.txt."
- The suggested filename is `devices.csv`. See ***devices.csv*** (on page 557).

▶ **match**

- Specify a match condition for identifying a line or a PX3 device in the device configuration file "devices.csv."

The option's value comprises one word and one number as explained below:

- The word prior to the colon is an identification property, which is either `serial` for serial number or `mac` for MAC address.
- The number following the colon indicates a column in the `devices.csv` file.

For example, `mac:7` instructs the PX3 to search for the MAC address in the 7th column of the "devices.csv" file.

- The default value is `serial:1`, making the PX3 search for its serial number in the first column.
- This option is used only if the "device_list" option has been set.

▶ **collect_diag**

- If this option is set to `true`, the diagnostic data of the PX3 is downloaded to the USB drive.
- The filename of the diagnostic data written into the USB drive varies, depending on the PX3 firmware version:
 - Filename prior to version 3.0.0: `diag_<unit-serial>.zip`, where `<unit-serial>` is the serial number of the PX3.
 - Filename as of version 3.0.0: `diag_<unit-serial>.tgz`
- The PX3 utters a short beep when writing the diagnostic data to the USB drive.

▶ **factory_reset**

- Supported as of release 3.0.0.
- If this option is set to `true`, the PX3 will be reset to factory defaults.
- If the device configuration will be updated at the same time, the factory reset will be executed before updating the device configuration.

▶ **bulk_config_restore**

- Supported as of release 3.1.0.
- Specify the name of the bulk configuration file used to configure or restore the PX3.

*Note: See **Bulk Configuration** (on page 344) for instructions on generating a bulk configuration file.*

- Additional configuration keys set via the `config.txt` file will be applied after performing the bulk restore operation.
- This option CANNOT be used with the option "full_config_restore."
- If a firmware upgrade will be performed at the same time, you must generate the bulk configuration file based on the NEW firmware version instead of the current firmware version.

▶ **full_config_restore**

- Supported as of release 3.1.0.
- Specify the name of the full configuration backup file used to restore the PX3.

*Note: See **Backup and Restore of Device Settings** (on page 347) for instructions on generating the full configuration backup file.*

- Additional configuration keys set via the *config.txt* file will be applied after performing the configuration restore operation.
- This option CANNOT be used with the option "bulk_config_restore."
- If a firmware upgrade will be performed at the same time, you must generate the full configuration backup file based on the NEW firmware version instead of the current firmware version.

▶ **execute_lua_script**

- Supported as of release 3.3.0.
- Specify a LUA binding script file. For example:
`execute_lua_script=my_script.lua`
- Script output will be recorded to a log file -- `<BASENAME_OF_SCRIPT>.<SERIAL_NUMBER>.log`. Note this log file's size is limited on dhcp/tftp.
- A dhcp/tftp-located script has a timeout of 60 seconds. After that duration the script will be removed.
- If you unplug the USB drive while the LUA script is still running, the script will be removed.
- An exit handler can be used but the execution time is limited to three seconds. Note that this is not implemented on dhcp/tftp yet.
- This feature can be used to manage LuaService, such as upload, start, get output, and so on.

config.txt

To perform device configuration using a USB drive, you must:

- Copy the device configuration file "config.txt" to the root directory of the USB drive.
- Reference the "config.txt" file in the *config* option of the "fwupdate.cfg" file. See *fwupdate.cfg* (on page 551).

The file, *config.txt*, is a text file containing a number of configuration keys and values to configure or update.

This section only introduces the device configuration file in brief, and does not document all configuration keys, which vary according to the firmware version and your PX3 model.

You can use Raritan's Mass Deployment Utility to create this file by yourself, or contact Raritan to get a device configuration file specific to your PX3 model and firmware version.

*Tip: As of release 3.2.20, you can choose to encrypt important data in the "config.txt" file so that people cannot easily recognize it, such as the SNMP write community string. See **Data Encryption in 'config.txt'** (on page 559).*

► **Regular configuration key syntax:**

- Each configuration key and value pair is in a single line as shown below:

```
key=value
```

Note: Each value in the file must be separated by an equal sign (=), without any surrounding spaces.

- As of release 3.1.0, multi-line values are supported by using the *Here Document Syntax* with a user-chosen delimiter.

The following illustration declares a value in two lines. You can replace the delimiter EOF with other delimiter strings.

```
key<<EOF
value line 1
value line 2
EOF
```

Note: The line break before the closing EOF is not part of the value. If a line break is required in the value, insert an additional empty line before the closing EOF.

► **Special configuration keys:**

There are 3 special configuration keys that are prefixed with `magic:`.

- A special key that sets a user account's password without knowing the firmware's internal encryption/hashing algorithms is implemented as of release 2.2.13.

Example:

```
magic:users[1].cleartext_password=joshua
```

- Two special keys that set the SNMPv3 passphrases without knowing the firmware's internal encryption/hashing algorithms are implemented as of release 2.4.0.

Examples:

```
magic:users[1].snmp_v3.auth_phrase=swordfish
magic:users[1].snmp_v3.priv_phrase=opensesame
```

► **To configure device-specific settings:**

1. Make sure the device list configuration file "devices.csv" is available in the USB drive. See *devices.csv* (on page 557)
2. In the "config.txt" file, refer each device-specific configuration key to a specific column in the "devices.csv" file. The syntax is: `${column}`, where "column" is a column number.

Examples:

```
network.interfaces[eth0].ipaddr=${2}
pdu.name=${16}
```

► **To rename the admin user:**

As of release 3.1.0, you can rename the admin user by adding the following configuration key:

```
users[0].name=new admin name
```

Example:

```
users[0].name=May
```

devices.csv

If there are device-specific settings to configure, you must create a device list configuration file - *devices.csv*, to store unique data of each PX3.

This file must be:

- An excel file in the CSV format.
- Copied to the root directory of the USB drive.
- Referenced in the *device_list* option of the "fwupdate.cfg" file. See *fwupdate.cfg* (on page 551).

Every PX3 identifies its entry in the "devicelist.csv" file by comparing its serial number or MAC address to one of the columns in the file.

▶ **Determine the column to identify PX3 devices:**

- By default, a PX3 searches for its serial number in the 1st column.
- To override the default, set the *match* option in the "fwupdate.cfg" file to a different column.

▶ **Syntax:**

- Prior to release 3.1.0, only single-line values containing NO commas are supported. A comma is considered a field delimiter.

For example:

```
Value-1,Value-2,Value-3
```

- As of release 3.1.0, values containing commas, line breaks or double quotes are all supported. The commas and line breaks to be included in the values must be enclosed in double quotes. Every double quote to be included in the value must be escaped with another double quote.

For example:

```
Value-1, "Value-2,with,three,commas" ,Value-3
```

```
Value-1, "Value-2, " "with" "three" "double-quotes" ,Value-3
```

```
Value-1, "Value-2  
with a line break" , Value-3
```

Creating Configuration Files via Mass Deployment Utility

The Mass Deployment Utility is an Excel file that lets you fill in basic information required for the three configuration files, such as the admin account and password.

After entering required information, you can generate all configuration files with only one click, including *fwupdate.cfg*, *config.txt* and *devices.csv*.

► To use the Mass Deployment Utility:

1. Download the Mass Deployment Utility from the Raritan website.
 - The utility is named *mass_deployment-xxx* (where xxx is the firmware version number).
 - It is available on the PX3 section of the **Support page** (<http://www.raritan.com/support/>).

2. Launch Excel to open this utility.

Note: Other office suites, such as OpenOffice and LibreOffice, are not supported.

3. Read the instructions in the 1st worksheet of the utility, and make sure Microsoft Excel's security level has been set to Medium or the equivalent for executing unsigned macros of this utility.
4. Enter information in the 2nd and 3rd worksheets.
 - The 2nd worksheet contains information required for *fwupdate.cfg* and *config.txt*.
 - The 3rd worksheet contains device-specific information for *devices.csv*.
5. Return to the 2nd worksheet to execute the export macro.
 - a. In the Target Directory field, specify the folder where to generate the configuration files. For example, you can specify the root directory of a connected USB drive.
 - b. Click Export Lists to generate configuration files.

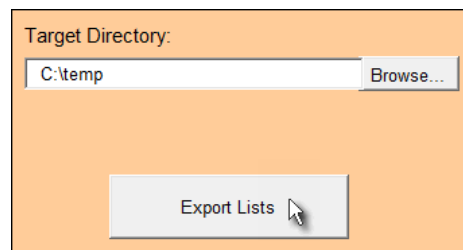

6. Verify that at least 3 configuration files are created - *fwupdate.cfg*, *config.txt* and *devices.csv*. You are ready to configure or upgrade any PX3 with these files. See **Configuration or Firmware Upgrade with a USB Drive** (on page 548).

Data Encryption in 'config.txt'

Encryption for any settings in the file "config.txt" is supported as of release 3.2.20.

When intending to prevent people from identifying the values of any settings, you can encrypt them. Encrypted data still can be properly interpreted and performed by any PX3 running firmware version 3.2.20 or later.

► Data encryption procedure:

1. Open the "config.txt" file to determine which setting(s) to encrypt.
 - If an appropriate "config.txt" is not created yet, see **Creating Configuration Files via Mass Deployment Utility** (on page 558).
2. Launch a terminal to log in to the CLI of any PX3 running version 3.2.20 or later. See **Logging in to CLI** (on page 366).
3. Type the encryption command and the value of the setting you want to encrypt.
 - The value *cannot* contain any double quotes (") or backslashes (-).
 - If the value contains spaces, it must be enclosed in double quotes.

```
# config encrypt <value>
```

-- OR --

```
# config encrypt "<value with spaces>"
```
4. Press Enter. The CLI generates and displays the encrypted form of the typed value.
5. Go to the "config.txt" file and replace the chosen value with the encrypted one by typing or copying the encrypted value from the CLI.
6. Add the text "encrypted:" to the beginning of the encrypted setting.
7. Repeat steps 3 to 6 for additional settings you intend to encrypt.
8. Save the changes made to the "config.txt" file. Now you can use this file to configure any PX3 running version 3.2.20 or later. See **Configuration or Firmware Upgrade with a USB Drive** (on page 548).

► **Illustration:**

In this example, we will encrypt the word "private", which is the value of the SNMP write community in the "config.txt" file.

```
snmp.write_community=private
```

1. In the CLI, type the following command to encrypt "private."

```
# config encrypt private
```

2. The CLI generates and shows the encrypted form of "private."

```
ZTtnYcvQUw==
```

3. In the "config.txt" file, make the following changes to the SNMP write community setting.
 - a. Replace the word "private" with the encrypted value that CLI shows.

```
snmp.write_community=ZTtnYcvQUw==
```

- b. Add "encrypted:" to the beginning of that setting.

```
encrypted:snmp.write_community=ZTtnYcvQUw==
```

Firmware Upgrade via USB

Firmware files are available on Raritan website's *Support page* (<http://www.raritan.com/support/>).

Note that if the firmware file used for firmware upgrade is the same as the firmware version running on the PX3, no firmware upgrade will be performed unless you have set the *force_update* option to true in the "fwupdate.cfg" file. See *fwupdate.cfg* (on page 551).

► **To use a USB drive to upgrade the PX3:**

1. Copy the configuration file "fwupdate.cfg" and an appropriate firmware file to the root directory of the USB drive.
2. Reference the firmware file in the *image* option of the "fwupdate.cfg" file.
3. Plug the USB drive into the USB-A port on the PX3.

4. The PX3 performs the firmware upgrade.
 - The front panel display shows the firmware upgrade progress.

Tip: You can remove the USB drive and plug it into another PX3 for firmware upgrade when the firmware upgrade message displays.

5. It may take one to five minutes to complete the firmware upgrade, depending on your product.
6. When the firmware upgrade finishes, the front panel display indicates the firmware upgrade result.

- **Happy smiley:** Successful.

Depending on your product, the happy smiley looks like one of the following.

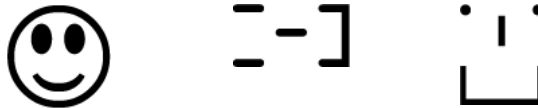

- **Sad smiley:** Failed. Check the log file in the USB drive or contact Raritan Technical Support to look into the failure cause.

The sad smiley looks like one of the following.

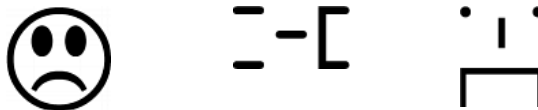

Appendix D Bulk Configuration or Firmware Upgrade via DHCP/TFTP

If a TFTP server is available, you can use it and appropriate configuration files to perform any or all of the following tasks for a large number of PX3 devices in the same network.

- Initial deployment
- Configuration changes
- Firmware upgrade
- Downloading diagnostic data

This feature is drastically useful if you have hundreds or even thousands of PX3 devices to configure or upgrade.

Warning: The feature of bulk configuration or firmware upgrade via DHCP/TFTP only works on standalone PX3 devices directly connected to the network. This feature does NOT work for slave devices in the USB-cascading configuration.

*Tip: For the other alternative, see **Configuration or Firmware Upgrade with a USB Drive** (on page 548).*

In This Chapter

Bulk Configuration/Upgrade Procedure	562
TFTP Requirements	563
DHCP IPv4 Configuration in Windows	564
DHCP IPv6 Configuration in Windows	574
DHCP IPv4 Configuration in Linux	581
DHCP IPv6 Configuration in Linux	583

Bulk Configuration/Upgrade Procedure

The DHCP/TFTP feature is supported as of release 3.1.0 so make sure that all PX3 devices which you want to configure or upgrade are running firmware version 3.1.0 or later.

► **Steps of using DHCP/TFTP for bulk configuration/upgrade:**

1. Create configuration files specific to your PX3 models and firmware versions. See **Configuration Files** (on page 550) or contact Raritan Technical Support to properly prepare some or all of the following files:
 - *fwupdate.cfg* (always required)

- *config.txt*
- *devices.csv*

Note: Supported syntax of "fwupdate.cfg" and "config.txt" may vary based on different firmware versions. If you have existing configuration files, it is suggested to double check with Raritan Technical Support for the correctness of these files prior to using this feature.

2. Configure your TFTP server properly. See **TFTP Requirements** (on page 563).
3. Copy ALL required configuration files into the TFTP root directory. If the tasks you will perform include firmware upgrade, an appropriate firmware binary file is also required.
4. Properly configure your DHCP server so that it refers to the file "fwupdate.cfg" on the TFTP server for your PX3.
Click one or more of the following links for detailed DHCP configuration instructions, based on your system and the IP address type.
 - **DHCP IPv4 Configuration in Windows** (on page 564)
 - **DHCP IPv6 Configuration in Windows** (on page 574)
 - **DHCP IPv4 Configuration in Linux** (on page 581)
 - **DHCP IPv6 Configuration in Linux** (on page 583)
5. Make sure all of the desired PX3 devices use DHCP as the IP configuration method and have been *directly* connected to the network.
6. Re-boot these PX3 devices. The DHCP server will execute the commands in the "fwupdate.cfg" file on the TFTP server to configure or upgrade those PX3 devices supporting DHCP in the same network. DHCP will execute the "fwupdate.cfg" commands once for IPv4 and once for IPv6 respectively if both IPv4 and IPv6 settings are configured properly in DHCP.

TFTP Requirements

To perform bulk configuration or firmware upgrade successfully, your TFTP server must meet the following requirements:

- The server is able to work with both IPv4 and IPv6.

In Linux, remove any IPv4 or IPv6 flags from */etc/xinetd.d/tftp*.

Note: DHCP will execute the "fwupdate.cfg" commands once for IPv4 and once for IPv6 respectively if both IPv4 and IPv6 settings are configured properly in DHCP.

- All required configuration files are available in the TFTP root directory. See *Bulk Configuration/Upgrade Procedure* (on page 562).

If you are going to upload any PX3 diagnostic file or create a log file in the TFTP server, the first of the following requirements is also required.

- The TFTP server supports the write operation, including file creation and upload.

In Linux, provide the option "-c" for write support.

- **Required for uploading the diagnostic file only** - the timeout for file upload is set to one minute or larger.

DHCP IPv4 Configuration in Windows

For those PX3 devices using IPv4 addresses, follow this procedure to configure your DHCP server. The following illustration is based on Microsoft® Windows Server 2012 system.

► Required Windows IPv4 settings in DHCP:

1. Add a new vendor class for Raritan PX3 under IPv4.
 - a. Right-click the IPv4 node in DHCP to select Define Vendor Classes.
 - b. Click Add to add a new vendor class.

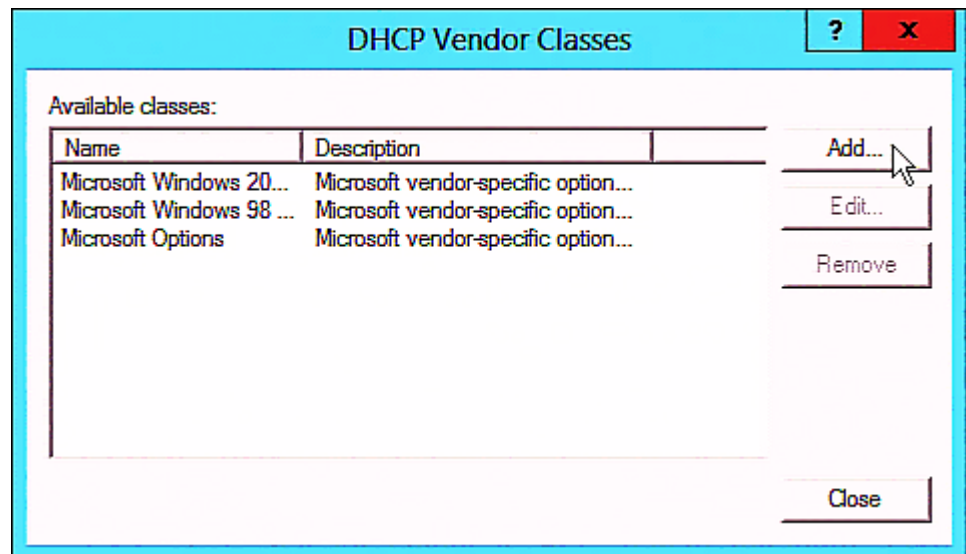

- c. Specify a unique name for this vendor class and type the binary codes of "Raritan PDU 1.0" in the New Class dialog.

The vendor class is named "Raritan PDU" in this illustration.

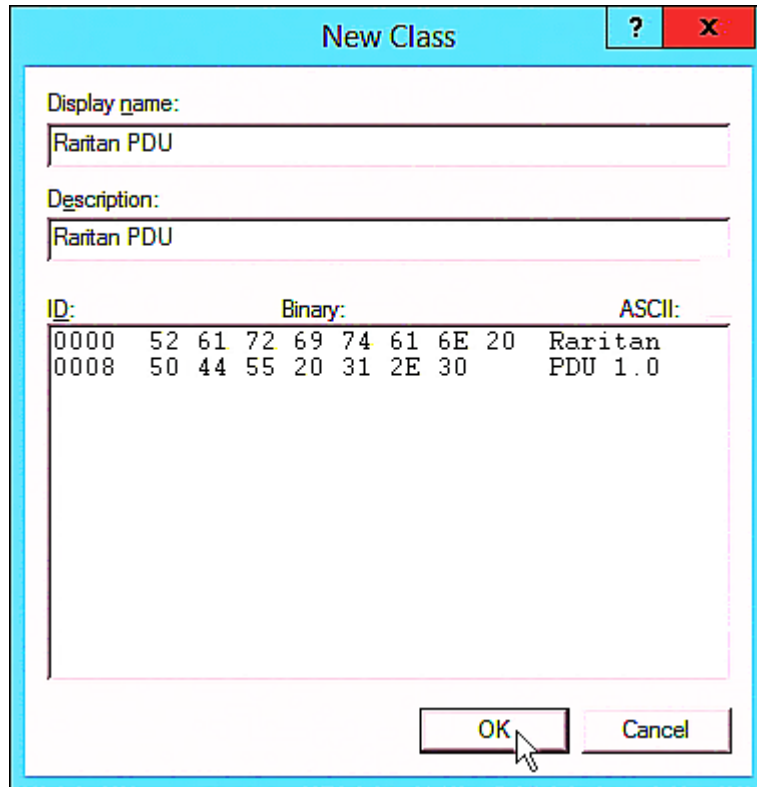

2. Define one DHCP standard option - Vendor Class Identifier.
 - a. Right-click the IPv4 node in DHCP to select Set Predefined Options.

- b. Select DHCP Standard Options in the "Option class" field, and Vendor Class Identifier in the "Option name" field. Leave the String field blank.

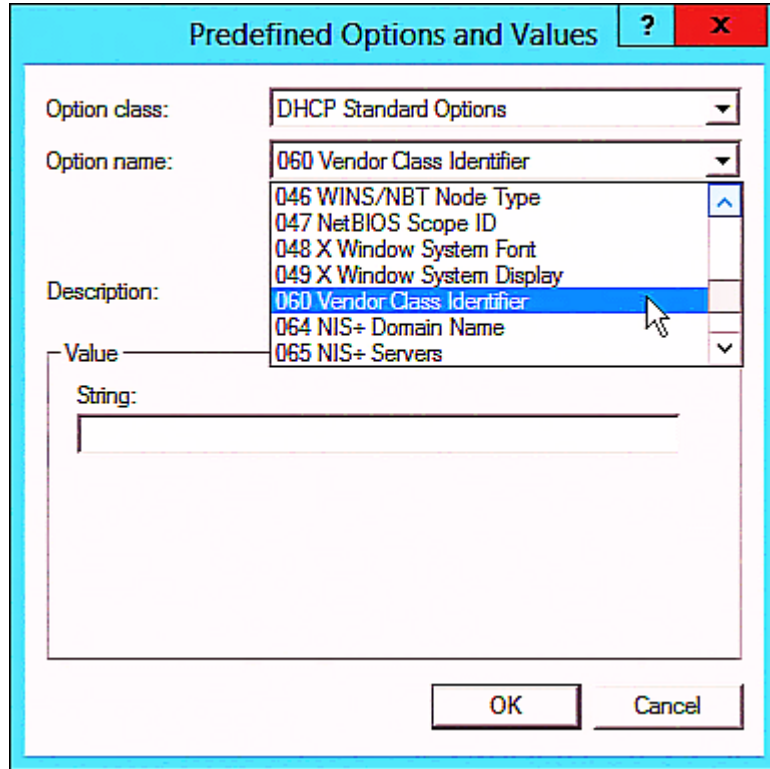

- 3. Add three options to the new vendor class "Raritan PDU" in the same dialog.

- a. Select Raritan PDU in the "Option class" field.

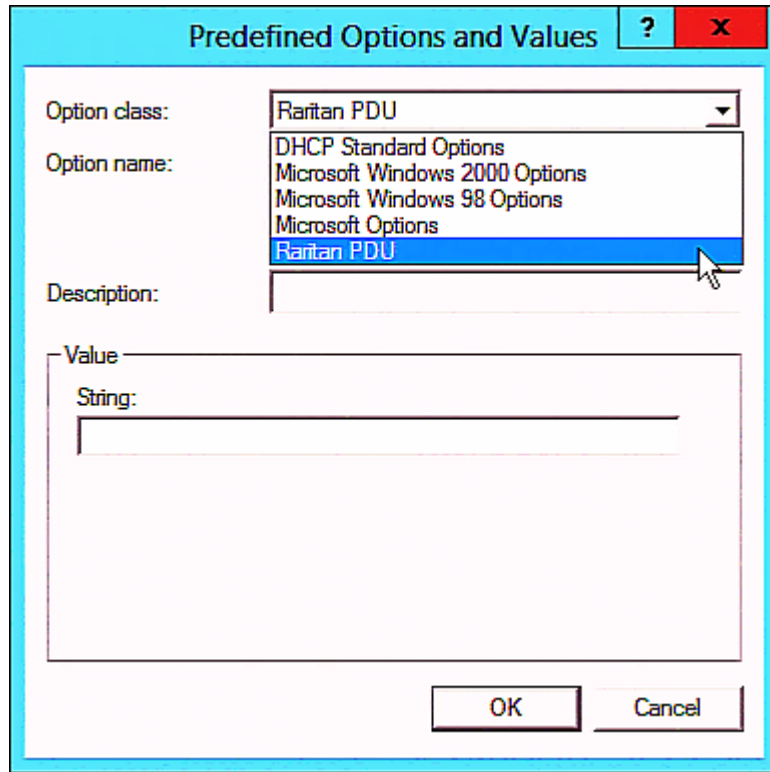

- b. Click Add to add the first option. Type "pdu-tftp-server" in the Name field, select IP Address as the data type, and type 1 in the Code field.

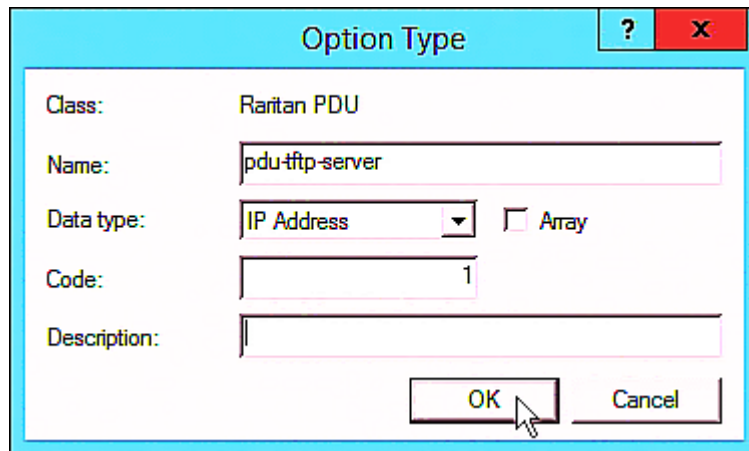

- c. Click Add to add the second option. Type "pdu-update-control-file" in the Name field, select String as the data type, and type 2 in the Code field.

The screenshot shows a dialog box titled "Option Type" with a blue header bar containing a question mark and a close button (X). The dialog contains the following fields:

- Class:** Raritan PDU
- Name:** pdu-update-control-file
- Data type:** String (selected in a dropdown menu), with an unchecked checkbox for Array.
- Code:** 2
- Description:** (empty text box)

At the bottom right, there are two buttons: "OK" and "Cancel". A mouse cursor is pointing at the "OK" button.

- d. Click Add to add the third one. Type "pdu-update-magic" in the Name field, select String as the data type, and type 3 in the Code field.

The screenshot shows a dialog box titled "Option Type" with a blue header bar containing a question mark and a close button (X). The dialog contains the following fields:

- Class:** Raritan PDU
- Name:** pdu-update-magic
- Data type:** String (selected in a dropdown menu), with an unchecked checkbox for Array.
- Code:** 3
- Description:** (empty text box)

At the bottom right, there are two buttons: "OK" and "Cancel". A mouse cursor is pointing at the "OK" button.

4. Create a new policy associated with the "Raritan PDU" vendor class.
 - a. Right-click the Policies node under IPv4 to select New Policy.
 - b. Specify a policy name, and click Next.

The policy is named "PDU" in this illustration.

DHCP Policy Configuration Wizard

Policy based IP Address and Option Assignment

This feature allows you to distribute configurable settings (IP address, DHCP options) to clients based on certain conditions (e.g. vendor class, user class, MAC address, etc.).

This wizard will guide you setting up a new policy. Provide a name (e.g. VoIP Phone Configuration Policy) and description (e.g. NTP Server option for VoIP Phones) for your policy.

Policy Name:

Description:

< Back Next > Cancel

c. Click Add to add a new condition.

- d. Select the vendor class "Raritan PDU" in the Value field, click Add and then Ok.

Add/Edit Condition ? X

Specify a condition for the policy being configured. Select a criteria, operator and values for the condition.

Criteria: Vendor Class

Operator: Equals

Value(s)

Value: Raritan PDU Add

Prefix wildcard(*)

Append wildcard(*)

Raritan PDU Remove

Ok Cancel

- e. Click Next.

- f. Select DHCP Standard Options in the "Vendor class" field, select "060 Vendor Class Identifier" from the Available Options list, and type "Raritan PDU 1.0" in the "String value" field.

DHCP Policy Configuration Wizard

Configure settings for the policy
If the conditions specified in the policy match a client request, the settings will be applied.

Vendor class:

Available Options	Description	
<input type="checkbox"/> 049 X Window System Display	Array of X Windows Display M...	^
<input checked="" type="checkbox"/> 060 Vendor Class Identifier		
<input type="checkbox"/> 064 NIS+ Domain Name	The name of the client's NIS+	v

< III >

Data entry

String value:

< Back Next > Cancel

- g. Select the "Raritan PDU" in the "Vendor class" field, select "001 pdu-tftp-server" from the Available Options list, and type your TFTP server's IPv4 address in the "IP address" field.

DHCP Policy Configuration Wizard

Configure settings for the policy
If the conditions specified in the policy match a client request, the settings will be applied.

Vendor class:

Available Options	Description
<input checked="" type="checkbox"/> 001 pdu-tftp-server	
<input type="checkbox"/> 002 pdu-update-control-file	
<input type="checkbox"/> 003 pdu-update-magic	

Data entry

IP address:

< Back Next > Cancel

- h. Select "002 pdu-update-control-file" from the Available Options list, and type the filename "fwupdate.cfg" in the "String value" field.

DHCP Policy Configuration Wizard

Configure settings for the policy
If the conditions specified in the policy match a client request, the settings will be applied.

Vendor class:

Available Options	Description
<input checked="" type="checkbox"/> 001 pdu-tftp-server	
<input checked="" type="checkbox"/> 002 pdu-update-control-file	
<input type="checkbox"/> 003 pdu-update-magic	

Data entry

String value:

< Back Next > Cancel

- i. Select "003 pdu-update-magic" from the Available Options list, and type any string in the "String value" field. This third option/code is the magic cookie to prevent the *fwupdate.cfg* commands from being executed repeatedly. It does NOT matter whether the IPv4 magic cookie is identical to or different from the IPv6 magic cookie.

The magic cookie is a string comprising numerical and/or alphabetical digits in any format. In the following illustration diagram, it is a combination of a date and a serial number.

Important: The magic cookie is transmitted to and stored in PX3 at the time of executing the "fwupdate.cfg" commands. The DHCP/TFTP operation is triggered only when there is a mismatch between the magic cookie in DHCP and the one stored in PX3. Therefore, you must modify the magic cookie's value in DHCP when intending to execute the "fwupdate.cfg" commands next time.

DHCP Policy Configuration Wizard

Configure settings for the policy
If the conditions specified in the policy match a client request, the settings will be applied.

Vendor class:

Available Options	Description
<input checked="" type="checkbox"/> 001 pdu-tftp-server	
<input checked="" type="checkbox"/> 002 pdu-update-control-file	
<input checked="" type="checkbox"/> 003 pdu-update-magic	

Data entry

String value:

DHCP IPv6 Configuration in Windows

For those PX3 devices using IPv6 addresses, follow this procedure to configure your DHCP server. The following illustration is based on Microsoft® Windows Server 2012 system.

► **Required Windows IPv6 settings in DHCP:**

1. Add a new vendor class for Raritan PX3 under IPv6.

- a. Right-click the IPv6 node in DHCP to select Define Vendor Classes.
- b. Click Add to add a new vendor class.

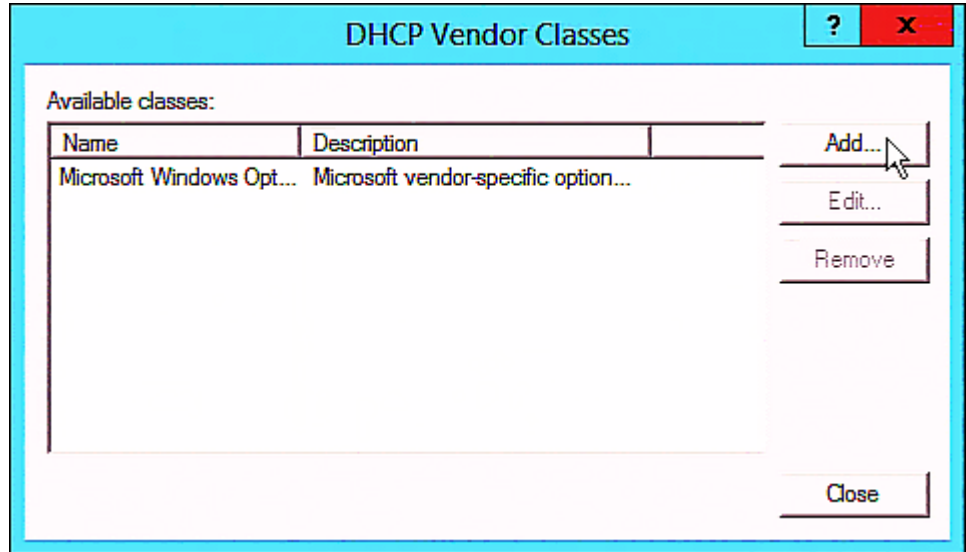

- c. Specify a unique name for the vendor class, type "13742" in the "Vendor ID (IANA)" field, and type the binary codes of "Raritan PDU 1.0" in the New Class dialog.

The vendor class is named "Raritan PDU 1.0" in this illustration.

New Class
?
X

Display name:

Description:

Vendor ID (IANA):

ID:	Binary:	ASCII:
0000	52 61 72 69 74 61 6E 20	Raritan
0008	50 44 55 20 31 2E 30	PDU 1.0

2. Add three options to the "Raritan PDU 1.0" vendor class.
 - a. Right-click the IPv6 node in DHCP to select Set Predefined Options.

- b. Select Raritan PDU 1.0 in the "Option class" field.

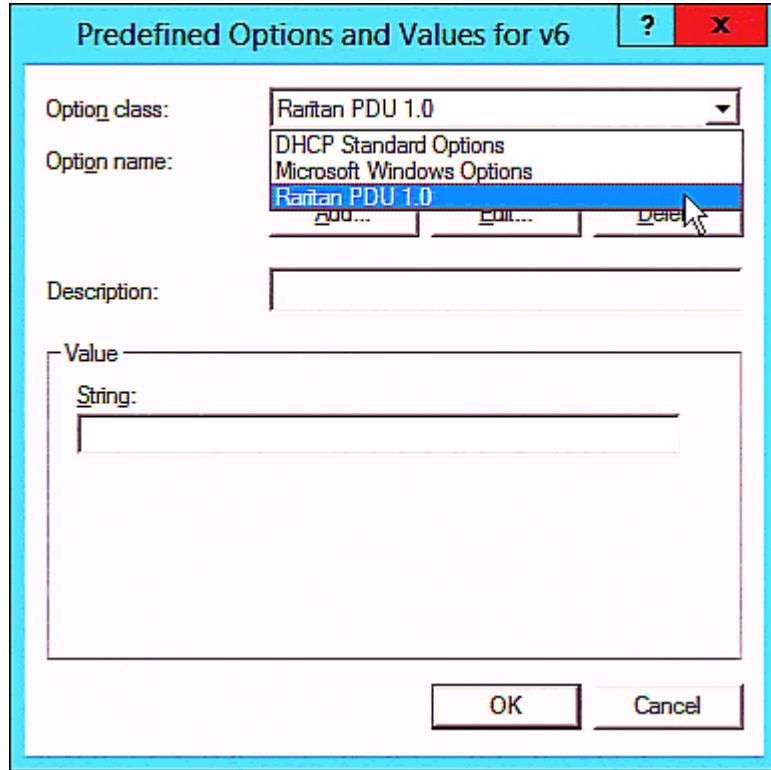

- c. Click Add to add the first option. Type "pdu-tftp-server" in the Name field, select IP Address as the data type, and type 1 in the Code field.

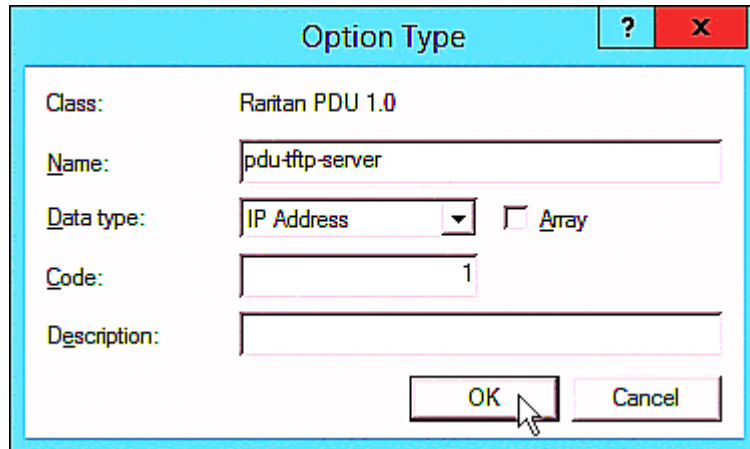

- d. Click Add to add the second option. Type "pdu-update-control-file" in the Name field, select String as the data type, and type 2 in the Code field.

The screenshot shows a dialog box titled "Option Type" with a question mark icon and a close button (X). The form contains the following fields:

- Class:** Raritan PDU 1.0
- Name:** pdu-update-control-file
- Data type:** String (selected in a dropdown menu), with an unchecked checkbox for Array.
- Code:** 2
- Description:** (empty text box)

At the bottom right, there are two buttons: "OK" and "Cancel". A mouse cursor is pointing at the "OK" button.

- e. Click Add to add the third one. Type "pdu-update-magic" in the Name field, select String as the data type, and type 3 in the Code field.

The screenshot shows a dialog box titled "Option Type" with a question mark icon and a close button (X). The form contains the following fields:

- Class:** Raritan PDU 1.0
- Name:** pdu-update-magic
- Data type:** String (selected in a dropdown menu), with an unchecked checkbox for Array.
- Code:** 3
- Description:** (empty text box)

At the bottom right, there are two buttons: "OK" and "Cancel". A mouse cursor is pointing at the "OK" button.

3. Configure server options associated with the "Raritan PDU 1.0" vendor class.
 - a. Right-click the Server Options node under IPv6 to select Configure Options.
 - b. Click the Advanced tab.

- c. Select "Raritan PDU 1.0" in the "Vendor class" field, select "00001 pdu-tftp-server" from the Available Options list, and type your TFTP server's IPv6 address in the "IPv6 address" field.

The screenshot shows a configuration window titled "Server Options" with a light blue header and a red close button. It has two tabs: "General" (selected) and "Advanced".

Under the "General" tab, there are two dropdown menus: "Vendor class" set to "Raritan PDU 1.0" and "User class" set to "Default User Class".

Below these is a table of "Available Options":

Available Options	Description
<input checked="" type="checkbox"/> 00001 pdu-tftp-server	
<input type="checkbox"/> 00002 pdu-update-control-file	
<input type="checkbox"/> 00003 pdu-update-magic	

Below the table is a "Data entry" section with a text field for "IPv6 address" containing the value "fd07:2fa:6cff:1010::200".

At the bottom of the window are three buttons: "OK", "Cancel", and "Apply".

- d. Select "00002 pdu-update-control-file" from the Available Options list, and type the filename "fwupdate.cfg" in the "String value" field.

The screenshot shows the 'Server Options' dialog box with the 'Advanced' tab selected. The 'Vendor class' is set to 'Raritan PDU 1.0' and the 'User class' is 'Default User Class'. The 'Available Options' list contains three entries: '00001 pdu-ftp-server', '00002 pdu-update-control-file' (which is selected and highlighted in blue), and '00003 pdu-update-magic'. Below the list, the 'Data entry' section has a 'String value' field containing the text 'fwupdate.cfg'. At the bottom of the dialog are 'OK', 'Cancel', and 'Apply' buttons.

- e. Select "00003 pdu-update-magic" from the Available Options list, and type any string in the "String value" field. This third option/code is the magic cookie to prevent the *fwupdate.cfg* commands from being executed repeatedly. It does NOT matter whether the IPv6 magic cookie is identical to or different from the IPv4 magic cookie.

The magic cookie is a string comprising numerical and/or alphabetical digits in any format. In the following illustration diagram, it is a combination of a date and a serial number.

Important: The magic cookie is transmitted to and stored in PX3 at the time of executing the "fwupdate.cfg" commands. The DHCP/TFTP operation is triggered only when there is a mismatch between the magic cookie in DHCP and the one stored in PX3. Therefore, you must modify the magic cookie's value in DHCP when intending to execute the "fwupdate.cfg" commands next time.

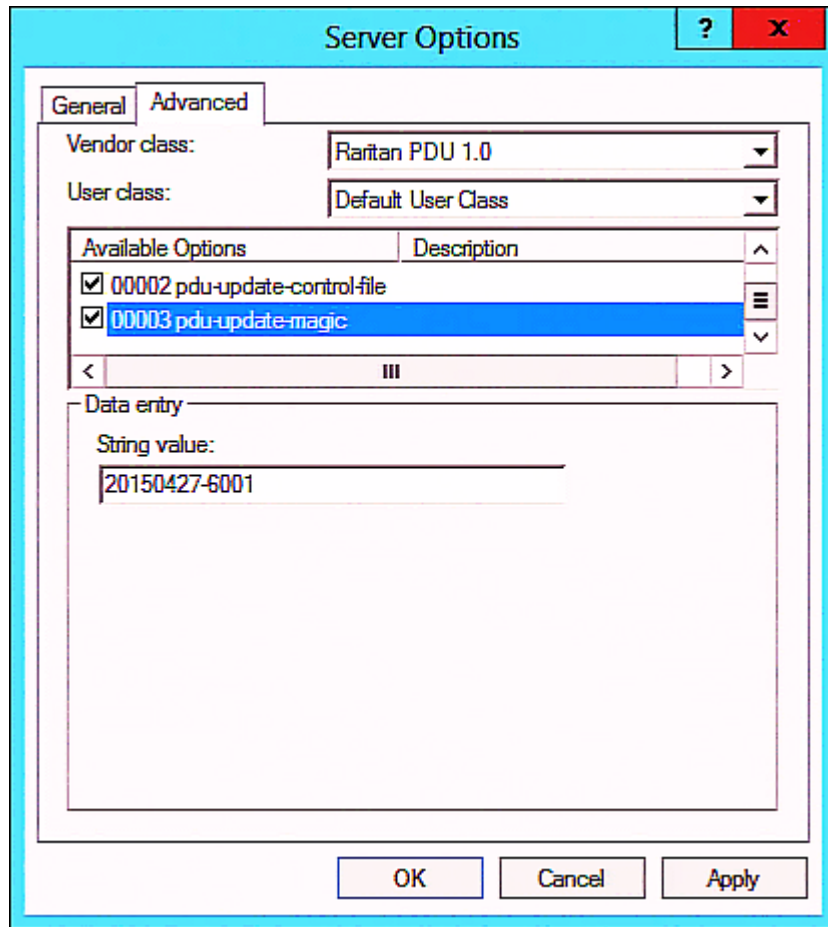

DHCP IPv4 Configuration in Linux

Modify the "dhcpd.conf" file for IPv4 settings when your DHCP server is running Linux.

► **Required Linux IPv4 settings in DHCP:**

1. Locate and open the "dhcpd.conf" file of the DHCP server.
2. The PX3 will provide the following value of the vendor-class-identifier option (option 60).
 - vendor-class-identifier = "Raritan PDU 1.0"

Configure the same option in DHCP accordingly. The PX3 accepts the configuration or firmware upgrade only when this value in DHCP matches.

3. Set the following three sub-options in the "vendor-encapsulated-options" (option 43).
 - code 1 (pdu-tftp-server) = the TFTP server's IPv4 address
 - code 2 (pdu-update-control-file) = the name of the control file "fwupdate.cfg"
 - code 3 (pdu-update-magic) = any string

This third option/code is the magic cookie to prevent the *fwupdate.cfg* commands from being executed repeatedly. It does NOT matter whether the IPv4 magic cookie is identical to or different from the IPv6 magic cookie.

The magic cookie is a string comprising numerical and/or alphabetical digits in any format. In the following illustration diagram, it is a combination of a date and a serial number.

Important: The magic cookie is transmitted to and stored in PX3 at the time of executing the "fwupdate.cfg" commands. The DHCP/TFTP operation is triggered only when there is a mismatch between the magic cookie in DHCP and the one stored in PX3. Therefore, you must modify the magic cookie's value in DHCP when intending to execute the "fwupdate.cfg" commands next time.

► IPv4 illustration example in dhcpd.conf:

```
[...]  
  
set vendor-string = option vendor-class-identifier;  
option space RARITAN code width 1 length width 1 hash size 3;  
option RARITAN.pdu-tftp-server code 1 = ip-address;  
option RARITAN.pdu-update-control-file code 2 = text;  
option RARITAN.pdu-update-magic code 3 = text;  
  
class "raritan" {  
    match if option vendor-class-identifier = "Raritan PDU 1.0";  
    vendor-option-space          RARITAN;  
    option RARITAN.pdu-tftp-server 192.168.1.7;  
    option RARITAN.pdu-update-control-file "fwupdate.cfg";  
    option RARITAN.pdu-update-magic "20150123-0001";  
    option vendor-class-identifier "Raritan PDU 1.0";  
}  
  
[...]
```

DHCP IPv6 Configuration in Linux

Modify the "dhcpd6.conf" file for IPv6 settings when your DHCP server is running Linux.

► **Required Linux IPv6 settings in DHCP:**

1. Locate and open the "dhcpd6.conf" file of the DHCP server.
2. The PX3 will provide the following values to the "vendor-class" option (option 16). Configure related settings in DHCP accordingly.
 - 13742 (Raritan's IANA number)
 - Raritan PDU 1.0
 - 15 (the length of the above string "Raritan PDU 1.0")
3. Set the following three sub-options in the "vendor-opts" (option 17).
 - code 1 (pdu-tftp-server) = the TFTP server's IPv6 address
 - code 2 (pdu-update-control-file) = the name of the control file "fwupdate.cfg"

- code 3 (pdu-update-magic) = any string

This third option/code is the magic cookie to prevent the *fwupdate.cfg* commands from being executed repeatedly. It does NOT matter whether the IPv6 magic cookie is identical to or different from the IPv4 magic cookie.

The magic cookie is a string comprising numerical and/or alphabetical digits in any format. In the following illustration diagram, it is a combination of a date and a serial number.

Important: The magic cookie is transmitted to and stored in PX3 at the time of executing the "fwupdate.cfg" commands. The DHCP/TFTP operation is triggered only when there is a mismatch between the magic cookie in DHCP and the one stored in PX3. Therefore, you must modify the magic cookie's value in DHCP when intending to execute the "fwupdate.cfg" commands next time.

► IPv6 illustration example in *dhcpd6.conf*:

```
[...]

option space RARITAN code width 2 length width 2 hash size 3;
option RARITAN.pdu-tftp-server code 1 = ip6-address;
option RARITAN.pdu-update-control-file code 2 = text;
option RARITAN.pdu-update-magic code 3 = text;
option vsio.RARITAN code 13742 = encapsulate RARITAN;

[...]

subnet6 xxxx {

[...]
    option RARITAN.pdu-tftp-server 1::2;
    option RARITAN.pdu-update-control-file "fwupdate.cfg";
    option RARITAN.pdu-update-magic "20150123-0001";
[...]
}
```

Appendix E Resetting to Factory Defaults

You can use either the reset button or the command line interface (CLI) to reset the PX3.

Important: Exercise caution before resetting the PX3 to its factory defaults. This erases existing information and customized settings, such as user profiles, threshold values, and so on. Only active energy data and firmware upgrade history are retained.

► **Alternative:**

Another method to reset it to factory defaults is to use the web interface. See *Resetting All Settings to Factory Defaults* (on page 350).

In This Chapter

Using the Reset Button	585
Using the CLI Command	586

Using the Reset Button

An RS-232 serial connection to a computer is required for using the reset button.

► **To reset to factory defaults using the reset button:**

1. Connect a computer to the PX3 device. See *Connecting the PX3 to a Computer* (on page 28).
2. Launch a terminal emulation program such as HyperTerminal, Kermit, or PuTTY, and open a window on the PX3. For information on the serial port configuration, see Step 2 of *Initial Network Configuration via CLI* (on page 32).
3. Press (and release) the Reset button of the PX3 device while pressing the Esc key of the keyboard several times in rapid succession. A prompt (=>) should appear after about one second.
4. Type *defaults* to reset the PX3 to its factory defaults.
5. Wait until the Username prompt appears, indicating the reset is complete.

These diagrams illustrate the reset button on Zero U models. Port locations may differ on your models.

- PX3 models:

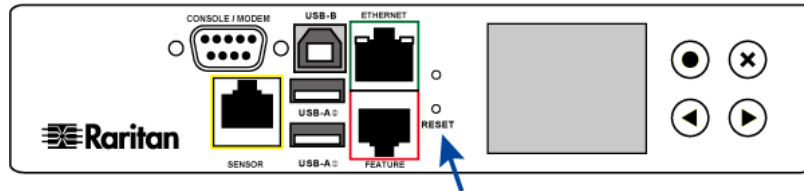

- PX3-iX7 models:

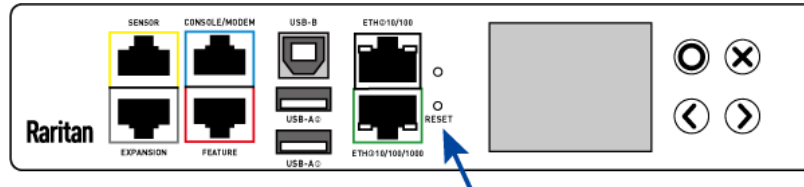

Note: HyperTerminal is available on Windows operating systems prior to Windows Vista. For Windows Vista or later versions, you may use PuTTY, which is a free program you can download from the Internet. See PuTTY's documentation for details on configuration.

Using the CLI Command

The Command Line Interface (CLI) provides a reset command for restoring the PX3 to factory defaults. For information on CLI, see *Using the Command Line Interface* (on page 365).

- ▶ **To reset to factory defaults after logging in to the CLI:**

1. Connect to the PX3 device. See *Logging in to CLI* (on page 366) or *Connecting the PX3 to a Computer* (on page 28).
2. Launch a terminal emulation program such as HyperTerminal, Kermit, or PuTTY, and open a window on the PX3. For information on the serial port configuration, see Step 2 of *Initial Network Configuration via CLI* (on page 32).
3. Log in to the CLI by typing the user name "admin" and its password.
4. After the # system prompt appears, type either of the following commands and press Enter.

```
# reset factorydefaults
```

```
-- OR --
```

```
# reset factorydefaults /y
```

5. If you entered the command without "/y" in Step 4, a message appears prompting you to confirm the operation. Type y to confirm the reset.

6. Wait until the Username prompt appears, indicating the reset is complete.

► **To reset to factory defaults without logging in to the CLI:**

The PX3 provides an easier way to reset the product to factory defaults in the CLI prior to login.

1. Connect to the PX3 and launch a terminal emulation program as described in the above procedure.
2. At the Username prompt in the CLI, type "factorydefaults" and press Enter.

```
Username: factorydefaults
```

3. Type `y` on a confirmation message to perform the reset.

Appendix F PX3 Models with Residual Current Monitoring

PX3 models with residual current monitoring (RCM) detect and report residual current - abnormal flow of current into the protective earth conductor.

Residual current is a safety issue since electrocution is possible if the rack or any device within it is touched.

Warning: PX3 RCM cannot disconnect power to stop residual current flow. Devices like RCD and GFI disconnect power when residual current is detected, but the PX3 with RCM are NOT RCD or GFI protected devices.

In This Chapter

RCM Current Sensor	588
RCM State Sensor	589
Compliance with IEC 62020.....	590
RCM Self-Test	591
Web Interface Operations for RCM	591
Front Panel Operations for RCM.....	594
RCM SNMP Operations	597
CLI Operations for RCM	598

RCM Current Sensor

The RCM current sensor detects current imbalance which indicates current is flowing to ground. The sensor cannot determine the exact location. It just reports the sum of all residual current in the PDU and devices plugged into it.

Most equipment leaks a small amount of current and the UL/IEC 60950-1 standard for IT equipment permits up to 3mA. The RCM reports the sum so if twenty plugged-in devices - each leaking 1mA, the RCM sensor reports 20mA.

Raritan offers two types of RCM sensors.

- Type A: Detects AC leakage and is sensitive down to 6mA leakage. Models ending in -M5.
- Type B: Detects AC and DC leakage and is sensitive down to 30mA. Models ending in -M11.

RCM State Sensor

The RCM state sensor reports events based on residual current thresholds or RCM self-test failure.

RCM state	Description
Normal	Residual current is within normal range.
Warning	Residual current is above warning level.
Critical	Residual current is above critical level. In addition to an event, the CRITICAL state causes the PX3 front panel to display a special error message.
Self-test active	RCM diagnostics are running.
Failure	RCM current sensor has malfunctioned. Contact Raritan Technical Support.

*Note: The factory default is to disable the Warning state. To define and enable this state, see **Setting RCM Current Thresholds** (on page 592).*

Compliance with IEC 62020

IEC 62020 is an international standard for Residual Current Monitors. All PX3 with RCM are IEC 62020 compliant.

IEC 62020 uses the term *rated residual operating current* ($I_{\Delta n}$) to specify residual current, equal to or above which causes an alarm. IEC 62020 recommends preferred values 6mA, 10mA, 30mA, 100mA, 300mA and 500mA. In the PX3 with RCM, $I_{\Delta n}$ is specified using the Critical Rated Residual Operating Current threshold.

Note: The PX3 triggers events when residual current values are above (but not equal to) thresholds. For example, you would set the critical threshold to 29mA to specify the IEC 62020 $I_{\Delta n}$ of 30mA.

IEC 62020 uses the term *residual non-operating current* ($I_{\Delta no}$) to specify residual current, below which does not cause an alarm. IEC 62020 specifies $I_{\Delta no}$ be no higher than 0.5 $I_{\Delta n}$. In PX3 with RCM, $I_{\Delta no}$ is set using the RCM Deassertion Hysteresis and this value must be no higher than 0.5 the RCM critical threshold.

PX3 with RCM allows you to establish an optional WARNING state, which is not part of the IEC 62020 specification. PX3 RCM remains IEC 62020 compliant when the RCM deassertion hysteresis is configured properly.

IEC 62020 specification	PX3 with RCM characteristics
Method of operation	Dependent on line voltage. RCM only functions if line voltage is present.
Type of installation	PX3 with flexible line cords and plugs are for mobile installation and corded connection.
Current paths	1-phase PX3 are two current paths RCM. 3-phase 3W+PE are three current paths RCM. 3-phase 4W+PE are four current paths RCM.
Ability to adjust residual operating current	Adjustable. <ul style="list-style-type: none"> ▪ Type A: 6mA-500mA. ▪ Type B: 30mA-500mA.
Adjustable time delay	Non-adjustable time delay.
Protection against external influence	Enclosed-type RCM.
Method of mounting	Panel board type RCM.
Method of connection	Not associated with mechanical mounting.

IEC 62020 specification	PX3 with RCM characteristics
Connection of load conductors	Monitored line is directly connected.
Fault indicating means	Visual, with other output signals.
Ability to directly discriminate	Directionally non-discriminating.
Rated residual operating current	0.5A (highest value).
Residual currents with direct current components	Model dependent. Models ending in -M5 are Type A, -M11 are Type B.

RCM Self-Test

PX3 with RCM have a built-in self-test feature that performs these functions:

- When residual current is less than 3mA, 15mA is momentarily added to determine whether the low reading is due to a faulty sensor. The residual current added is done in a safe manner which does not run current into ground or pose operator risk.
- The RCM state sensor changes to SELF-TEST and then back to its original state if self-test passes, or to the FAILURE state if self-test fails. These state changes are useful to verify your monitoring systems (SNMP, syslog, or email) are correctly set up to receive PX3 event notifications.

Note: If self-test fails, the FAILURE state persists until another self-test runs and passes.

Web Interface Operations for RCM

The RCM is a PX3 inlet sensor. To view, configure or run self-test, click Inlet in the **Menu** (on page 132).

Checking RCM State and Current

A section titled 'Residual Current Monitor' is available on the Inlet page, showing both the present RCM state and residual current.

► **To check RCM state and current on the Inlet page:**

1. Click Inlet. See **Web Interface Operations for RCM** (on page 591).
2. Locate the Residual Current Monitor section on the Inlet page.

- RCM State: There are five states - normal, warning, critical, self-test active and failure. For more information, see *RCM State Sensor* (on page 589).
- Residual Operating Current: The magnitude of residual current detected.

*Note: To determine the RCM's normal, warning and critical levels, configure the RCM current thresholds. See **Setting RCM Current Thresholds** (on page 592).*

RCM Critical State Alarm

When a PX3 device's RCM enters the Critical state, the PX3 beeps and this alarm is displayed in the Alerted Sensors section of the Dashboard page.

Alerted Sensors (2 Critical, 0 Warned)		
Sensors	Value	State ▲
Inlet I1 Residual Operating Current	0.091 A	▲ above upper critical
Inlet I1 RCM Status		▲ critical

①
②

Number	Description
①	The magnitude of residual current reported by the RCM current sensor.
②	Critical state reported by the RCM state sensor.

*Tip: RCM critical state is also indicated on the Inlet page or the Internal Beeper section of the PDU page. See **Checking RCM State and Current** (on page 591) or **Internal Beeper State** (on page 148).*

Setting RCM Current Thresholds

The RCM current thresholds define the critical, warning and normal range of residual current.

► **To configure the RCM current thresholds and run self-test:**

1. Click Inlet to open the Inlet page.
2. In the Residual Current Monitor section, click Setup.

3. Set up RCM thresholds.

- a. Enable or disable the RCM critical threshold. Residual current greater than this value triggers Critical RCM state.
 - b. Enable or disable the RCM warning threshold. Residual current greater than this value triggers Warning RCM state.
 - c. Determine the residual current decrease to end Warning or Critical RCM state.
 - d. Click Save.
4. Click 'Start Self Test' to run RCM self-test.

Scheduling RCM Self-Test

You can have the PX3 run RCM self-test automatically at a regular time interval or on a specific date and time. See *Scheduling an Action* (on page 306) for the procedure and select "Start residual current monitor self test" to create the scheduled RCM self-test action.

Disabling or Enabling Front Panel RCM Self-Test

You can enable or disable the function of performing the RCM self-test by operating the front panel buttons. By default, this function is enabled.

► **To disable or enable the front panel RCM self-test:**

1. Choose Device Settings > Front Panel.
2. Do either below:
 - To disable this function, deselect the "Perform RCM self-test" checkbox.
 - To enable this function, select the "Perform RCM self-test" checkbox.
3. Click Save.

Front Panel Operations for RCM

The front panel LCD display shows an alarm message when the RCM enters the critical state. Besides, you can operate the LCD display to check the RCM status.

This section introduces the RCM information shown on the dot-matrix LCD display.

*Note: For RCM information shown on the character LCD display of an old PX3 model, see **RCM Information** (on page 618).*

LCD Message for RCM Critical State

In the RCM critical state, the PDU beeps and the LCD display indicates the RCM critical state.

The RCM alarm information continues to display as long as RCM is in a critical state. The top and bottom bars on the display turn red at the same time.

► **RCM alarm information in the critical state:**

- The LCD display shows two types of information for the inlet with the RCM alarm:
 - RCM State: Critical.
 - Residual Current: Residual current value in Amps.

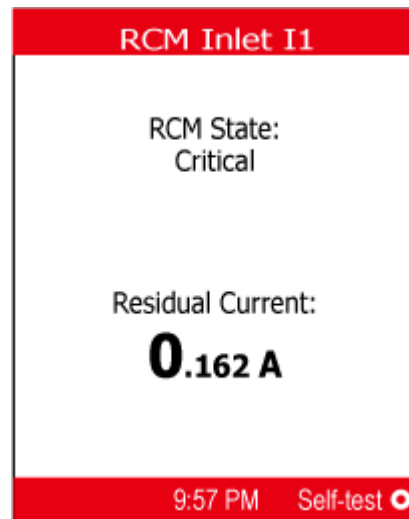





If your PX3 has more than one inlet, only the inlet which has the RCM alarm enters the critical state.

2. If needed, you can press  to perform RCM self-test for this inlet. For details, see steps 4 to 5 in the topic titled *Running RCM Self-Test* (on page 596).

Checking RCM States and Current

You can retrieve RCM information from the LCD display.

► **To check RCM information:**

1. Press  or  to access the *Main Menu* (on page 96).
2. Press  or  to select "Residual Current", and press .
3. The LCD display shows two types of information for Inlet 1.
 - RCM state: Normal or Warning.
 - RCM reading: Residual current value in Amps.

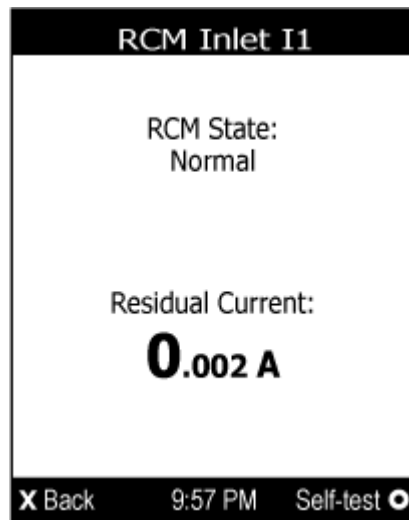

If your PX3 has more than one inlet, a list of inlets is displayed, along with each inlet's RCM state and reading.















4. To return to the Main Menu, press .

Running RCM Self-Test

You can perform the RCM self-test by operating the front panel buttons.

To disable or enable this front panel function, see *Disabling or Enabling Front Panel RCM Self-Test* (on page 593). By default, this function is enabled.

▶ To run RCM self-test:

1. Press  or  to access the *Main Menu* (on page 96).
2. Press  or  to select "Residual Current," and press .
3. The LCD display shows the RCM information for the inlet(s).
4. Press  to perform RCM self-test on the selected inlet.
 - If your PDU has multiple inlets, press  or  to select the desired inlet and press .
5. A confirmation message displays. By default, Yes is selected.
 - To execute the RCM self-test, press .
 - To cancel the RCM self-test, do either of the following:
 - Press .
 - Press  or  to select No and then press .

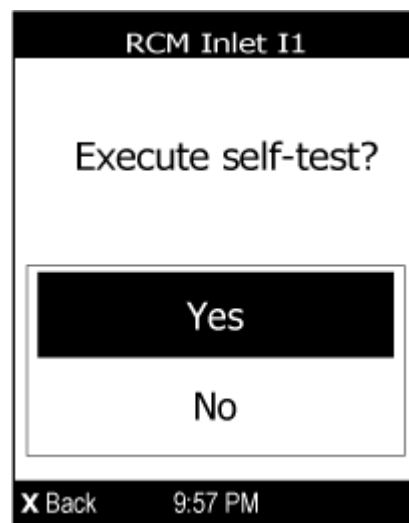

- After completing the RCM self-test, the LCD display indicates the RCM self-test result: passed or failed.

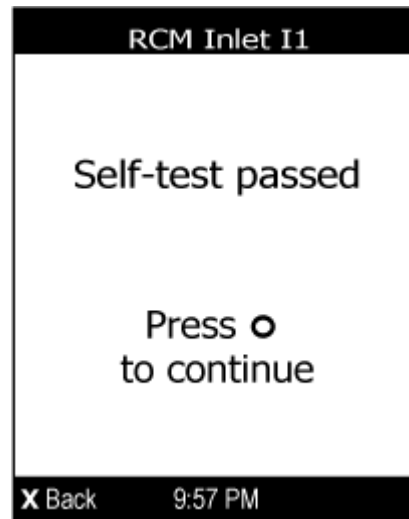

- Press or to return to the RCM information page.
- Do one of the following:
 - To return to the Main Menu, press .
 - To perform RCM self-test for additional inlets, press or to select a different inlet and repeat the same steps.

RCM SNMP Operations

Make sure you have the correct version of SNMP MIB. The PX3 supports the RCM feature as of firmware version 2.5.20. See *Downloading SNMP MIB* (on page 360) for details.

RCM Trap

An *InletSensorStateChange* trap is sent when the RCM state sensor changes. *InletSensorStateChange* is the generic trap sent for all inlet sensors. The specific trap for RCM has the object *typeOfSensor* set to 27. Included with the trap are *measurementsInletSensorValue* (the residual current value) and *measurementsInletSensorState* (the RCM state that caused the trap).

RCM Residual Current and State Objects

The *inletSensorMeasurementsTable* contains entries for RCM residual current and states.

Use index *sensorType* = 26 to retrieve the row for residual current. Column *measurementsInletSensorValue* contains the residual current.

Use index *sensorType* = 27 to retrieve the row for RCM state. Column *measurementsInletSensorState* contains the RCM state enumeration value.

Setting RCM Thresholds

The *inletSensorConfigurationTable* contains a row for configuring RCM thresholds. Use index *sensorType* = 26 to reference the row. Columns *inletSensorUpperWarningThreshold*, *inletSensorUpperCriticalThreshold* and *inletSensorHysteresis* set values for RCM warning, critical and deassertion hysteresis respectively.

Note: The PX3 triggers events when residual current values are above (but not equal to) thresholds. For example, you would set the critical threshold to 29mA to specify the IEC 62020 IΔn of 30mA. See

Compliance with IEC 62020 (on page 590).

Running RCM Self-Test

To initiate RCM self-test using SNMP, set column *rcmState* to value 29 in table *rcmSelfTestTable*.

CLI Operations for RCM

For information on entering and using the CLI, see *Using the Command Line Interface* (on page 365).

Showing Residual Current Monitor Information

This command syntax shows the residual current monitoring (RCM) information, which is only available on the models with RCM. The information displayed include the RCM current, state and thresholds.

```
# show residualCurrentMonitor <n>
```

Variables:

- <n> is one of the options: *all*, or a number.

Option	Description
all	Displays the RCM information of all inlets. <i>Tip: You can also type the command without adding this option "all" to get the same data.</i>
A specific inlet number	Displays the RCM information of the specified inlet only. An inlet number needs to be specified only when there are more than 1 inlet on your PDU.

Setting RCM Current Thresholds

Warning Rated Residual Operating Current is the upper warning threshold of the PX3 RCM sensor, and Critical Rated Residual Operating Current is the upper critical threshold of the RCM sensor. These thresholds are set in the configuration mode. See ***Entering Configuration Mode*** (on page 403).

Note: A residual current sensor's LOWER warning and LOWER critical thresholds do NOT affect the operations of the RCM state sensor so you can ignore them.

► **To configure the RCM's Critical level:**

```
config:# residualCurrentMonitor <n> criticalRatedResidualOperatingCurrent <value>
```

*Note: The PX3 triggers events when residual current values are above (but not equal to) thresholds. For example, you would set the critical threshold to 29mA to specify the IEC 62020 IΔn of 30mA. See **Compliance with IEC 62020** (on page 590).*

► **To configure the RCM's Warning level:**

```
config:# residualCurrentMonitor <n> warningRatedResidualOperatingCurrent <value>
```

► **To configure the RCM's deassertion hysteresis:**

```
config:# residualCurrentMonitor <n> deassertionHysteresis <hy_value>
```

Variables:

- <n> is the number of the inlet where the desired RCM current sensor is mounted. For a single-inlet PDU, this number is always 1.
- <value> is one of the options: *enable*, *disable* or a numeric value measured in amperes.

Option	Description
enable	Enables the specified RCM current threshold for the specified inlet.
disable	Disables the specified RCM current threshold for the specified inlet.
A numeric value	Sets a value for the specified RCM current threshold of the specified inlet and enables this threshold simultaneously. Note that this value is measured in A, not mA. Therefore, to set the value to 6mA, type <i>0.006</i> .

- <hy_value> is a numeric value measured in amperes (A), not milliamperes (mA). For example, to set the value to 15mA, type *0.015*.

Setting Front Panel RCM Self-Test

You can enable or disable the front panel RCM self-test function via CLI in addition to the web interface.

► **To enable the front panel RCM self-test:**

```
# security frontPanelPermissions add rcmSelfTest
```

► **To disable the front panel RCM self-test:**

```
# security frontPanelPermissions remove rcmSelfTest
```

Running RCM Self-Test

You can perform RCM self-test for a specific inlet via CLI. After the self-test finishes, the test result is shown: pass or fail.

▶ **To perform RCM self-test:**

```
#          rcm selfTest inlet <n>
```

Variables:

- <n> is the inlet's number. For a single-inlet PDU, <n> is always 1.

Degaussing RCM Type B Sensors

Only the models with RCM 'Type B' sensors support degaussing the RCM sensors. Those with RCM Type A sensors do NOT support this feature.

You can degauss the RCM sensor after a current surge, such as a short circuit.

▶ **To degauss RCM Type B sensors:**

```
#          rcm degauss
```

Appendix G Old PX3 Character LCD Display

The following diagram shows the front panel on an "old" Zero U PX3 model, which is the first generation of PX3 models.

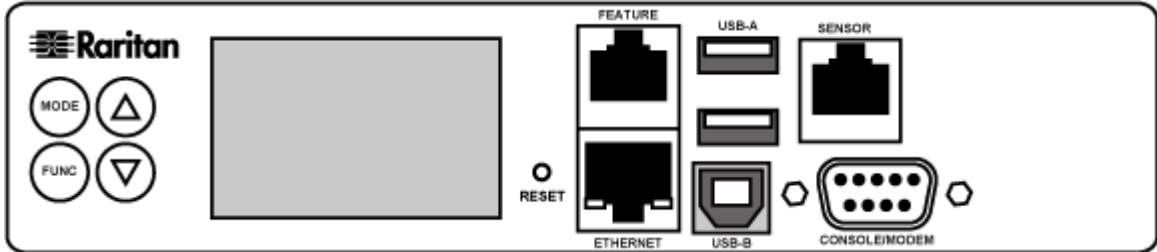

The LCD display on the panel can show the reading or status of different components on the PX3, or its MAC address and IP address.

It consists of:

- A character LCD display
- Control buttons

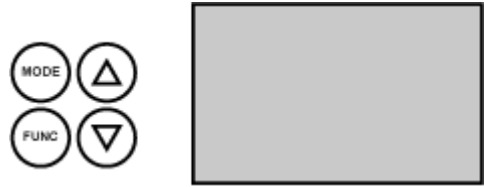

In This Chapter

Overview of the LCD Display	603
Control Buttons	604
Operating the LCD Display	604

Overview of the LCD Display

Different types of information are shown in different sections of the LCD display. The diagram indicates the sections.

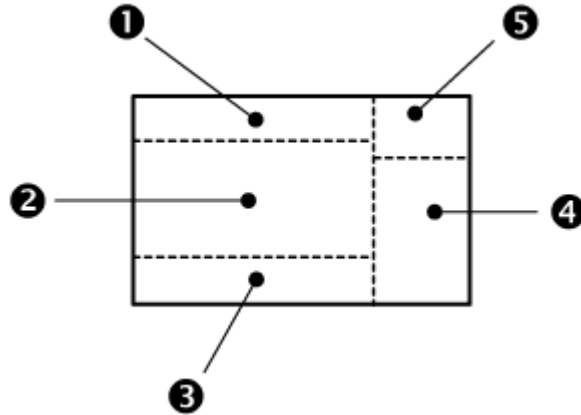

Section	Information shown
①	The selected mode and target, such as INLET 1, OUTLET 1, SENSOR 1, SENSOR 2, and so on.
②	The following information is displayed: <ul style="list-style-type: none"> • Readings, data or state of the selected target. • During the firmware upgrade, "FUP" is displayed.
③	Two types of information may be displayed: <ul style="list-style-type: none"> • The "ALARM" status of the selected target. • The selected inlet line number if your PX3 is a 3-phase model.
④	The measurement unit of the displayed data, such as % or °C.
⑤	This section indicates: <ul style="list-style-type: none"> • The Asset Strip mode if an asset strip has been connected to the PX3. • The device's USB-cascading state - <i>MASTER</i> or <i>SLAVE</i>. If it is a standalone device, neither <i>MASTER</i> nor <i>SLAVE</i> is displayed.

Note: During the firmware upgrade, some PX3 models may show bx in the section 1 to indicate the relay or meter board numbered x is being updated.

Control Buttons

There are four control buttons.

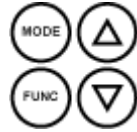

- Up and Down buttons for selecting a specific target, which can be an inlet, outlet, overcurrent protector, environmental sensor or a device setting
- MODE button for switching between various modes, including:
 - Inlet mode
 - Outlet mode
 - Overcurrent Protector mode
 - Device mode
 - Sensor mode
 - Asset Strip mode, indicated by the word ASSET, for showing the asset strip information

See *Overview of the LCD Display* (on page 603) for details.

- FUNC (Function) button for switching between different data of the selected target, such as the current, voltage or power readings of a particular outlet

Operating the LCD Display

After powering on or resetting this product, the LCD display panel shows the current reading of OUTLET 1 by default before you select a different target.

Outlet Information

The Outlet mode is displayed as "OUTLET" on the LCD display. By default the PX3 displays the current reading of OUTLET 1.

Below illustrates the outlet information shown on the LCD display.



Section	Example information
①	The selected target is OUTLET 3.
②	This outlet's current reading is 2 amps.
③	The word "MASTER" indicates the PX3 is the master device in a cascading configuration. For a slave device, it shows "SLAVE" instead. <hr/> <i>Note: As of release 3.3.10, the "MASTER/SLAVE" information is no longer available in the bridging mode, but remains available in the port forwarding mode.</i> <hr/>
④	The measurement unit is A (Amp), indicating that the reading is the RMS current.

► **To display a single-phase outlet's information:**

1. By default this product enters the Outlet mode. If not, press the MODE button until the word "OUTLET" is displayed.
2. In the Outlet mode, press the Up or Down button until the desired outlet's number is displayed at the top of the LCD display.
3. Press the FUNC button to switch between voltage, active power and current readings of the selected target.
 - A is displayed for the current reading. A means Amp.
 - V is displayed for the voltage reading. V means Volt.
 - W is displayed for the power reading. W means Watt.

If the word "ALARM" appears below the reading, it means the currently displayed reading already reaches or crosses the upper or lower thresholds.

► **To display a 3-phase outlet's information**

1. In the Outlet mode, press the Up or Down button until the desired 3-phase outlet is selected.
2. While that 3-phase outlet is being selected, press the Up or Down button to switch between each line, indicated as L1, L2 or L3 at the bottom of the display.
3. When the desired line is being displayed, press the FUNC button to switch between voltage, active power and current readings of this particular line.
 - A is displayed for the current reading. A means Amp.
 - V is displayed for the voltage reading. V means Volt. When voltage is selected, L1-L2, L2-L3, or L3-L1 is displayed at the bottom of the display.

- W is displayed for the power reading. W means Watt.
4. To show the unbalanced load and active power of this 3-phase outlet, do the following:
 - a. Switch to the current reading of L1.
 - b. Press the Down button until '%' or 'W' is displayed to the right of the display. Make sure NONE of the lines (L1, L2, L3, L1-L2, L2-L3 or L3-L1) is displayed at the bottom of the display.
 - Unbalanced load - % is displayed for the unbalanced current value.
 - Active power - W is displayed for the power reading. W means Watt.

Inlet Information

The Inlet mode is displayed as "INLET" on the LCD display. Below illustrates the inlet information shown on the LCD display.



Section	Example information
①	The selected target is INLET 1.
②	This inlet's L1 current reading is 23 amps.
③	The selected inlet line is L1.
④	The word "MASTER" indicates the PX3 is the master device in a cascading configuration. For a slave device, it shows "SLAVE" instead. <i>Note: As of release 3.3.10, the "MASTER/SLAVE" information is no longer available in the bridging mode, but remains available in the port forwarding mode.</i>
⑤	The measurement unit is A (ampere).

► **To display an inlet's information:**

1. Press the MODE button until the term "INLET" is displayed.

2. On a multi-inlet model, press the Up or Down button until the desired inlet's number is displayed at the top.
3. If your PX3 is a 3-phase model, the selected inlet line is indicated below the reading. Press the Up or Down button until the desired inlet line's number (L1, L2, L3, L1-L2, L2-L3 or L3-L1) is shown.
4. Press the FUNC button to switch between voltage, active power and current readings of the selected target.
 - A is displayed for the current reading. A means Amp.
 - V is displayed for the voltage reading. V means Volt.
 - W is displayed for the power reading. W means Watt.

If the word "ALARM" appears below the reading, it means the currently displayed reading already reaches or crosses the upper or lower thresholds.

► **To display the unbalanced load and active power of a 3-phase inlet:**

1. Switch to the current reading of any inlet line.
2. Press the Up or Down button until "W" or "%" is displayed to the right of the LCD display. Make sure NONE of the inlet's line number is displayed at the bottom of the display.
 - Unbalanced load - % is displayed for the unbalanced current value.
 - Active power - W is displayed for the power reading. W means Watt.

Overcurrent Protector Information

The Overcurrent Protector mode is displayed as either "CB" or "FUSE" on the LCD display, which varies according to the type of overcurrent protector implemented on your PX3. CB refers to the circuit breaker and FUSE refers to the fuse.

Below illustrates an overcurrent protector's information.



Section	Example information
①	The selected target is the second circuit breaker (CB 2).
②	This circuit breaker's current reading is 0 amps.
③	The word "CLOSE" indicates that the state of the selected circuit breaker is closed.
④	<p>The word "MASTER" indicates the PX3 is the master device in a cascading configuration. For a slave device, it shows "SLAVE" instead.</p> <hr/> <p><i>Note: As of release 3.3.10, the "MASTER/SLAVE" information is no longer available in the bridging mode, but remains available in the port forwarding mode.</i></p> <hr/>
⑤	The measurement unit is A (Amp), indicating that the reading is the current.

► **To display the overcurrent protector information:**

1. Press the MODE button until the word "CB" or "FUSE" is displayed.
2. In the Overcurrent Protector mode, press the Up or Down button until the desired overcurrent protector's number is displayed at the top of the LCD display.
3. Check the reading and the text shown below the reading: CLOSE or OPEN.
 - CLOSE: The selected circuit breaker is closed, or the selected fuse is normal.
 - OPEN: The selected circuit breaker is open, or the selected fuse has burned out. When this occurs, the term CbE is displayed in place of the reading and a blinking word "ALARM" appears next to the word OPEN.

IPv4 Address

The IP address is available in the Device mode, which is indicated by the alphabet 'd' shown at the top of the LCD display. Note that the LCD display only shows the IPv4 address (if available).

Below illustrates the IP address information.

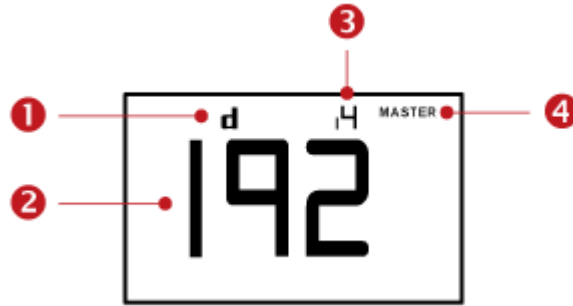

Section	Example information
①	"d" means the LCD display has entered the Device mode.
②	The LCD display is showing 192, which is one of the four IP address octets. It will cycle through four octets.
③	"i4" indicates that the IP address shown on the LCD display is an IPv4 address.
④	The word "MASTER" indicates the PX3 is the master device in a cascading configuration. For a slave device, it shows "SLAVE" instead. <i>Note: As of release 3.3.10, the "MASTER/SLAVE" information is no longer available in the bridging mode, but remains available in the port forwarding mode.</i>

If you connect your PX3 to the wireless network, a Wi-Fi icon is displayed at the bottom-right corner.

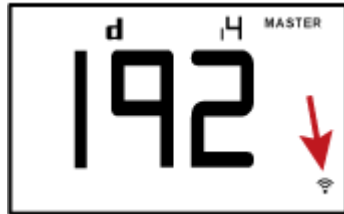

► **To display the IPv4 address:**

1. Press the MODE button to enter the Device mode, indicated by an alphabet "d" at the top left of the display.
2. The LCD display cycles between the four octets of the IPv4 address, indicated by "i4" at the upper right corner of the display.

For example, 192.168.84.4 cycles in this sequence:

192 --> 168 --> 84 --> 4

MAC Address

This product's MAC address is retrievable by operating the LCD display. Below illustrates the MAC address information.



Section	Example information
①	"d" means the LCD display has entered the Device mode.
②	"M" indicates that the displayed information is the MAC address.
③	<p>The word "MASTER" indicates the PX3 is the master device in a cascading configuration. For a slave device, it shows "SLAVE" instead.</p> <hr/> <p><i>Note: As of release 3.3.10, the "MASTER/SLAVE" information is no longer available in the bridging mode, but remains available in the port forwarding mode.</i></p>
④	The LCD display is showing "03," which is part of the MAC address.

► **To display the MAC address:**

1. Press the MODE button to enter the Device mode, indicated by a 'd' in at the top left of the display.
2. Press the FUNC button until the MAC address is displayed. The character "M" appears in the left side of the LCD display.

- The MAC address is displayed as "M:XX", where XX are two digits of the MAC address. The LCD will cycle through the MAC address from the first two digits to the final two.

For example, if the MAC address is 00:0d:5d:03:5E:1A, the LCD display shows the following information one after another:

M 00 --> M:0d --> M:5d --> M:03 --> M:5E --> M:1A

Note that 'M' is NOT followed by the colon symbol when showing the first two digits of the MAC address.

Outlet Switching

This section applies to outlet-switching capable models only.

You can turn on or off any outlet using the LCD display in the outlet switching mode. To do this, you must first enable the front panel outlet control function. See **Miscellaneous** (on page 332).

► **To turn on or off an outlet:**

- Press the MODE button until the LCD display enters the outlet switching mode, which is indicated by the power state of OUTLET 1.
 - When outlet 1 has been powered on, the word 'on' is displayed as shown below.



- When outlet 1 has been powered off, the word "oFF" is displayed instead.
- Press the Up or Down button to select the desired outlet. The selected outlet's number is displayed at the top of the LCD display.
 - Press the FUNC button to perform the outlet switching operation. The LCD display cycles between two messages as shown in the two diagrams below. In the following diagrams, X represents the selected outlet's number.

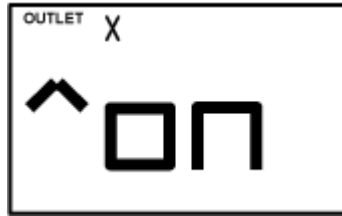

To cancel the outlet switching operation, press the FUNC button again.

4. To turn on the outlet, press the Up button. The "on?" confirmation message displays.

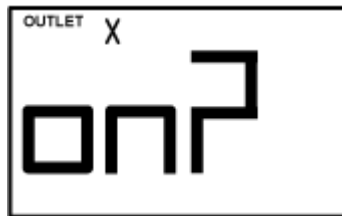

To turn off the outlet, press the Down button. The "oF?" confirmation message displays.



5. Press the same button as step 4 again to confirm the operation.

Note: If you press a different button in this step, for example, pressed the Down button in step 4 but the Up button in step 5, the outlet switching operation is not confirmed and the LCD display will return to the messages in step 3.

6. The outlet switching operation is confirmed now and the LCD display indicates the latest power state of the selected outlet.
 - on: The outlet has been turned on.
 - oFF: The outlet has been turned off.
7. You can verify the power state of the selected outlet by checking its LED color. Green indicates the power off state and red indicates the power on state.

Environmental Sensor Information

The environmental sensor mode is displayed as "SENSOR" on the LCD display. Basic information about a specific environmental sensor is available, including the sensor's reading or state, X, Y, Z coordinates and its serial number.

Below illustrates the environmental sensor information.

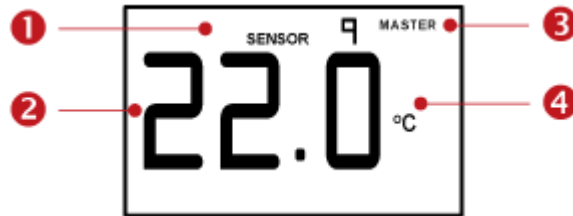

Number	Example information
①	The selected target is the environmental sensor whose ID number is 9 (SENSOR 9).
②	The selected environmental sensor's reading is 22 °C.
③	The word "MASTER" indicates the PX3 is the master device in a cascading configuration. For a slave device, it shows "SLAVE" instead. <hr/> <i>Note: As of release 3.3.10, the "MASTER/SLAVE" information is no longer available in the bridging mode, but remains available in the port forwarding mode.</i>
④	The measurement unit is °C (degrees in Celsius).

► **To display the environmental sensor information:**

1. Press the MODE button until this product enters the Sensor mode, as indicated by "SENSOR" at the top of the LCD display.
2. Press the Up or Down button until the desired environmental sensor's ID number is displayed.
3. For example, "SENSOR 1" refers to the sensor #1 listed on the PX3 web interface.
4. The LCD display shows the reading or state of the selected sensor in the middle of the LCD display.
 - When showing a numeric sensor's reading, the appropriate measurement unit is displayed to the right of the reading.

Measurement units	Sensor types
%	A relative humidity sensor
°C	A temperature sensor
m/s	An air flow sensor
Pa	An air pressure sensor
NO measurement units	For an "absolute" humidity sensor, the measurement unit is g/m ³ , which cannot be displayed on the LCD.

- Available states for a state sensor:

States	Description
nor	Normal state.
ALA	Alarmed state. <ul style="list-style-type: none"> This state is accompanied with the word "ALARM" below it.

- Available states for a dry contact signal actuator (DX sensor series):

States	Description
On	The actuator is turned on.
Off	The actuator is turned off.

Note: Numeric sensors show both numeric readings and sensor states to indicate environmental or internal conditions while state sensors show sensor states only to indicate state changes.

- Press the FUNC button to show the sensor's port position. There are two types of information.
 - $P:n$ (where n is the SENSOR port's number): This information indicates the SENSOR port number.
 - $C:x$ (where x is the sensor's position in a sensor chain): This information indicates the sensor's position in a chain, which is available for DPX2, DPX3 and DX sensors only. The LCD display will cycle between the port information ($P:n$) and chain position information ($C:x$).

Note that if the DPX3-ENVHUB4 sensor hub is used to connect the DPX2, DPX3 or DX sensors, the chain position information (C:x) is displayed twice - the first one indicates the sensor hub's chain position, which is always *C:1*, and the second one indicates the sensor's chain position.

6. Press the FUNC button to display the X, Y and Z coordinates of the sensor respectively.
 - X coordinate is shown as "x:NN," where NN are the first two numeric digits entered for the X coordinate in the web interface.
 - Y coordinate is shown as "y:NN," where NN are the first two numeric digits entered for the Y coordinate in the web interface.
 - Z coordinate is shown as "z:NN," where NN are the first two numeric digits entered for the Z coordinate in the web interface.

If one or both of the first two digits for a specific coordinate are alphabetical characters, these alphabetical characters are replaced with dashes (-).

7. Press the FUNC button to display the serial number of the sensor, which is shown as "s:XX," where XX are two digits of the serial number. The LCD will cycle through the serial number from the first two digits to the final two.

For example, if the serial number is AE17A00022, the LCD display shows the following information one after another:

s:AE --> s:17 --> s:A0 --> s:00 --> s:22

Note: Some alphabets cannot be properly displayed due to the LCD display restriction. For example, Q looks like 9, Z looks like 2, and M looks like Ξ . Check the sensor's label or the web interface when you have doubts.

Asset Strip Information

If there is any asset strip connected to the PX3, you can enter the Asset Strip mode to show the asset tag state of each rack unit on the asset strip. A rack unit refers to a tag port on the asset strips.

When there are no asset strips connected, this mode is not available.

Below illustrates the asset strip information.



Section	Example information
①	"1" refers to the asset strip connected to the first FEATURE port.
②	This symbol  indicates that you can switch between diverse rack units now by pressing the Up or Down button.
③	"30" indicates that the selected target is the 30th rack unit.
④	The word "MASTER" indicates the PX3 is the master device in a cascading configuration. For a slave device, it shows "SLAVE" instead. <hr/> <i>Note: As of release 3.3.10, the "MASTER/SLAVE" information is no longer available in the bridging mode, but remains available in the port forwarding mode.</i> <hr/>
⑤	"ASSET" means that the LCD display enters the Asset Strip mode.

► **To display the asset management information:**

1. Press the MODE button until the PX3 enters the Asset Strip mode, as indicated by "ASSET" to the right of the LCD.
2. By default the PX3 selects the asset strip connected to the first FEATURE port so it shows "1" at the top. Because the PX3 has only one FEATURE port, "1" is the only option.
3. Press the FUNC button. When a blinking double-arrow symbol  appears to the left of the LCD display, press the Up or Down button to select the desired rack unit on the asset strip. The rack unit number appears in the middle of the LCD display.

Note: Press and hold the Up or Down button for at least two (2) seconds to quickly move through several items at once.

- If the word "ALARM" appears below the rack unit number, it means no asset tag is physically connected to that rack unit.
- If the word "ALARM" does NOT appear, it means a connected asset tag is detected on the rack unit.

USB-Cascaded Device's Position

Note: As of release 3.3.10, the following cascading information is no longer available in the bridging mode, but remains available in the port forwarding mode.

A cascaded device's position is available by operating the LCD display. Below illustrates a slave device's position.

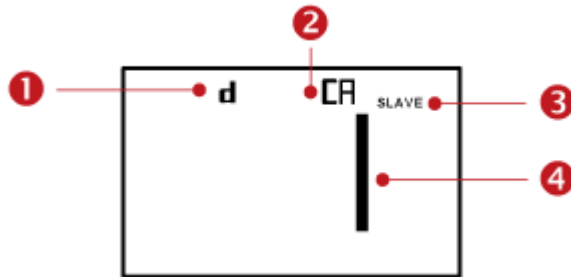

Section	Example information
①	"d" means the LCD display has entered the Device mode.
②	"CA" indicates that the cascading information is being displayed.
③	"SLAVE" indicates that this PX3 is a slave device. <i>Note: For a master device, it shows the word "MASTER" instead.</i>
④	The number 1 means the device position is Slave 1.

► **To retrieve the device's USB-cascading position information:**

1. Press the MODE button to enter the Device mode, indicated by a 'd' in at the top left of the display.
2. Press the FUNC button until "CA" is displayed at the top right of the display.
3. The device's position is represented by any number defined below:

Number	Device position
0	Master device
1	Slave 1
2	Slave 2

Number	Device position
3	Slave 3
4	Slave 4
5	Slave 5
6	Slave 6
7	Slave 7

As of release 3.3.10, the port forwarding mode supports up to 15 slave devices so the numbers 8 to 15 may be shown in this mode.

RCM Information

If your "old" PX3 model supports residual current monitoring (RCM), this information is available in the front panel LCD display. For more information on RCM, see *PX3 Models with Residual Current Monitoring* (on page 588).

The front panel LCD display shows an alarm message when the RCM enters the critical state. Besides, you can operate the LCD display to check the RCM status.

*Note: For the RCM information shown on the dot-matrix LCD display, see **Front Panel Operations for RCM** (on page 594).*

► RCM alarm information in the critical state:

In the RCM critical state, the PDU beeps and the LCD display indicates the RCM critical state.

The RCM alarm information continues to display as long as RCM is in a critical state. The following RCM alarm messages are displayed one by one in the critical state.

rCA --> rCA --> Residual current value (mA)

The diagram below illustrates the RCM alarm on the LCD display.

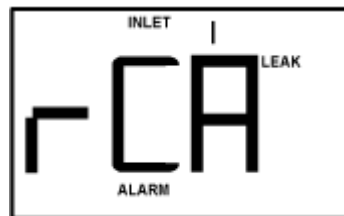

► To display the RCM current:

1. Press the MODE button until the term "INLET" is displayed.

2. Verify the LCD is showing the inlet's current, which is indicated by the presence of the letter "A." If not, switch to current by pressing the FUNC button.
3. Depending on the type of your PX3, the procedure to display the residual current slightly differs.
 - Single-phase PDU: Press the Up or Down button until the word "LEAK" displays.
 - 3-phase PDU: Press the Up button until the word "LEAK" displays.

Below illustrates the residual current information shown on the LCD display.

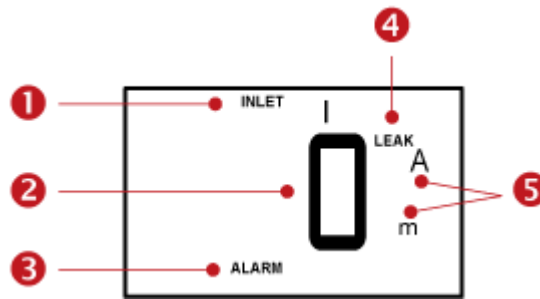

Section	Example information
①	The inlet containing RCM sensor is INLET 1.
②	This residual current is 0 mA.
③	<i>ALARM</i> always displays for residual current sensor.
④	<i>LEAK</i> always displays for residual current sensor.
⑤	Measurement units are mA.

► **To run RCM self-test:**

1. Press the MODE button until the LCD alternates between "SLF" and "tSt," which means **SELF TEST**.
2. Press the FUNC button to start RCM self-test.
3. The LCD shows dash symbols during RCM self-test.
4. Upon completion, RCM self-test results are displayed for 30 seconds, or until you press any button.
 - PAS: Self-test passed.
 - FAL: Self-test failed (the PX3 also beeps).

Below illustrates the RCM self-test mode.



Section	Example information
①	The inlet containing RCM sensor is INLET 1.
②	The LCD alternates between "SLF" and "tSt" to indicate that this is self-test mode.
③	<i>ALARM</i> always displays for residual current sensor.
④	<i>LEAK</i> always displays for residual current sensor.

*Note: To disable or enable this front panel function, see **Disabling or Enabling Front Panel RCM Self-Test** (on page 593). By default, this function is enabled.*

Appendix H LDAP Configuration Illustration

This section provides an LDAP example for illustrating the configuration procedure using Microsoft Active Directory® (AD). To configure LDAP authentication, four main steps are required:

- a. Determine user accounts and roles (groups) intended for the PX3
- b. Create user groups for the PX3 on the AD server
- c. Configure LDAP authentication on the PX3 device
- d. Configure roles on the PX3 device

Important: Raritan disables SSL 3.0 and uses TLS for releases 3.0.4, 3.0.20 and later releases due to published security vulnerabilities in SSL 3.0. Make sure your network infrastructure, such as LDAP and mail services, uses TLS rather than SSL 3.0.

In This Chapter

Step A. Determine User Accounts and Roles	621
Step B. Configure User Groups on the AD Server	622
Step C. Configure LDAP Authentication on the PX3 Device	623
Step D. Configure Roles on the PX3 Device	624

Step A. Determine User Accounts and Roles

Determine the user accounts and roles (groups) that are authenticated for accessing the PX3. In this example, we will create two user roles with different permissions. Each role (group) will consist of two user accounts available on the AD server.

User roles	User accounts (members)
PX_User	usera
	pxuser2
PX_Admin	userb
	pxuser

Group permissions:

- The PX_User role will have neither system permissions nor outlet permissions.
- The PX_Admin role will have full system and outlet permissions.

Step B. Configure User Groups on the AD Server

You must create the groups (roles) for the PX3 on the AD server, and then make appropriate users members of these groups.

In this illustration, we assume:

- The groups (roles) for the PX3 are named *PX_Admin* and *PX_User*.
- User accounts *pxuser*, *pxuser2*, *usera* and *userb* already exist on the AD server.

► To configure user groups on the AD server:

1. On the AD server, create new groups -- *PX_Admin* and *PX_User*.

Note: See the documentation or online help accompanying Microsoft AD for detailed instructions.

2. Add the *pxuser2* and *usera* accounts to the *PX_User* group.
3. Add the *pxuser* and *userb* accounts to the *PX_Admin* group.
4. Verify whether each group comprises correct users.

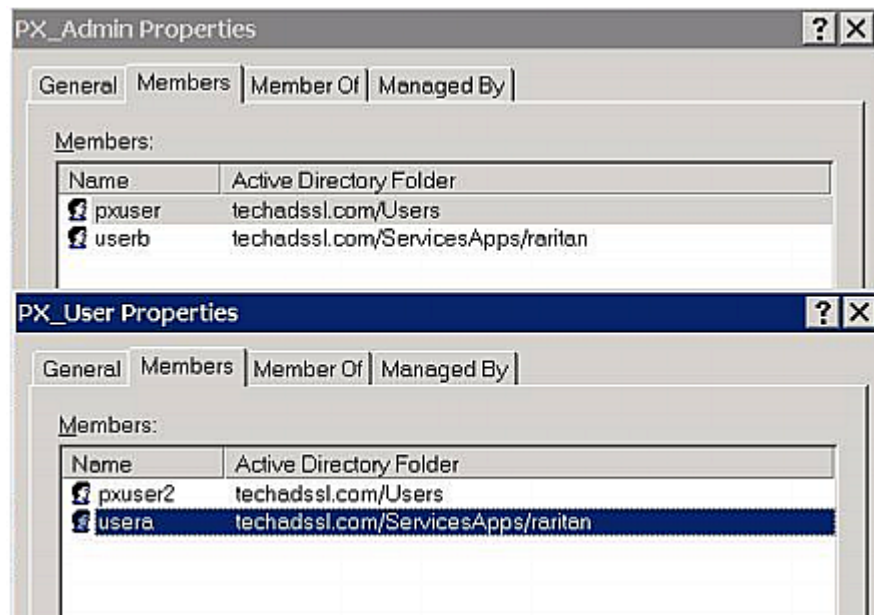

Step C. Configure LDAP Authentication on the PX3 Device

You must enable and set up LDAP authentication properly on the PX3 device to use external authentication.

In the illustration, we assume:

- The DNS server settings have been configured properly. See *Wired Network Settings* (on page 219) and *Role of a DNS Server* (on page 688).
- The AD server's domain name is *techadssl.com*, and its IP address is *192.168.56.3*.
- The AD protocol is NOT encrypted over TLS.
- The AD server uses the default TCP port *389*.
- Anonymous bind is used.

► **To configure LDAP authentication:**

1. Choose Device Settings > Security > Authentication.
2. In the LDAP Servers section, click New to add an LDAP/LDAPS server.
3. Provide the PX3 with the information about the AD server.

Field/setting	Do this...
IP Address / Hostname	Type the domain name <code>techadssl.com</code> or IP address <code>192.168.56.3</code> . <i>Important: Without the encryption enabled, you can type either the domain name or IP address in this field, but you must type the fully qualified domain name if the encryption is enabled.</i>
Copy settings from existing LDAP server	Leave the checkbox deselected unless the new LDAP server's settings are similar to any existing LDAP settings.
Type of LDAP Server	Select "Microsoft Active Directory."
Security	Select "None" since the TLS encryption is not applied in this example.
Port (None/StartTLS)	Ensure the field is set to 389.
Port (TLS), CA Certificate	Skip the two fields since the TLS encryption is not enabled.
Anonymous Bind	Select this checkbox because anonymous bind is used.

Field/setting	Do this...
Bind DN, Bind Password, Confirm Bind Password	Skip the three fields because of anonymous bind.
Base DN for Search	Type <code>dc=techadssl,dc=com</code> as the starting point where your search begins on the AD server.
Login Name Attribute	Ensure the field is set to <code>sAMAccountName</code> because the LDAP server is Microsoft Active Directory.
User Entry Object Class	Ensure the field is set to <code>user</code> because the LDAP server is Microsoft Active Directory.
User Search Subfilter	The field is optional. The subfilter information is also useful for filtering out additional objects in a large directory structure. In this example, we leave it blank.
Active Directory Domain	Type <code>techadssl.com</code> .

4. Click Add Server. The LDAP server is saved.
5. In the Authentication Type field, select LDAP.
6. Click Save. The LDAP authentication is activated.

Note: If the PX3 clock and the LDAP server clock are out of sync, the installed TLS certificates, if any, may be considered expired. To ensure proper synchronization, administrators should configure the PX3 and the LDAP server to use the same NTP server(s).

Step D. Configure Roles on the PX3 Device

A role on the PX3 device determines the system and outlet permissions. You must create the roles whose names are identical to the user groups created for the PX3 on the AD server or authorization will fail. Therefore, we will create the roles named *PX_User* and *PX_Admin* on the PDU.

In this illustration, we assume:

- Users assigned to the *PX_User* role can view settings only, but they can neither configure PX3 nor access the outlets.
- Users assigned to the *PX_Admin* role have the Administrator Privileges so they can both configure PX3 and access the outlets.

► **To create the *PX_User* role with appropriate permissions assigned:**

1. Choose User Management > Roles.

2. Click  to add a new role.
 - a. Type `PX_User` in the Role Name field.
 - b. Type a description for the `PX_User` role in the Description field. In this example, we type "View PX settings" to describe the role.
 - c. In the Privileges list, select Unrestricted View Privileges, which includes all View permissions. The Unrestricted View Privileges permission lets users view all settings without the capability to configure or change them.

<input checked="" type="checkbox"/>	Unrestricted View Privileges
<input type="checkbox"/>	View Event Settings
<input type="checkbox"/>	View Local Event Log
<input type="checkbox"/>	View Local User Management
<input type="checkbox"/>	View Security Settings
<input type="checkbox"/>	View SNMP Settings
<input type="checkbox"/>	View Webcam Snapshots and Configuration

- d. Click Save.
3. The `PX_User` role is created.

Role Name ▲	Description
Admin	System defined administrator role including all privileges. 
Operator	Predefined operator role.
PX_User	View PX settings

4. Keep the Roles page open to create the `PX_Admin` role.

► **To create the PX_Admin role with full permissions assigned:**

1. Click  to add another role.
 - a. Type PX_Admin in the Role Name field.
 - b. Type a description for the PX_Admin role in the Description field. In this example, we type "Includes all PX privileges" to describe the role.
 - c. In the Privileges list, select Administrator Privileges. The Administrator Privileges allows users to configure or change all PX3 settings.

Privileges ▲

Select privilege to add to role. Be aware some privileges may require additional arguments.

- Acknowledge Alarms
- Administrator Privileges
- Change Asset Strip Configuration
- Change Authentication Settings

- d. Click Save.
2. The PX_Admin role is created.

Role Name ▲	Description
Admin	System defined administrator role including all privileges. 
Operator	Predefined operator role.
PX_Admin	Includes all PX privileges
PX_User	View PX settings

Appendix I Updating the LDAP Schema

In This Chapter

Returning User Group Information	627
Setting the Registry to Permit Write Operations to the Schema	628
Creating a New Attribute.....	628
Adding Attributes to the Class	629
Updating the Schema Cache	631
Editing rciusergroup Attributes for User Members	631

Returning User Group Information

Use the information in this section to return User Group information (and assist with authorization) once authentication is successful.

From LDAP/LDAPS

When an LDAP/LDAPS authentication is successful, the PX3 determines the permissions for a given user based on the permissions of the user's role. Your remote LDAP server can provide these user role names by returning an attribute named as follows:

rciusergroup attribute type: string

This may require a schema extension on your LDAP/LDAPS server. Consult your authentication server administrator to enable this attribute.

In addition, for Microsoft® Active Directory®, the standard LDAP memberOf is used.

From Microsoft Active Directory

Note: This should be attempted only by an experienced Active Directory® administrator.

Returning user role information from Microsoft's® Active Directory for Windows 2000® operating system server requires updating the LDAP/LDAPS schema. See your Microsoft documentation for details.

1. Install the schema plug-in for Active Directory. See Microsoft Active Directory documentation for instructions.
2. Run Active Directory Console and select Active Directory Schema.

Setting the Registry to Permit Write Operations to the Schema

To allow a domain controller to write to the schema, you must set a registry entry that permits schema updates.

► **To permit write operations to the schema:**

1. Right-click the Active Directory® Schema root node in the left pane of the window and then click Operations Master. The Change Schema Master dialog appears.

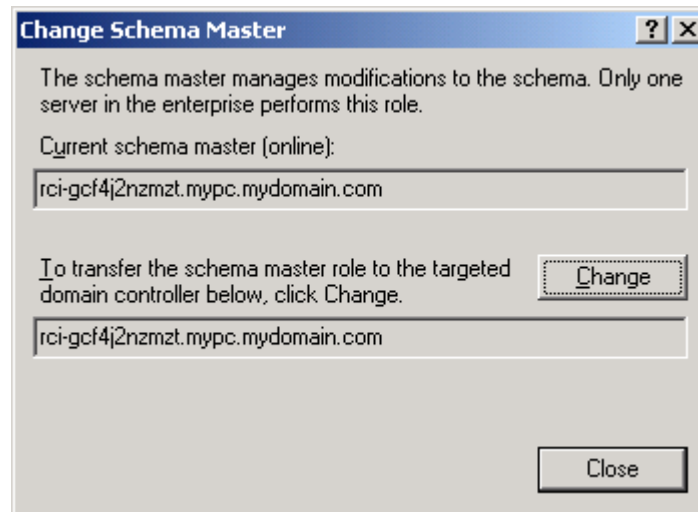

2. Select the "Schema can be modified on this Domain Controller" checkbox. **Optional**
3. Click OK.

Creating a New Attribute

► **To create new attributes for the rcigroup class:**

1. Click the + symbol before Active Directory® Schema in the left pane of the window.
2. Right-click Attributes in the left pane.

3. Click New and then choose Attribute. When the warning message appears, click Continue and the Create New Attribute dialog appears.

Create New Attribute

Create a New Attribute Object

Identification

Common Name: rciusergroup

LDAP Display Name: rciusergroup

Unique X500 Object ID: 1.3.6.1.4.1.13742.50

Description: Raritan's LDAP attribute

Syntax and Range

Syntax: Case Insensitive String

Minimum: 1

Maximum: 24

Multi-Valued

OK Cancel

4. Type *rciusergroup* in the Common Name field.
5. Type *rciusergroup* in the LDAP Display Name field.
6. Type *1.3.6.1.4.1.13742.50* in the Unique x5000 Object ID field.
7. Type a meaningful description in the Description field.
8. Click the Syntax drop-down arrow and choose Case Insensitive String from the list.
9. Type *1* in the Minimum field.
10. Type *24* in the Maximum field.
11. Click OK to create the new attribute.

Adding Attributes to the Class

► **To add attributes to the class:**

1. Click Classes in the left pane of the window.

2. Scroll to the user class in the right pane and right-click it.

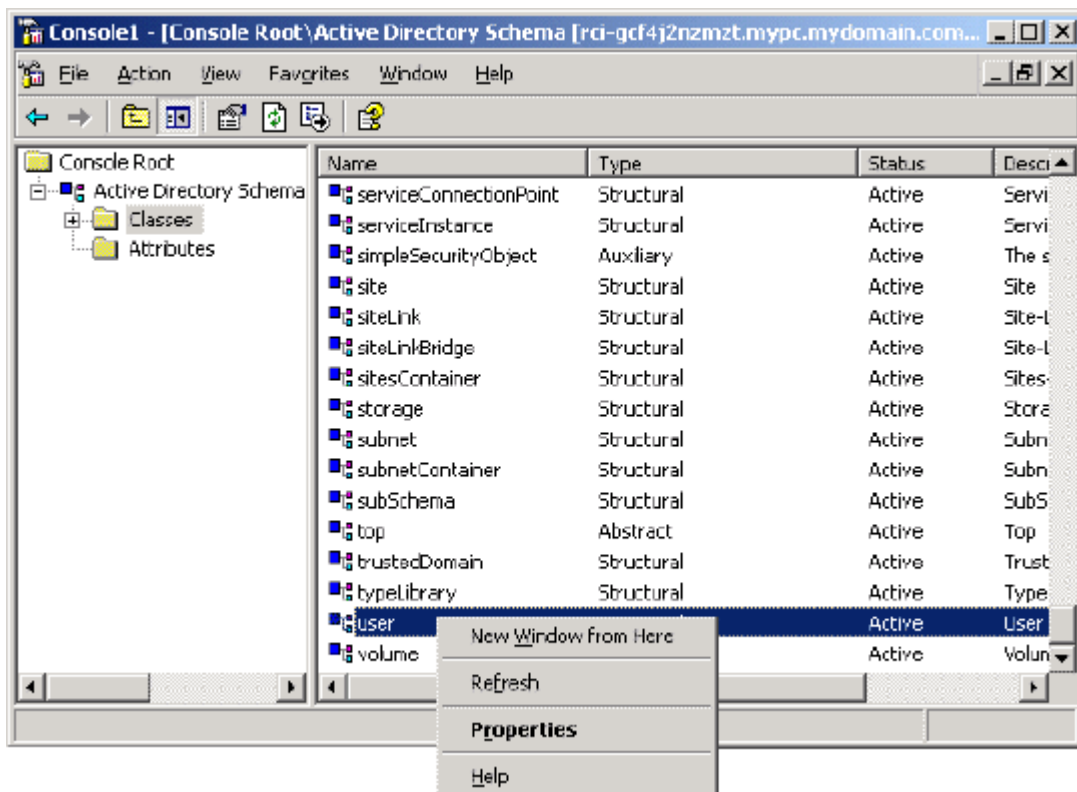

3. Choose Properties from the menu. The user Properties dialog appears.
4. Click the Attributes tab to open it.
5. Click Add.

6. Choose rcusergroup from the Select Schema Object list.

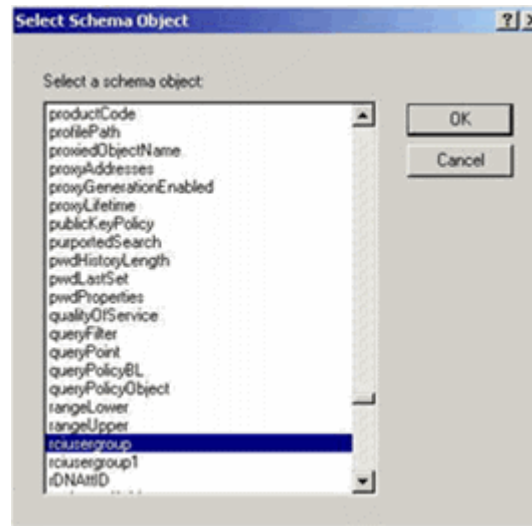

7. Click OK in the Select Schema Object dialog.
8. Click OK in the User Properties dialog.

Updating the Schema Cache

► **To update the schema cache:**

1. Right-click Active Directory® Schema in the left pane of the window and select Reload the Schema.
2. Minimize the Active Directory Schema MMC (Microsoft® Management Console) console.

Editing rcusergroup Attributes for User Members

To run the Active Directory® script on a Windows 2003® server, use the script provided by Microsoft® (available on the Windows 2003 server installation CD). These scripts are loaded onto your system with a Microsoft® Windows 2003 installation. ADSI (Active Directory Service Interface) acts as a low-level editor for Active Directory, allowing you to perform common administrative tasks such as adding, deleting, and moving objects with a directory service.

► **To edit the individual user attributes within the group rcusergroup:**

1. From the installation CD, choose Support > Tools.
2. Double-click SUPTOOLS.MSI to install the support tools.

- Go to the directory where the support tools were installed. Run `adsiedit.msc`. The ADSI Edit window opens.

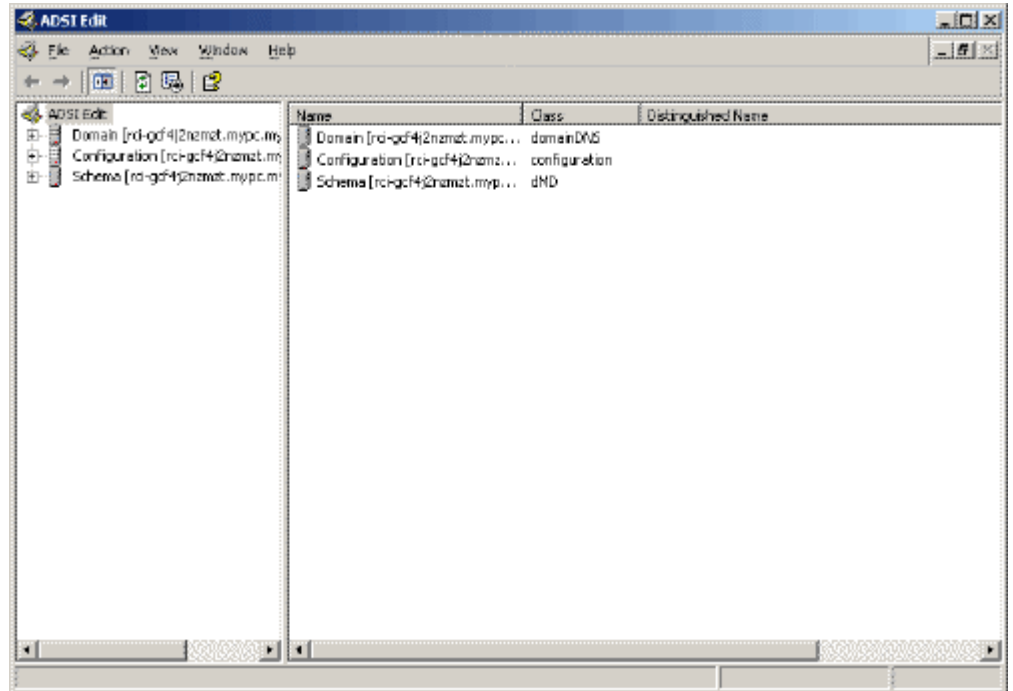

- Open the Domain.
- In the left pane of the window, select the CN=Users folder.

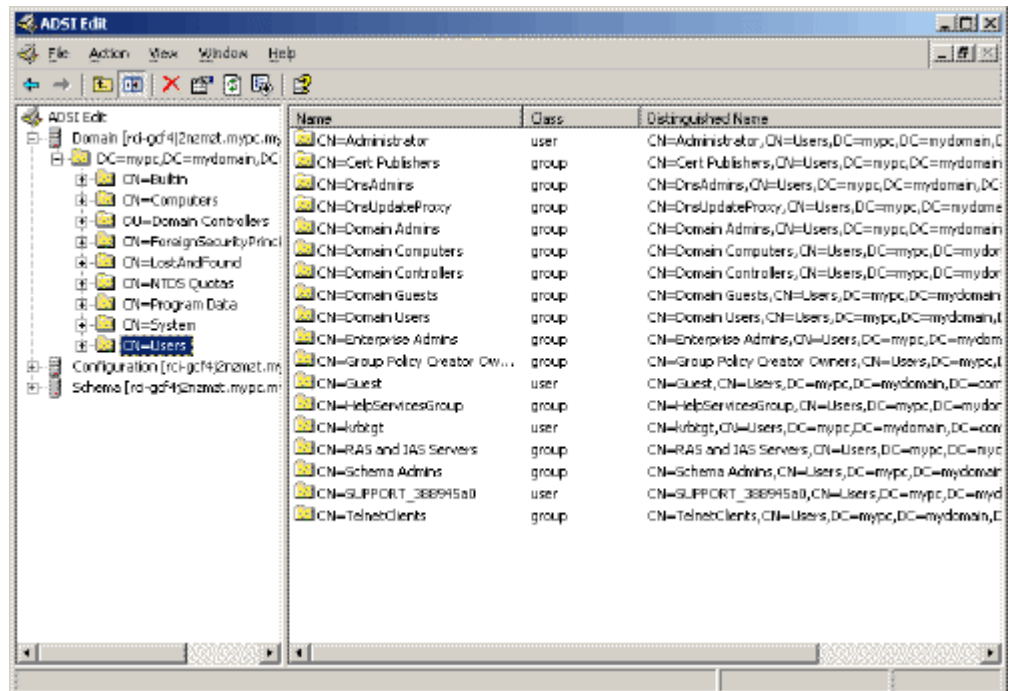

6. Locate the user name whose properties you want to adjust in the right pane. Right-click the user name and select Properties.
7. Click the Attribute Editor tab if it is not already open. Choose rciusergroup from the Attributes list.

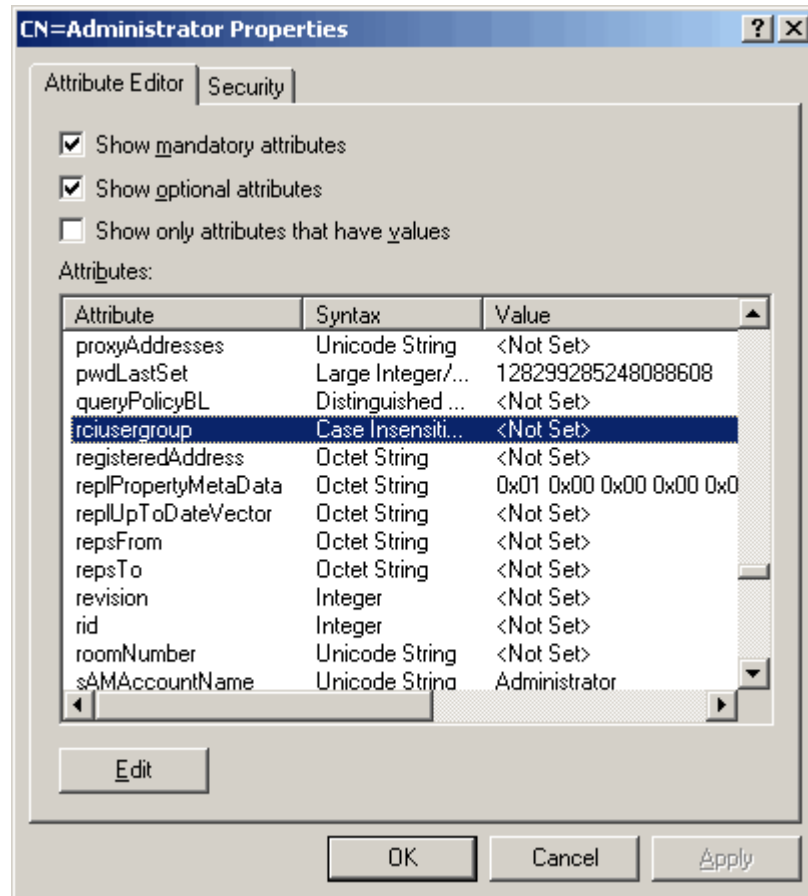

8. Click Edit. The String Attribute Editor dialog appears.
9. Type the user role (created in the PX3) in the Edit Attribute field. Click OK.

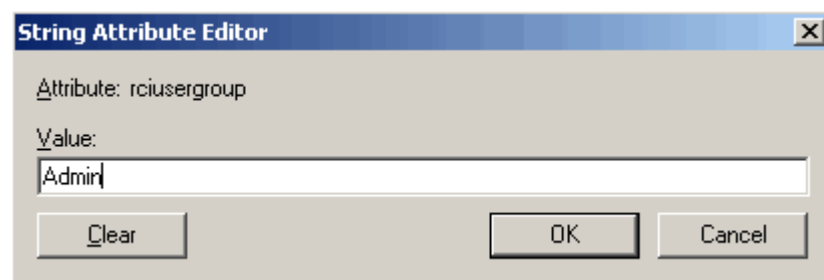

Appendix J RADIUS Configuration Illustration

This section provides illustrations for configuring RADIUS authentication. One illustration is based on the Microsoft® Network Policy Server (NPS), and the other is based on a FreeRADIUS server.

The following steps are required for any RADIUS authentication:

1. Configure RADIUS authentication on the PX3. See *Adding Radius Servers* (on page 263).
2. Configure roles on the PX3. See *Creating Roles* (on page 213).
3. Configure PX3 user credentials and roles on your RADIUS server.
 - To configure using standard attributes, see *Standard Attributes* (on page 634).
 - To configure using vendor-specific attributes, see *Vendor-Specific Attributes* (on page 653).

Note that we assume that the NPS is running on a Windows 2008 system in the NPS illustrations.

In This Chapter

Standard Attributes	634
Vendor-Specific Attributes	653
AD-Related Configuration	666

Standard Attributes

The RADIUS standard attribute "Filter-ID" is used to convey the group membership, that is, roles.

- If a user has multiple roles, configure multiple standard attributes for this user.
- The syntax of a standard attribute is:
`Raritan:G{role-name}`

For configuration on NPS, see *NPS Standard Attribute Illustration* (on page 634).

For configuration on FreeRADIUS, see *FreeRADIUS Standard Attribute Illustration* (on page 652).

NPS Standard Attribute Illustration

To configure Windows 2008 NPS with the *standard attribute*, you must:

- a. Add your PX3 to NPS. See *Step A: Add Your PX3 as a RADIUS Client* (on page 635).

- b. On the NPS, configure Connection Request Policies and the standard attribute. See **Step B: Configure Connection Policies and Standard Attributes** (on page 639).

Some configuration associated with Microsoft Active Directory (AD) is also required for RADIUS authentication. See **AD-Related Configuration** (on page 666).

Step A: Add Your PX3 as a RADIUS Client

The RADIUS implementation on a PX3 follows the standard RADIUS Internet Engineering Task Force (IETF) specification so you must select "RADIUS Standard" as its vendor name when configuring the NPS server.

► Presumptions in the illustration:

- IP address of your PX3 = 192.168.56.29
- RADIUS authentication port specified for PX3: 1812
- RADIUS accounting port specified for PX3: 1813

► To add your PX3 to the RADIUS NPS:

1. Choose Start > Administrative Tools > Network Policy Server. The Network Policy Server console window opens.

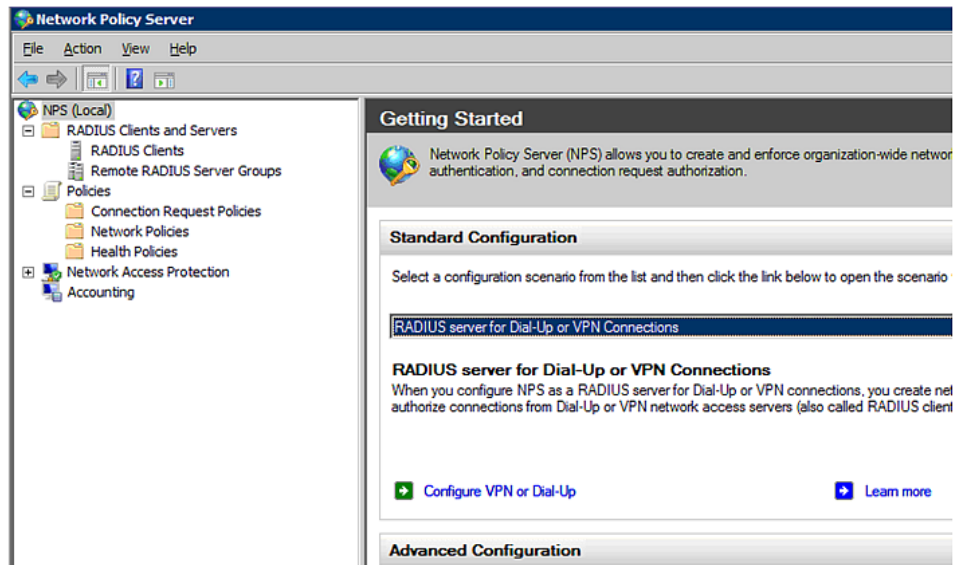

2. Right-click NPS (Local), and select Properties.

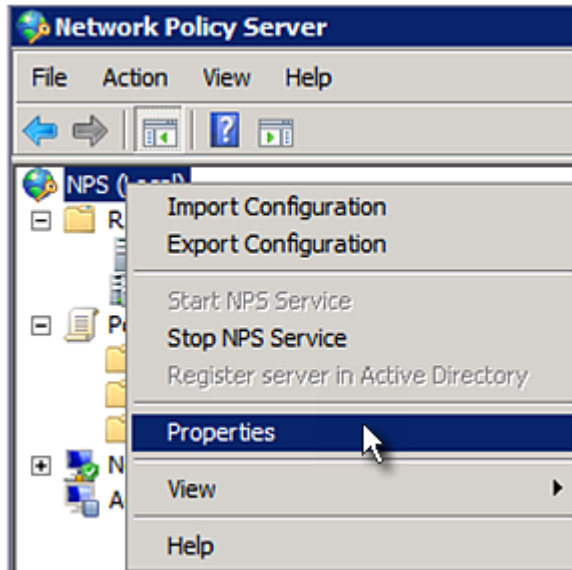

Verify the authentication and accounting port numbers shown in the properties dialog are the same as those specified on your PX3. In this example, they are 1812 and 1813. Then close this dialog.

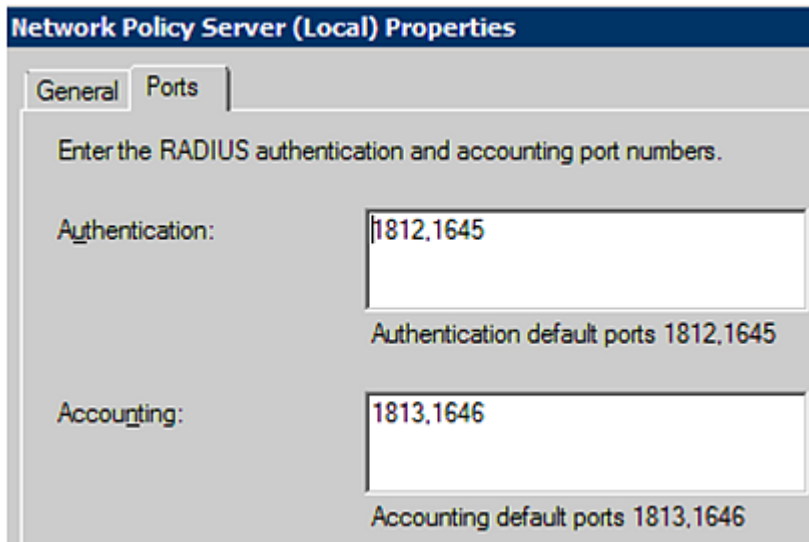

3. Under "RADIUS Clients and Servers," right-click RADIUS Client and select New RADIUS Client. The New RADIUS Client dialog appears.

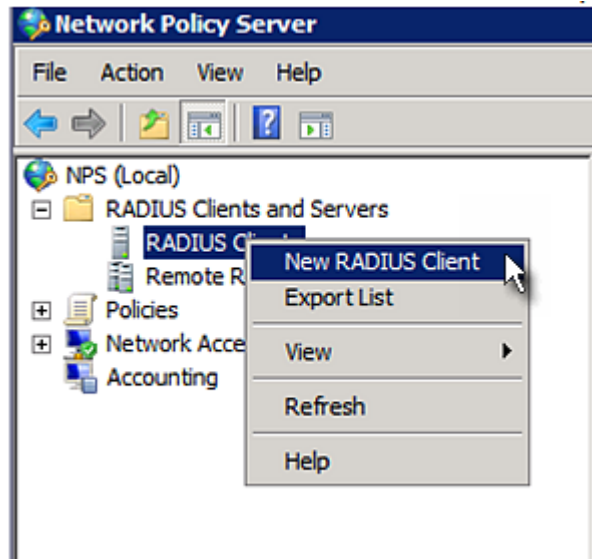

4. Do the following to add your PX3 to NPS:
 - a. Verify the "Enable this RADIUS client" checkbox is selected.
 - b. Type a name for identifying your PX3 in the "Friendly name" field.
 - c. Type *192.168.56.29* in the "Address (IP or DNS)" field.
 - d. Select *RADIUS Standard* in the "Vendor name" field.
 - e. Select the *Manual* radio button.

- f. Type the shared secret in the "Shared secret" and "Confirm shared secret" fields. The shared secret must be the same as the one specified on your PX3.

- 5. Click OK.

Step B: Configure Connection Policies and Standard Attributes

You need to configure the following for connection request policies:

- IP address or host name of the PX3
 - Connection request forwarding method
 - Authentication method(s)
 - Standard RADIUS attributes
- **Presumptions in the illustration:**
- IP address of your PX3 = 192.168.56.29
 - *Local* NPS server is used
 - RADIUS protocol selected on your PX3 = CHAP
 - Existing role of your PX3 = Admin

► **Illustration:**

1. Open the NPS console, and expand the Policies folder.

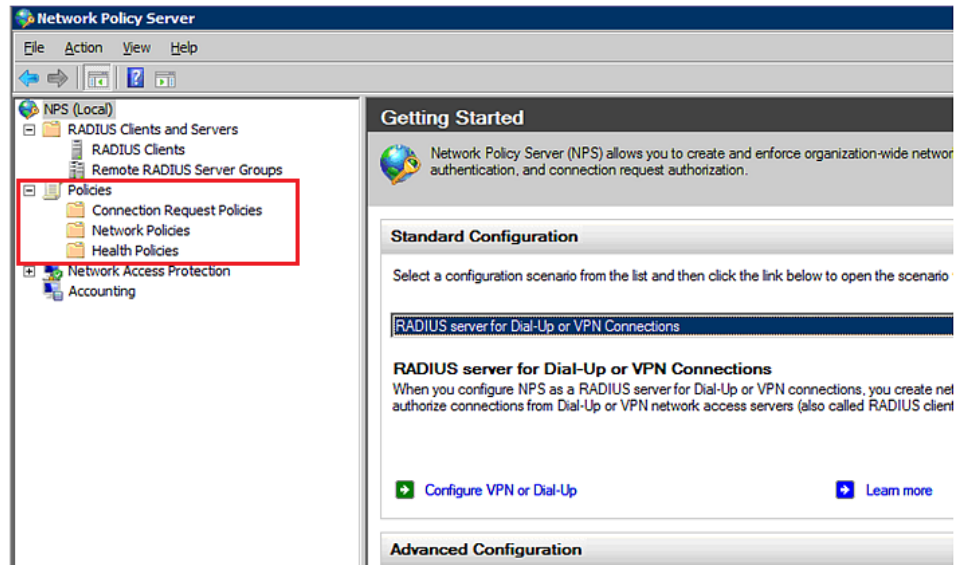

2. Right-click Connection Request Policies and select New. The New Connection Request Policy dialog appears.

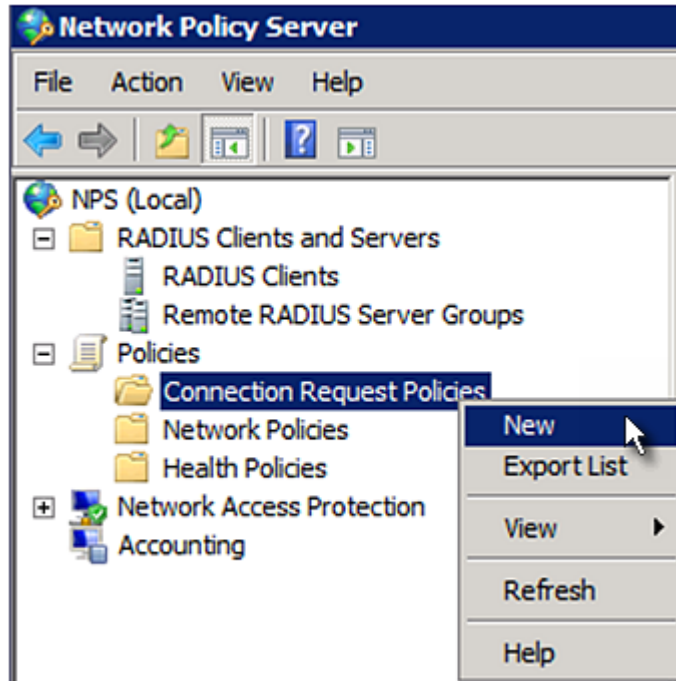

3. Type a descriptive name for identifying this policy in the "Policy name" field.

- You can leave the "Type of network access server" field to the default -- Unspecified.

New Connection Request Policy



Specify Connection Request Policy Name

You can specify a name for your connection request policy and it will be applied.

Policy name:

Network connection method
Select the type of network access server that sends the connection request to NPS.
type or Vendor specific.

Type of network access server:

Vendor specific:

- Click Next to show the "Specify Conditions" screen. Click Add.

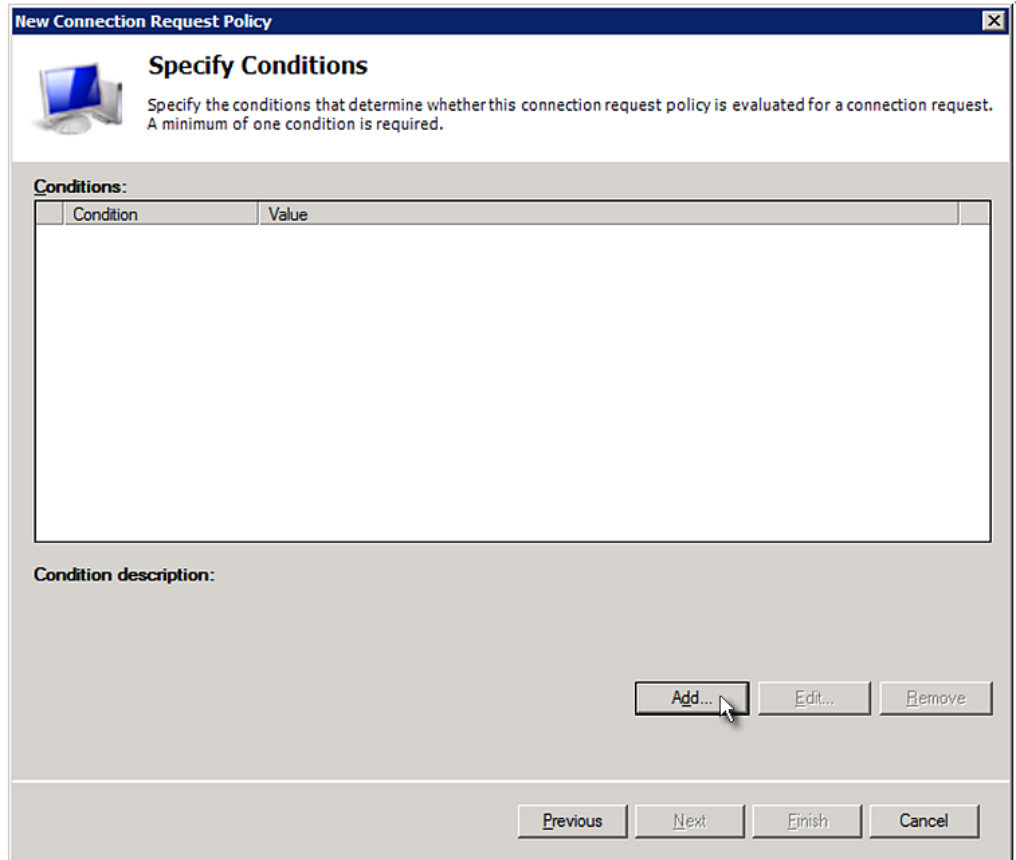

- The "Select condition" dialog appears. Click Add.

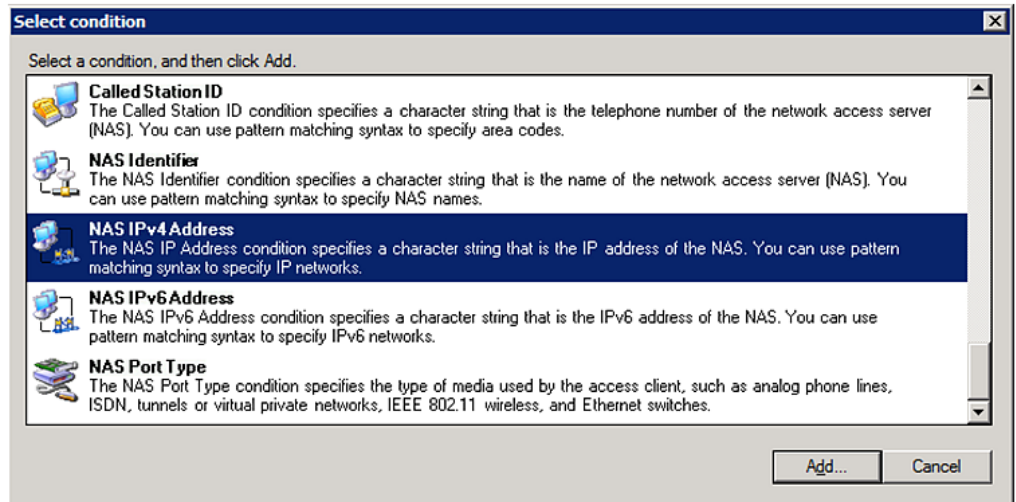

- The NAS IPv4 Address dialog appears. Type the PX3 IP address -- *192.168.56.29*, and click OK.

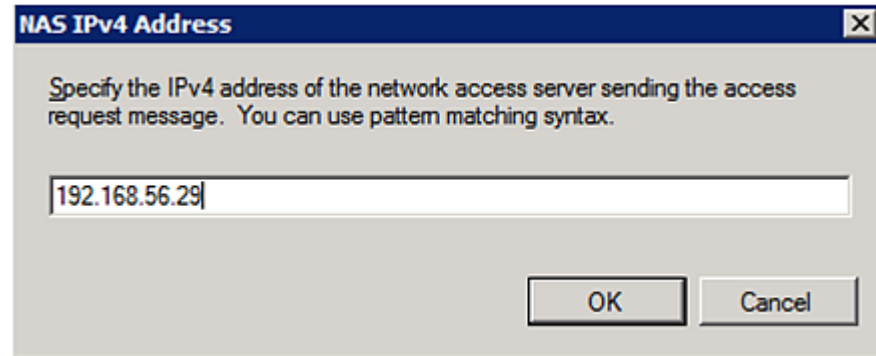

- Click Next in the New Connection Request Policy dialog.

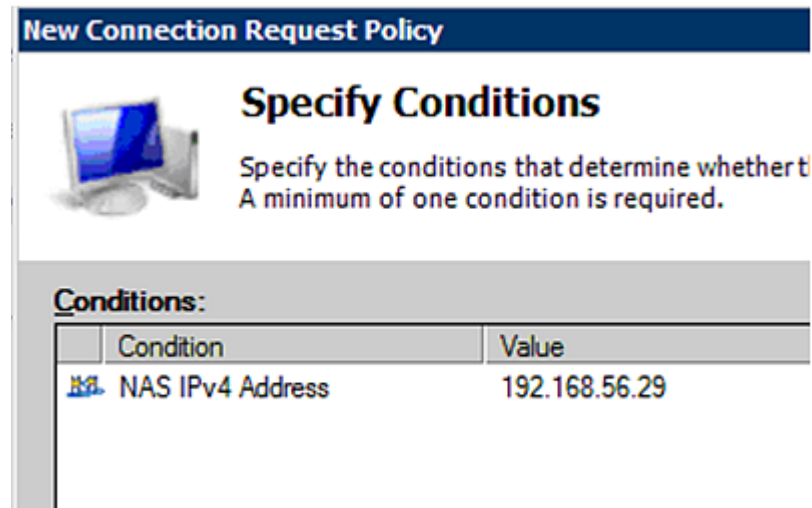

- Select "Authenticate requests on this server" because a local NPS server is used in this example. Then click Next.

Note: Connection Request Forwarding options must match your environment.

The screenshot shows a Windows-style dialog box titled "New Connection Request Policy". The main heading is "Specify Connection Request Forwarding". Below the heading, there is a small icon of a computer and a text box stating: "The connection request can be authenticated by the local server or it can be forwarded to RADIUS servers in a remote RADIUS server group." Below this, a grey bar contains the text: "If the policy conditions match the connection request, these settings are applied." Underneath, the "Settings:" section is divided into two panes. The left pane is titled "Forwarding Connection Request" and is currently empty. The right pane contains the instruction: "Specify whether connection requests are processed locally, are forwarded to remote RADIUS servers for authentication, or are accepted without authentication." There are three radio button options: 1. "Authenticate requests on this server" (which is selected). 2. "Forward requests to the following remote RADIUS server group for authentication:" followed by a dropdown menu showing "<not configured>" and a "New..." button. 3. "Accept users without validating credentials". At the bottom of the dialog, there are four buttons: "Previous", "Next", "Finish", and "Cancel".

9. When the system prompts you to select the authentication method, select the following two options:
 - Override network policy authentication settings
 - CHAP -- the PX3 uses "CHAP" in this example

Note: If your PX3 uses PAP, then select "PAP."

New Connection Request Policy



Specify Authentication Methods

Configure one or more authentication methods required authentication, you must configure an EAP type. If you d Protected EAP.

Override network policy authentication settings

These authentication settings are used rather than the constraints and authentication connections with NAP. you must configure PEAP authentication here.

EAP types are negotiated between NPS and the client in the order in which

EAP Types:

Less secure authentication methods:

- Microsoft Encrypted Authentication version 2 (MS-CHAP-v2)
 - User can change password after it has expired
- Microsoft Encrypted Authentication (MS-CHAP)
 - User can change password after it has expired
- Encrypted authentication (CHAP)
- Unencrypted authentication (PAP, SPAP)
- Allow clients to connect without negotiating an authentication method.

10. Select Standard to the left of the dialog and then click Add.

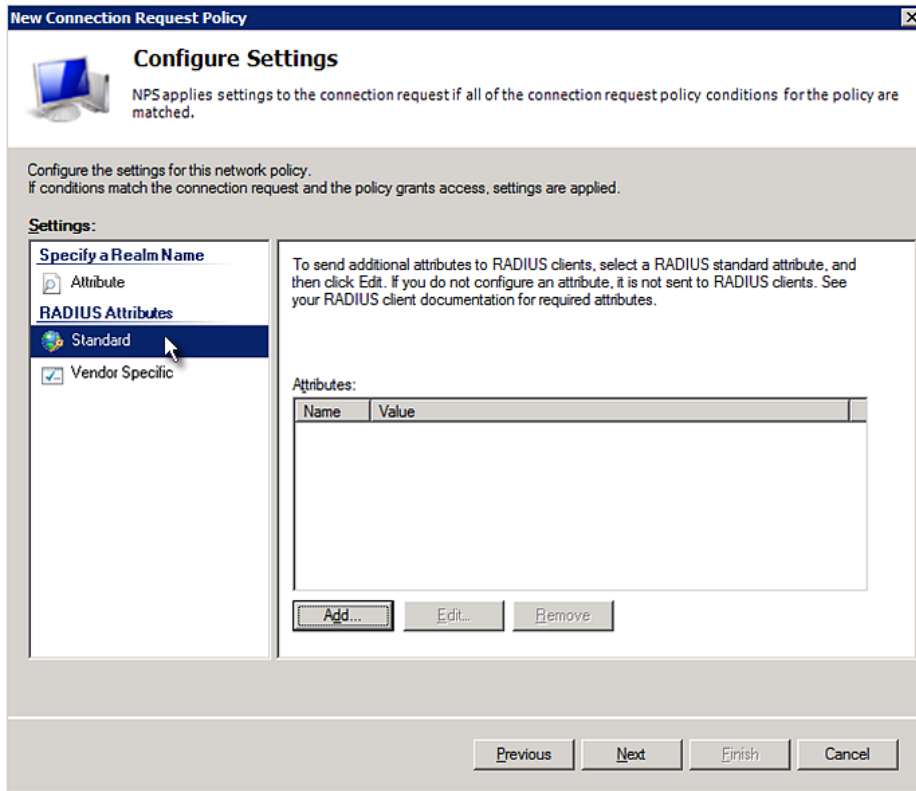

11. Select Filter-Id from the list of attributes and click Add.

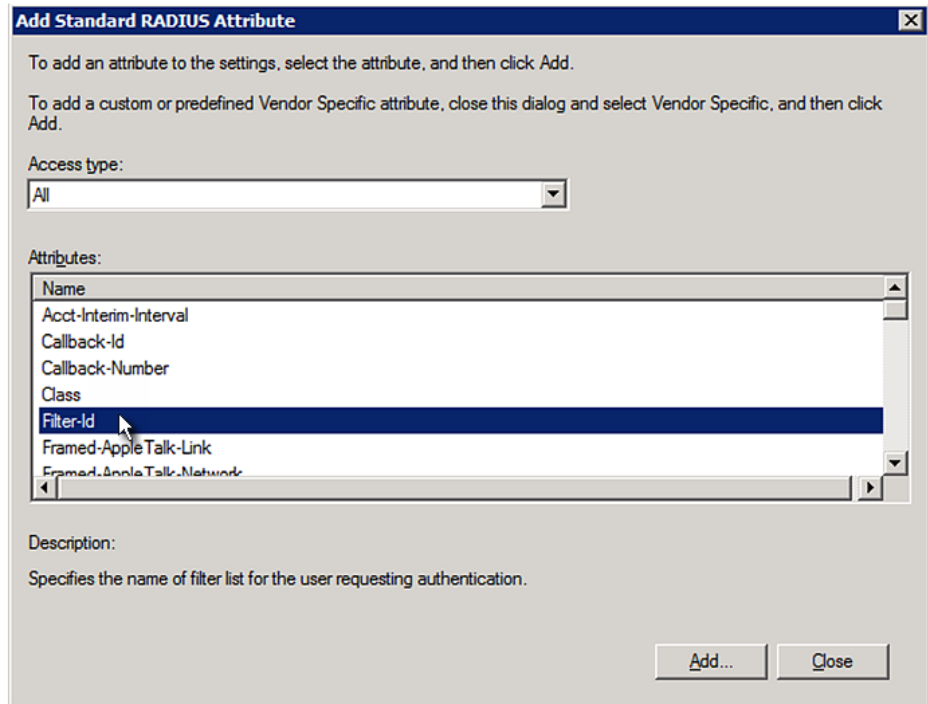

12. In the Attribute Information dialog, click Add.

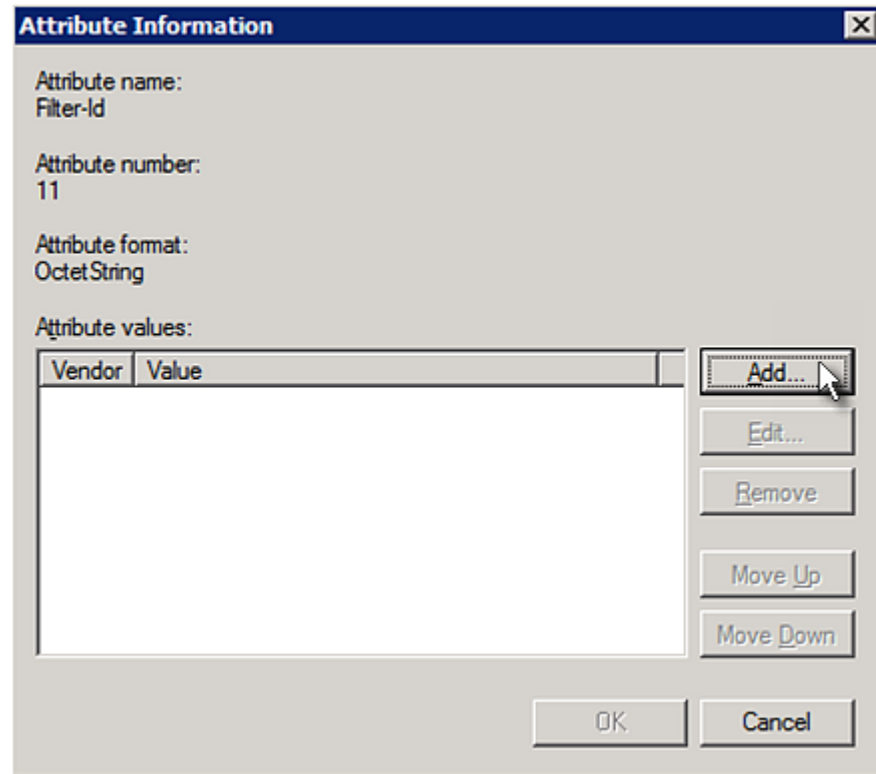

13. Select String, type *Raritan:G{Admin}* in the text box, and then click OK.

Admin inside the curved brackets {} is the existing role on the PX3. It is recommended to use the Admin role to test this configuration. The role name is case sensitive.

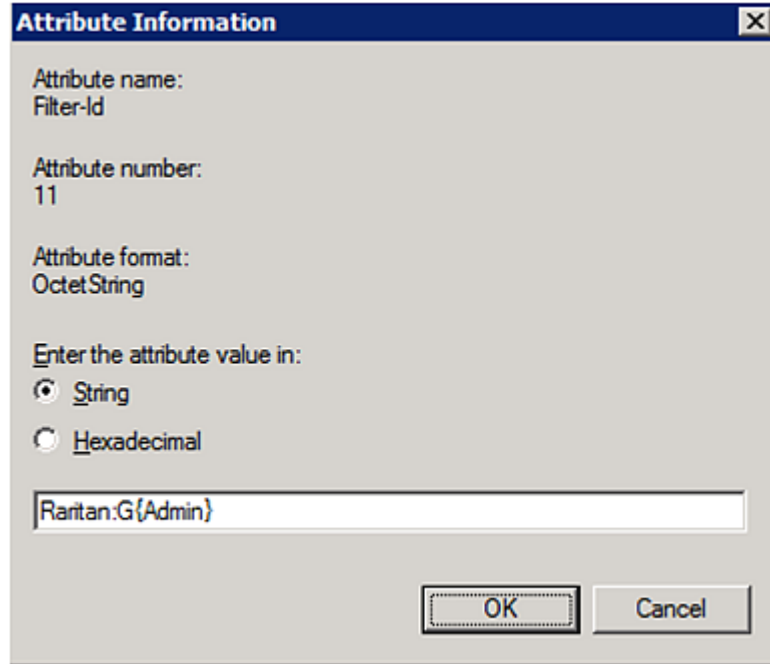

The image shows a dialog box titled "Attribute Information" with a close button (X) in the top right corner. The dialog contains the following fields and options:

- Attribute name: Filter-Id
- Attribute number: 11
- Attribute format: OctetString
- Enter the attribute value in:
 - String
 - Hexadecimal
- Text input field containing: Raritan:G{Admin}
- Buttons: OK and Cancel

14. The new attribute is added. Click OK.

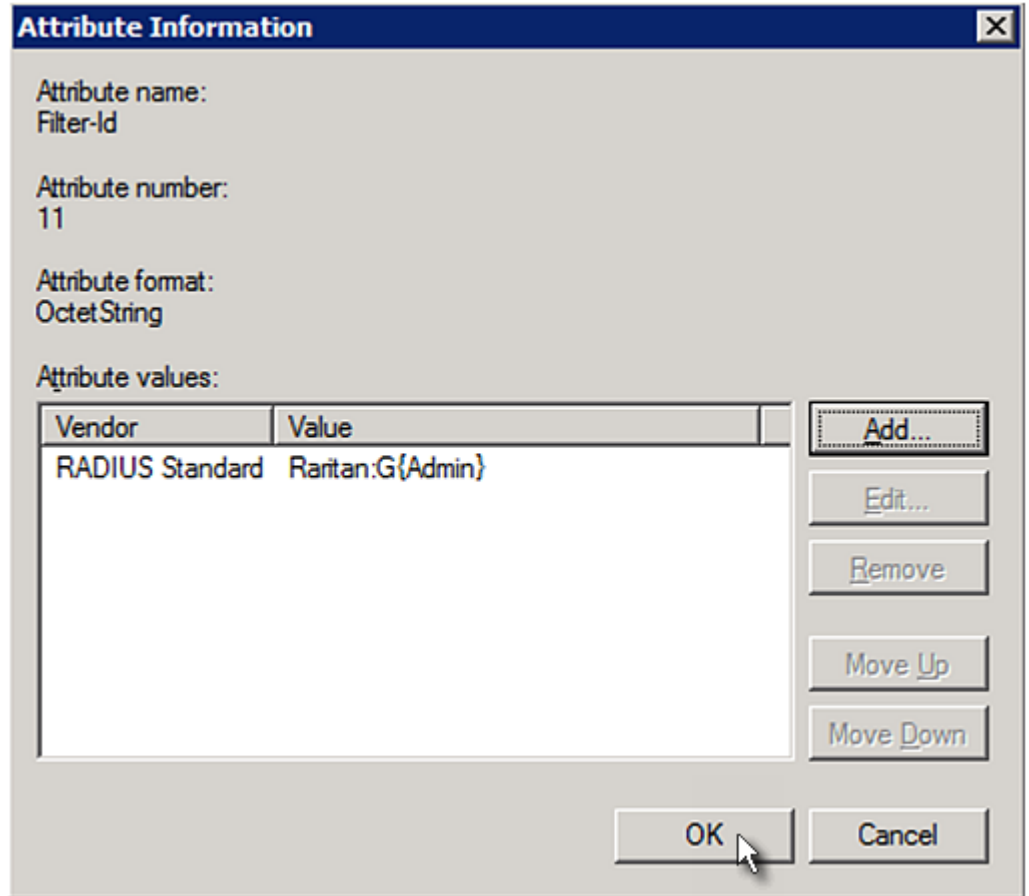

15. Click Next to continue.

New Connection Request Policy

Configure Settings

NPS applies settings to the connection request if all of the connect matched.

Configure the settings for this network policy.
If conditions match the connection request and the policy grants access, settings are a

Settings:

Specify a Realm Name

Attribute

RADIUS Attributes

Standard

Vendor Specific

To send additional attributes to RADIUS client then click Edit. If you do not configure an attr your RADIUS client documentation for require

Attributes:

Name	Value
Filter-Id	Raritan.G{Admin}

16. A summary showing connection request policy settings is displayed. Click Finish to close the dialog.

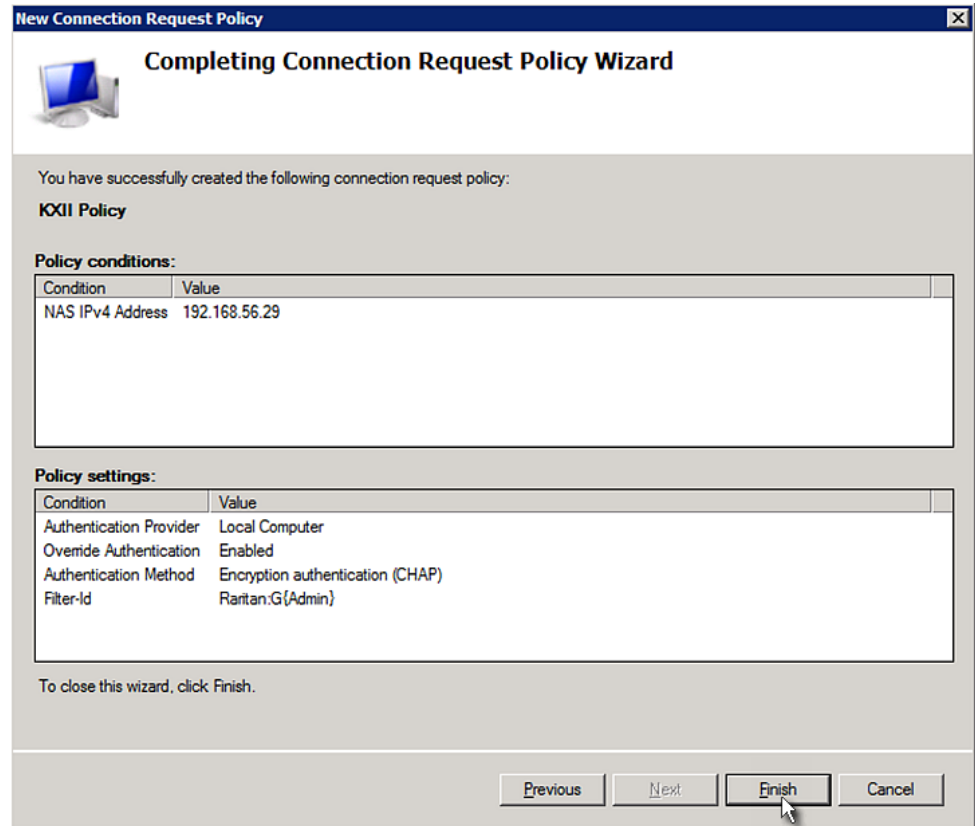

FreeRADIUS Standard Attribute Illustration

With standard attributes, NO dictionary files are required. You simply add all user data, including user names, passwords, and roles, in the following FreeRADIUS path.

```
/etc/raddb/users
```

► **Presumptions in the illustration:**

- User name = steve
- Steve's password = test123
- Steve's roles = Admin and SystemTester

► **To create a user profile for "steve" in FreeRADIUS:**

1. Go to this location: `/etc/raddb/users`.
2. Add the data of the user "steve" by typing the following. Note that the values after the equal sign (=) must be enclosed in double quotes ("").

```
steve Cleartext-Password := "test123"  
Filter-ID = "Raritan:G{Admin}",  
Filter-ID = "Raritan:G{SystemTester}"
```

Vendor-Specific Attributes

You must specify the following properties when using a RADIUS vendor-specific attribute (VSA).

- Vendor code = 13742
- Vendor-assigned attribute number = 26
- Attribute format = String

The syntax of the vendor-specific attribute for specifying one or multiple roles is:

```
Raritan:G{role-name1 role-name2 role-name3}
```

For configuration on NPS, see *NPS VSA Illustration* (on page 653).

For configuration on FreeRADIUS, see *FreeRADIUS VSA Illustration* (on page 665).

NPS VSA Illustration

To configure Windows 2008 NPS with the *vendor-specific attribute*, you must:

- a. Add your PX3 to NPS. See *Step A: Add Your PX3 as a RADIUS Client* (on page 635).
- b. On the NPS, configure connection request policies and the vendor-specific attribute. See *Step B: Configure Connection Policies and Vendor-Specific Attributes* (on page 658).

Some configuration associated with Microsoft Active Directory (AD) is also required for RADIUS authentication. See *AD-Related Configuration* (on page 666).

Step A: Add Your PX3 as a RADIUS Client

The RADIUS implementation on a PX3 follows the standard RADIUS Internet Engineering Task Force (IETF) specification so you must select "RADIUS Standard" as its vendor name when configuring the NPS server.

▶ **Presumptions in the illustration:**

- IP address of your PX3 = 192 . 168 . 56 . 29
- RADIUS authentication port specified for PX3: 1812
- RADIUS accounting port specified for PX3: 1813

▶ **To add your PX3 to the RADIUS NPS:**

1. Choose Start > Administrative Tools > Network Policy Server. The Network Policy Server console window opens.

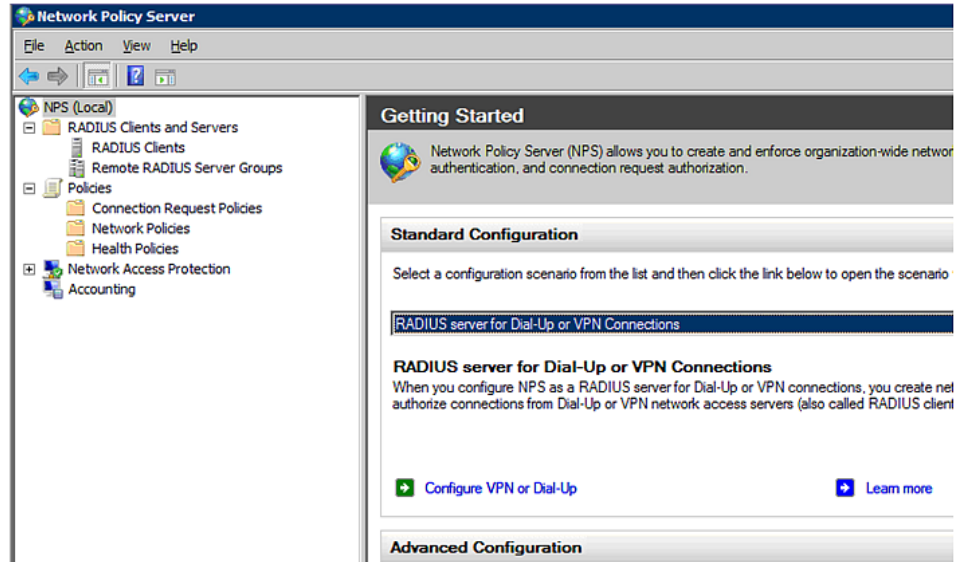

2. Right-click NPS (Local), and select Properties.

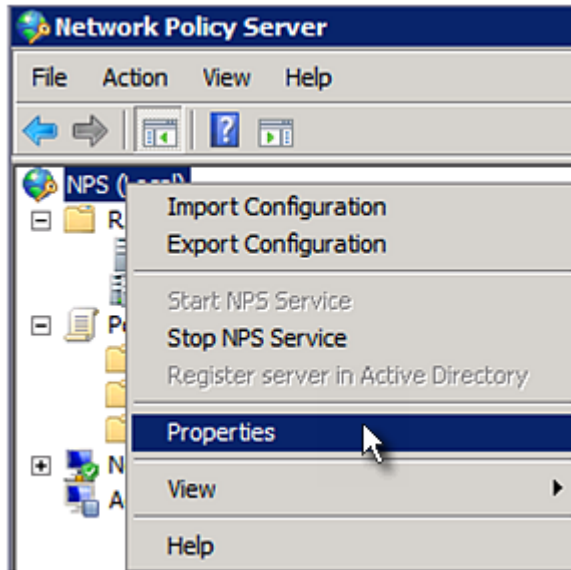

Verify the authentication and accounting port numbers shown in the properties dialog are the same as those specified on your PX3. In this example, they are 1812 and 1813. Then close this dialog.

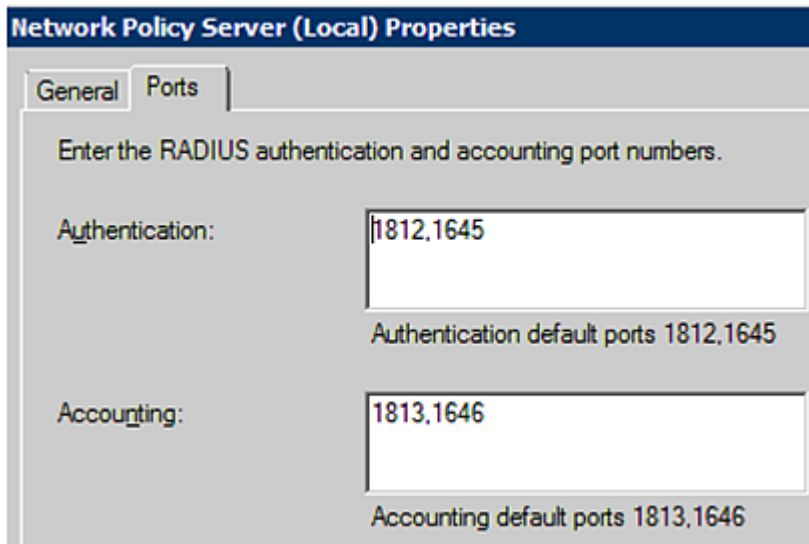

3. Under "RADIUS Clients and Servers," right-click RADIUS Client and select New RADIUS Client. The New RADIUS Client dialog appears.

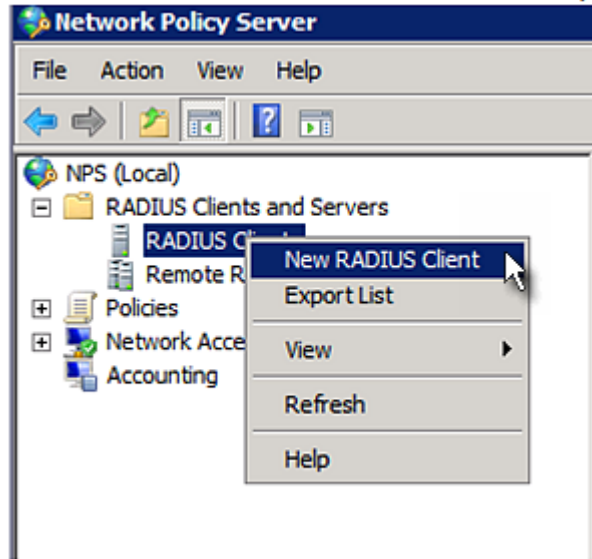

4. Do the following to add your PX3 to NPS:
 - a. Verify the "Enable this RADIUS client" checkbox is selected.
 - b. Type a name for identifying your PX3 in the "Friendly name" field.
 - c. Type *192.168.56.29* in the "Address (IP or DNS)" field.
 - d. Select *RADIUS Standard* in the "Vendor name" field.
 - e. Select the *Manual* radio button.

- f. Type the shared secret in the "Shared secret" and "Confirm shared secret" fields. The shared secret must be the same as the one specified on your PX3.

New RADIUS Client

Enable this RADIUS client

Name and Address

Friendly name:
RaritanDominion

Address (IP or DNS):
192.168.56.29 Verify...

Vendor

Specify RADIUS Standard for most RADIUS clients, or select the RADIUS client vendor from the list.

Vendor name:
RADIUS Standard

Shared Secret

To manually type a shared secret, click Manual. To automatically generate a shared secret, click Generate. You must configure the RADIUS client with the same shared secret entered here. Shared secrets are case-sensitive.

Manual Generate

Shared secret:
●●●●●●

Confirm shared secret:
●●●●●●

Additional Options

Access-Request messages must contain the Message-Authenticator attribute

RADIUS client is NAP-capable

OK Cancel

- 5. Click OK.

Step B: Configure Connection Policies and Vendor-Specific Attributes

You need to configure the following for connection request policies:

- IP address or host name of the PX3
 - Connection request forwarding method
 - Authentication method(s)
 - Standard RADIUS attributes
- ▶ **Presumptions in the illustration:**
- IP address of your PX3 = 192 . 168 . 56 . 29
 - *Local* NPS server is used
 - RADIUS protocol selected on your PX3 = CHAP
 - Existing roles of your PX3 = Admin, User and SystemTester

▶ **Illustration:**

1. Open the NPS console, and expand the Policies folder.

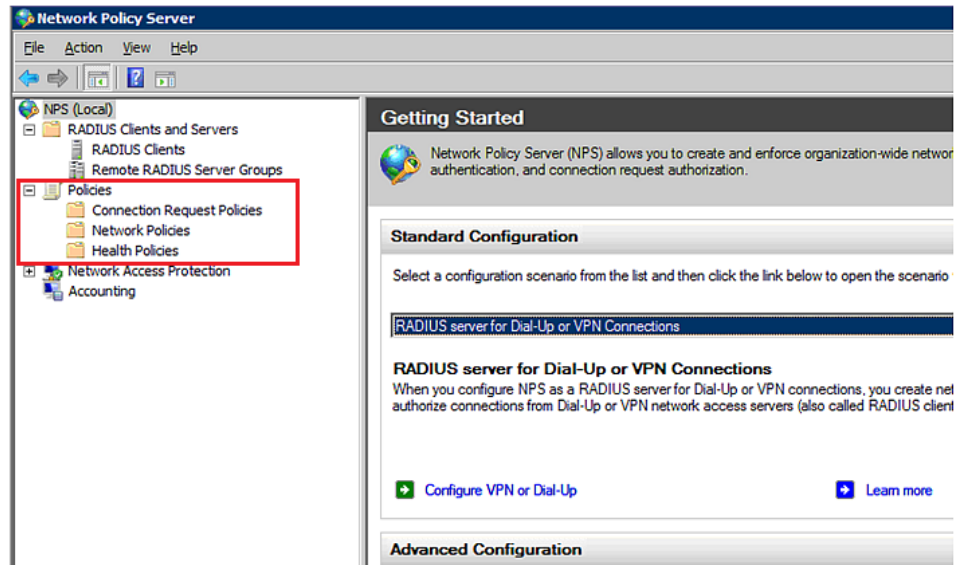

2. Right-click Connection Request Policies and select New. The New Connection Request Policy dialog appears.

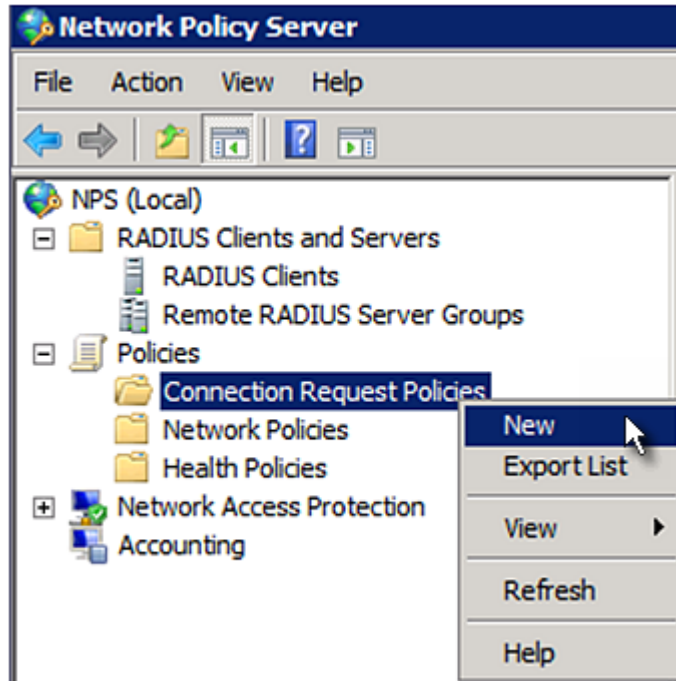

3. Type a descriptive name for identifying this policy in the "Policy name" field.

- You can leave the "Type of network access server" field to the default -- Unspecified.

New Connection Request Policy



Specify Connection Request Policy Name

You can specify a name for your connection request policy and it will be applied.

Policy name:

Network connection method
Select the type of network access server that sends the connection request to NPS.
type or Vendor specific.

Type of network access server:

Vendor specific:

4. Click Next to show the "Specify Conditions" screen. Click Add.

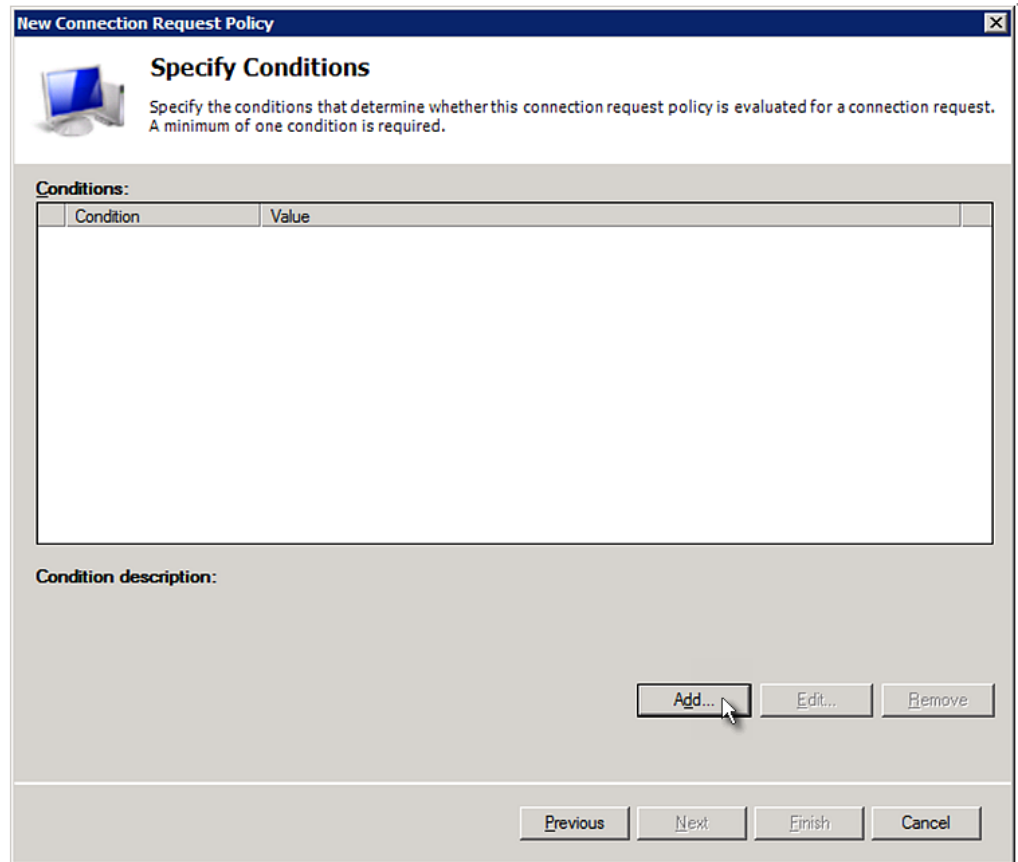

5. The "Select condition" dialog appears. Click Add.

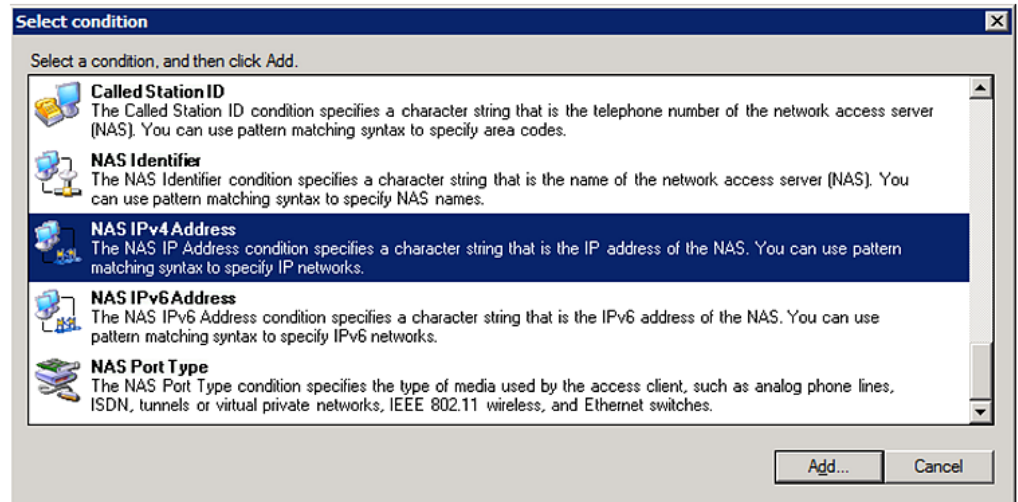

- The NAS IPv4 Address dialog appears. Type the PX3 IP address -- *192.168.56.29*, and click OK.

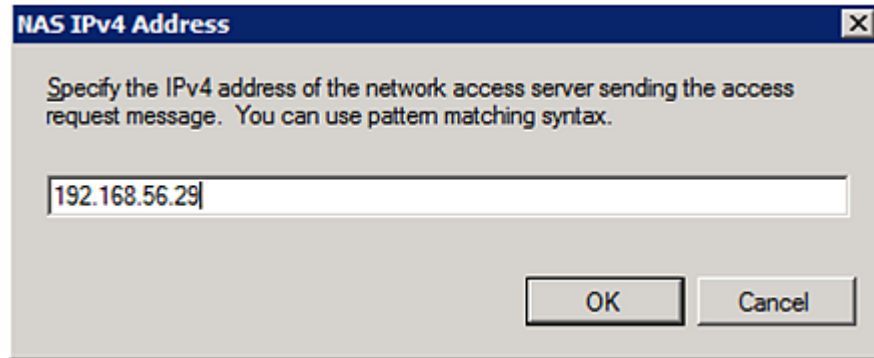

- Click Next in the New Connection Request Policy dialog.

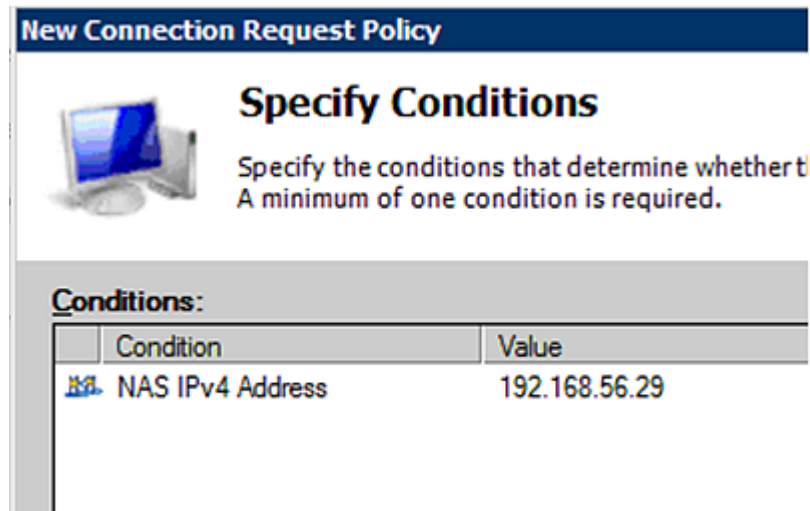

- Select "Authenticate requests on this server" because a local NPS server is used in this example. Then click Next.

Note: Connection Request Forwarding options must match your environment.

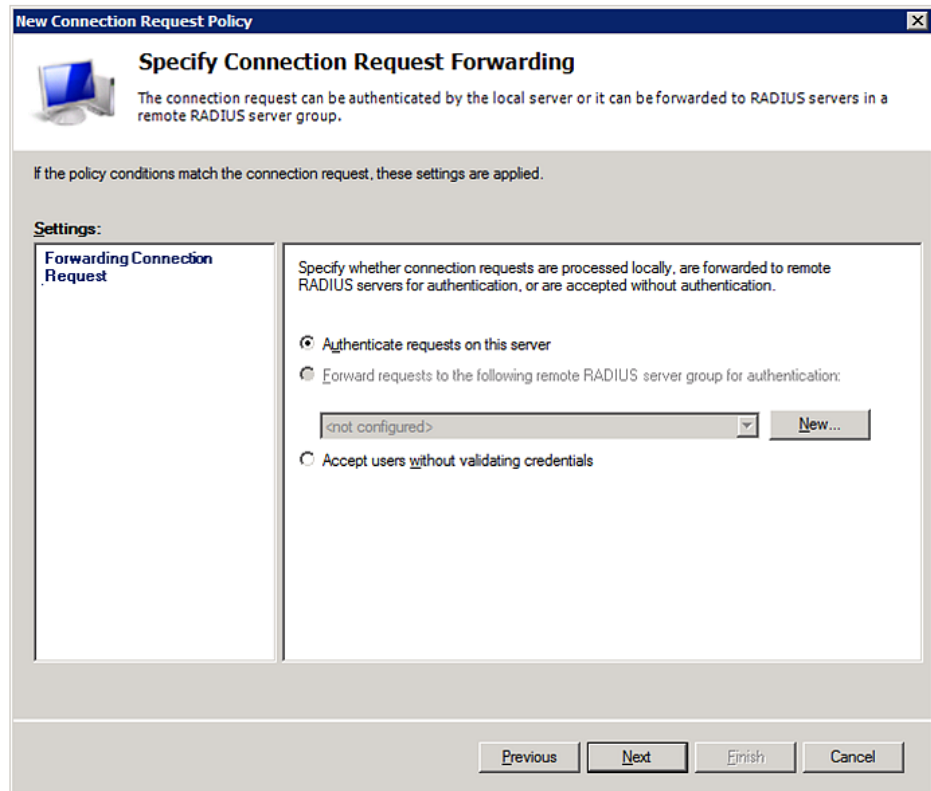

9. When the system prompts you to select the authentication method, select the following two options:
 - Override network policy authentication settings
 - CHAP -- the PX3 uses "CHAP" in this example

Note: If your PX3 uses PAP, then select "PAP."

New Connection Request Policy



Specify Authentication Methods

Configure one or more authentication methods required authentication, you must configure an EAP type. If you d Protected EAP.

Override network policy authentication settings

These authentication settings are used rather than the constraints and authentication connections with NAP. you must configure PEAP authentication here.

EAP types are negotiated between NPS and the client in the order in which

EAP Types:

Less secure authentication methods:

Microsoft Encrypted Authentication version 2 (MS-CHAP-v2)

User can change password after it has expired

Microsoft Encrypted Authentication (MS-CHAP)

User can change password after it has expired

Encrypted authentication (CHAP)

Unencrypted authentication (PAP, SPAP)

Allow clients to connect without negotiating an authentication method.

10. Select Vendor Specific to the left of the dialog, and click Add. The Add Vendor Specific Attribute dialog appears.
11. Select Custom in the Vendor field, and click Add. The Attribute Information dialog appears.
12. Click Add, and the Vendor-Specific Attribute Information dialog appears.
13. Click "Enter Vendor Code" and type *13742*.
14. Select "Yes, it conforms" to indicate that the custom attribute conforms to the RADIUS Request For Comment (RFC).
15. Click Configure Attribute, and then:
 - a. Type *26* in the "Vendor-assigned attribute number" field.
 - b. Select String in the "Attribute format" field.
 - c. Type *Raritan:G{Admin User SystemTester}* in the "Attribute value" field. In this example, three roles 'Admin,' 'User' and 'SystemTester' are specified inside the curved brackets {}.

Note that multiple roles are separated with a space.

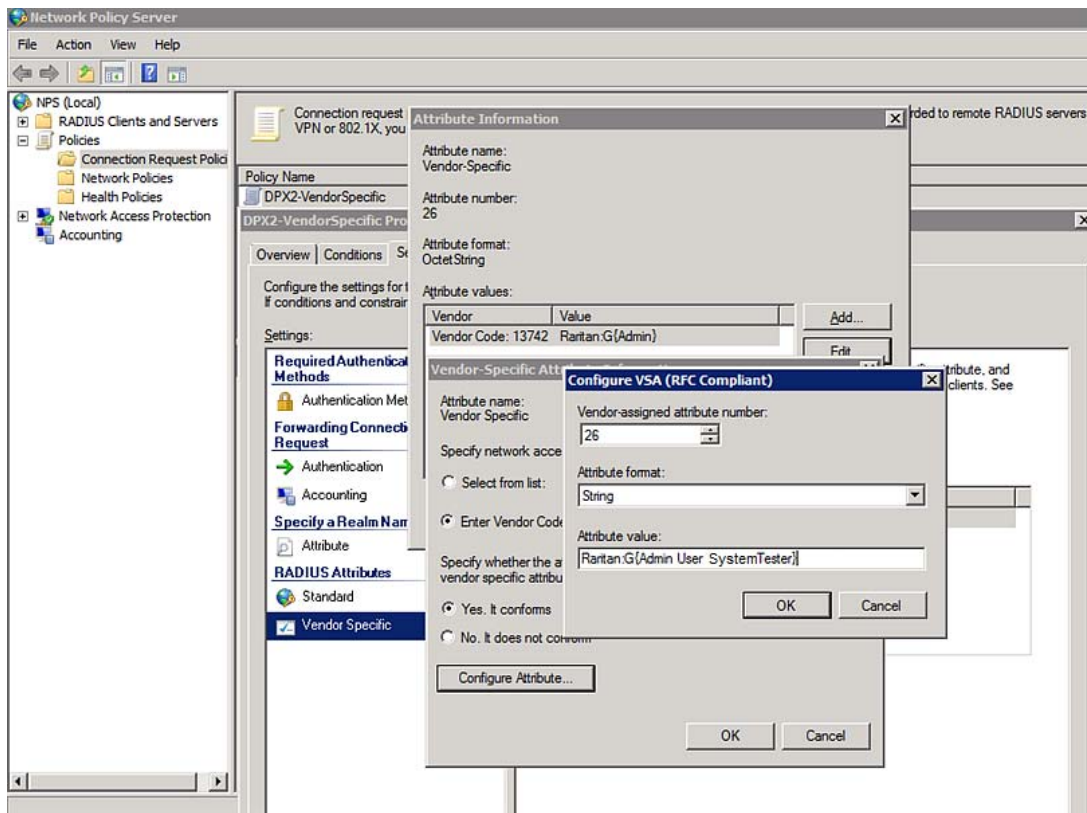

16. Click OK.

FreeRADIUS VSA Illustration

A vendor-specific dictionary file is required for the vendor-specific-attribute configuration on FreeRADIUS. Therefore, there are two major configuration steps.

- a. Use a dictionary to define the Raritan vendor-specific attribute
- b. Add all user data, including user names, passwords, and roles

► Presumptions in the illustration:

- Raritan attribute = Raritan-User-Roles
- User name = steve
- Steve's password = test123
- Steve's roles = Admin, User and SystemTester

► Step A -- define the vendor-specific attribute in FreeRADIUS:

1. Go to this location: `/etc/raddb/dictionary`.
2. Type the following in the Raritan dictionary file.

```
VENDOR Raritan 13742
BEGIN-VENDOR Raritan
ATTRIBUTE Raritan-User-Roles 26 string
END-VENDOR Raritan
```

► **Step B -- create a user profile for "steve" in FreeRADIUS:**

1. Go to this location: /etc/raddb/users.
2. Add the data of the user "steve" by typing the following. Note that the values after the equal sign (=) must be enclosed in double quotes ("").

```
steve Cleartext-Password := "test123"
Raritan-PDU-User-Roles = "Raritan:G{Admin User SystemTester}"
```

AD-Related Configuration

When RADIUS authentication is intended, make sure you also configure the following settings related to Microsoft Active Directory (AD):

- Register the NPS server in AD
- Configure remote access permission for users in AD

The NPS server is registered in AD only when NPS is configured for the FIRST time and user accounts are created in AD.

If CHAP authentication is used, you must enable the following feature for user accounts created in AD:

- Store password using reversible encryption

Important: Reset the user password if the password is set before you enable the "Store password using reversible encryption" feature.

► **To register NPS:**

1. Open the NPS console.

2. Right-click NPS (Local) and select "Register server in Active Directory."

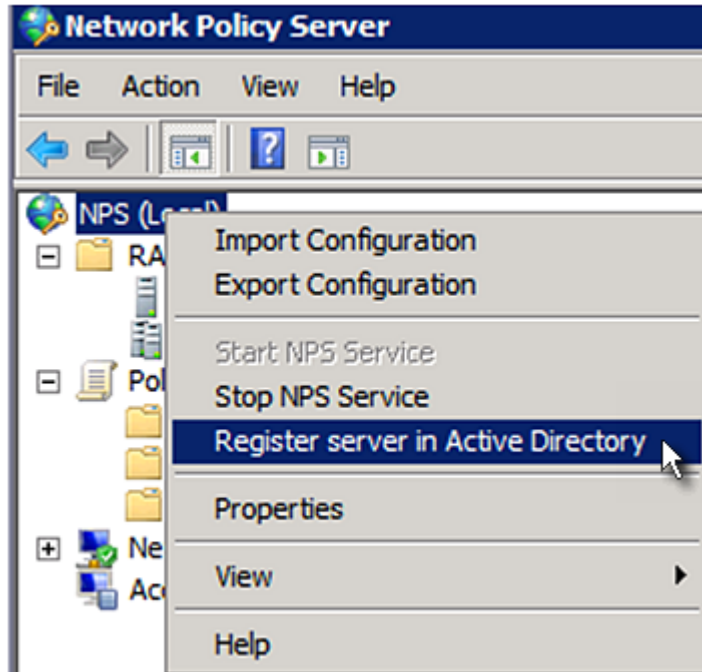

3. Click OK, and then OK again.

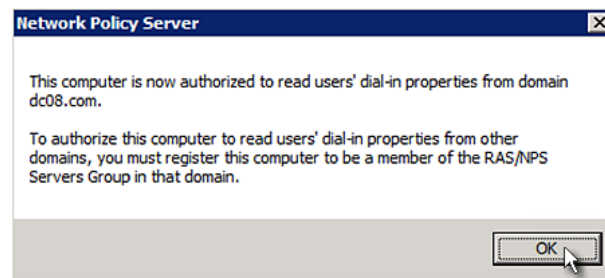
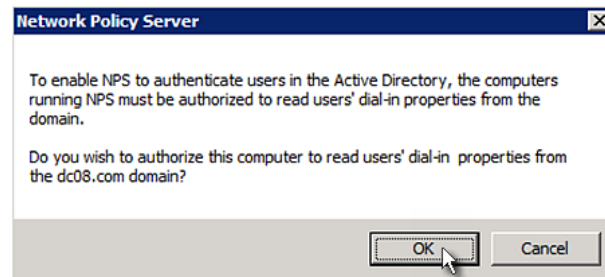

► To grant PX3 users remote access permission:

1. Open Active Directory Users and Computers.

2. Open the properties dialog of the user whom you want to grant the access permission.
3. Click the Dial-in tab and select the "Allow access" checkbox.

The screenshot shows the 'Dial-in' tab of the user properties dialog. The 'Network Access Permission' section is expanded, showing three radio button options: 'Allow access' (selected), 'Deny access', and 'Control access through NPS Network Policy'. Below this is a 'Verify Caller-ID' checkbox with an empty text field. The 'Callback Options' section has three radio button options: 'No Callback' (selected), 'Set by Caller (Routing and Remote Access Service only)', and 'Always Callback to:' with an empty text field. The 'Assign Static IP Addresses' section has a checkbox and a 'Static IP Addresses...' button. The 'Apply Static Routes' section has a checkbox and a 'Static Routes...' button. At the bottom are 'OK', 'Cancel', 'Apply', and 'Help' buttons.

► **To enable reversible encryption for CHAP authentication:**

1. Open Active Directory Users and Computers.
2. Open the properties dialog of the user that you want to configure.

3. Click the Account tab and select the "Store password using reversible encryption" checkbox.

The screenshot shows the 'Account' tab in the Local Security and Authentication console. The 'Account options' section is expanded, and the 'Store password using reversible encryption' checkbox is checked. Other options include 'User must change password at next logon', 'User cannot change password', and 'Password never expires', all of which are unchecked. The 'Account expires' section shows the account set to 'Never' expire.

Member Of	Dial-in	Environment	Sessions
Remote control	Terminal Services Profile		COM+
General	Address	Account	Profile
Telephones	Organization		

User logon name:
[] []

User logon name (pre-Windows 2000):
DC08\ Administrator

[Logon Hours...] [Log On To...]

Unlock account

Account options:

- User must change password at next logon
- User cannot change password
- Password never expires
- Store password using reversible encryption

Account expires

Never

End of: Saturday, May 23, 2009

[OK] [Cancel] [Apply] [Help]

Appendix K Additional PX3 Information

In This Chapter

RJ45-to-DB9 Cable Requirements for Modem Connections (for iX7™ Only)	670
Reserving IP Addresses in DHCP Servers	671
Sensor Threshold Settings	675
PDView App for Viewing the PX3	682
Altitude Correction Factors	684
Unbalanced Current Calculation	685
Data for BTU Calculation	686
Ways to Probe Existing User Profiles	687
Raritan Training Website	687
Role of a DNS Server	688
Cascading Troubleshooting	688
Browsing through the Online Help	694

RJ45-to-DB9 Cable Requirements for Modem Connections (for iX7™ Only)

An RJ45-to-DB9 adapter/cable is required for connecting a modem to an iX7™ PDU.

A third party RJ45-to-DB9 adapter/cable needs to meet the following requirements.

- RJ-45 to "DB9 male"
- RX/TX and according control pins are NOT crossed
- With the following pin assignments:

Pin signal	DB9 pin No.	RJ-45 pin No.
DCD	1	5
RxD	2	6
TxD	3	3
DTR	4	2
GND	5	4
DSR	6	7
RTS	7	1
CTS	8	8
RIR	9	N/A

*Note: The RJ45-to-DB9 adapter/cable used for connecting modems CANNOT be used to connect the iX7™ to a computer. See **RJ45-to-DB9 Cable Requirements for Computer Connections (for iX7™ Only)** (on page 30).*

Reserving IP Addresses in DHCP Servers

The PX3 uses its serial number as the client identifier in the DHCP request. Therefore, to successfully reserve an IP address for the PX3 in a DHCP server, use the PX3 device's serial number as the unique ID instead of the MAC address.

Since all network interfaces of the PX3 can be simultaneously enabled and configured with diverse static IP addresses, the client identifier of each network interface is different. The main difference is the absence/presence of a suffix, which is the interface name added to the end of the serial number. The table below lists the client identifiers of all network interfaces.

Interface	Client identifier
ETHERNET (PX3)	serial number
ETH1 (PX3-iX7)	serial number
ETH2 (PX3-iX7)	serial number plus the uppercase suffix "-ETH2"
WIRELESS	serial number plus the uppercase suffix "-WIRELESS"
BRIDGE	serial number

You can reserve the IP addresses of more than one interfaces in the DHCP server if preferred. Note that you must choose/configure the bridge interface if your PX3 is set to the bridging mode.

Important: In the bridging mode, only the IP parameters of the BRIDGE interface function. The IP parameters of the ETHERNET (or ETH1/ETH2) and WIRELESS interfaces do NOT function.

Reserving IP in Windows

To reserve the IP address of any network interface in the Windows DHCP server, you must convert that interface's client identifier into *hexadecimal* ASCII codes.

For each interface's client identifier, see *Reserving IP Addresses in DHCP Servers* (on page 671).

In the following illustration, it is assumed that the PX3 serial number is PEG1A00003.

► **Windows IP address reservation illustration:**

1. Convert the client identifier of the desired network interface into ASCII codes (*hexadecimal*).

Interface	Client identifier conversion
ETHERNET (PX3)	PEG1A00003 = 50 45 47 31 41 30 30 30 30 33
ETH1 (PX3-iX7)	PEG1A00003 = 50 45 47 31 41 30 30 30 30 33
ETH2 (PX3-iX7)	PEG1A00003-ETH2 = 50 45 47 31 41 30 30 30 30 33 2D 45 54 48 32 <ul style="list-style-type: none"> ▪ The suffix comprising the dash symbol and the word "ETH2" is also converted.
WIRELESS	PEG1A00003-WIRELESS = 50 45 47 31 41 30 30 30 30 33 2D 57 49 52 45 4C 45 53 53 <ul style="list-style-type: none"> ▪ The suffix comprising the dash symbol and the word "WIRELESS" is also converted.
BRIDGE	PEG1A00003 = 50 45 47 31 41 30 30 30 30 33

2. In your DHCP server, bring up the New Reservation dialog, and separate the converted ASCII codes with spaces.

For example, to reserve the IP address of the ETHERNET or ETH1 interface, enter the following data in the dialog.

Field	Data entered
IP address	The IP address you want to reserve.
MAC address	The following ASCII codes. 50 45 47 31 41 30 30 30 30 33
Other fields	Configure as needed.

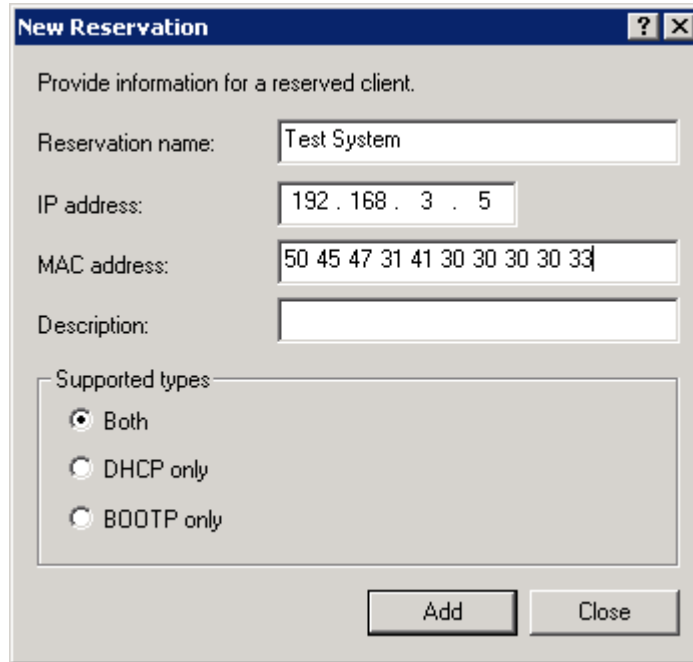

Reserving IP in Linux

There are two methods to reserve the IP address of any network interface in the standard Linux DHCP server (ISC DHCP server):

- Convert an interface's client identifier into *hexadecimal* ASCII codes.
- Use an interface's original client identifier without converting it into ASCII codes.

For each interface's client identifier, see *Reserving IP Addresses in DHCP Servers* (on page 671).

In the following illustrations, it is assumed that the PX3 serial number is PEG1A00003, and the IP address you want to reserve is 192.168.20.1.

► **Illustration with ASCII code conversion:**

1. Convert the client identifier of the desired network interface into ASCII codes (*hexadecimal*).

Interface	Client identifier conversion
ETHERNET (PX3)	PEG1A00003 = 50 45 47 31 41 30 30 30 30 33
ETH1 (PX3-iX7)	PEG1A00003 = 50 45 47 31 41 30 30 30 30 33

Interface	Client identifier conversion
ETH2 (PX3-iX7)	PEG1A00003-ETH2 = 50 45 47 31 41 30 30 30 30 33 2D 45 54 48 32 <ul style="list-style-type: none"> The suffix comprising the dash symbol and the word "ETH2" is also converted.
WIRELESS	PEG1A00003-WIRELESS = 50 45 47 31 41 30 30 30 30 33 2D 57 49 52 45 4C 45 53 53 <ul style="list-style-type: none"> The suffix comprising the dash symbol and the word "WIRELESS" is also converted.
BRIDGE	PEG1A00003 = 50 45 47 31 41 30 30 30 30 33

- Separate the converted ASCII codes with a colon, and a prefix "00:" must be added to the beginning of the converted codes.

For example, the *converted* client identifier of the ETHERNET or ETH1 interface looks like the following:

```
00:50:45:47:31:41:30:30:30:30:33
```

- Now enter the converted client identifier with the following syntax.

```
host mypx {
option dhcp-client-identifier = 00:50:45:47:31:41:30:30:30:30:33;
fixed-address 192.168.20.1;
}
```

► **Illustration without ASCII code conversion:**

- Use the original client identifier of the desired network interface. DO NOT convert them into ASCII codes.
- A prefix "\000" must be added to the beginning of the client identifier. For example, the client identifier of the ETHERNET or ETH1 interface looks like the following:

```
\000PEG1A00003
```

- Now enter the original client identifier with the following syntax. The client identifier is enclosed in quotation marks.

```
host mypx {
option dhcp-client-identifier = "\000PEG1A00003";
fixed-address 192.168.20.1;
}
```

Sensor Threshold Settings

This section explains the thresholds settings for a numeric sensor.

Lower Critical	<input checked="" type="checkbox"/>	<input type="text" value="0"/>	<input type="text"/>
Lower Warning	<input checked="" type="checkbox"/>	<input type="text" value="0"/>	<input type="text"/>
Upper Warning	<input checked="" type="checkbox"/>	<input type="text" value="0"/>	<input type="text"/>
Upper Critical	<input checked="" type="checkbox"/>	<input type="text" value="0"/>	<input type="text"/>
Deassertion Hysteresis		<input type="text" value="0"/>	<input type="text"/>
Assertion Timeout		<input type="text" value="0"/>	<input type="text" value="Samples"/>

Thresholds and Sensor States

A numeric sensor has four thresholds: Lower Critical, Lower Warning, Upper Warning and Upper Critical.

The threshold settings determine how many sensor states are available for a certain sensor and the range of each sensor state. The diagram below shows how each threshold relates to each state.

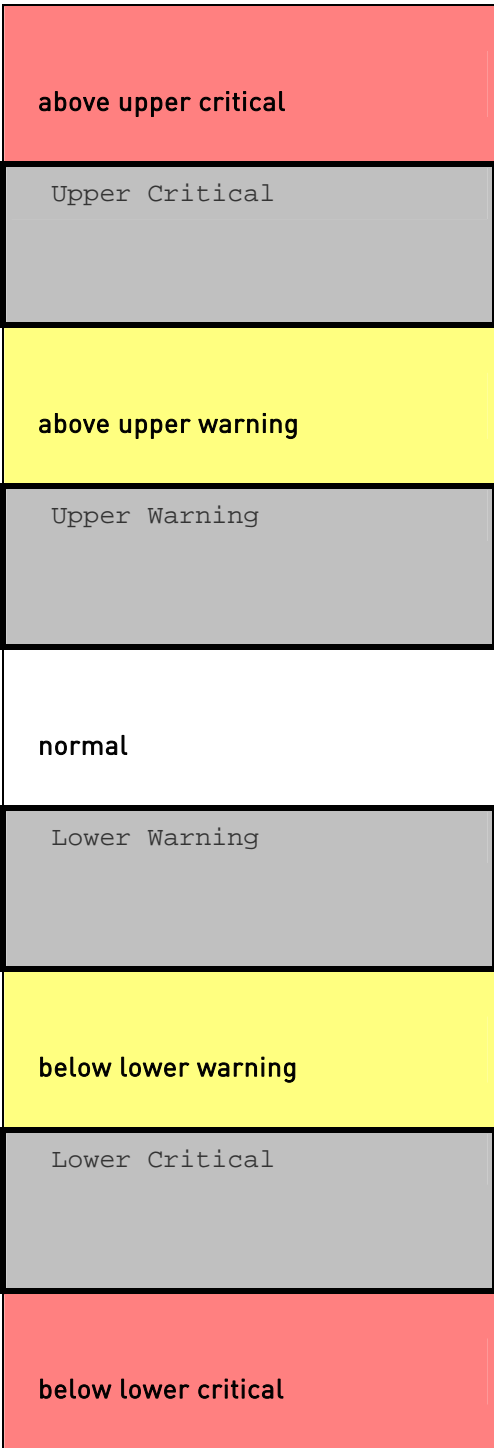

▶ Available sensor states:

The more thresholds are enabled for a sensor, the more sensor states are available for it. The "normal" state is always available regardless of whether any threshold is enabled.

For example:

- When a sensor only has the Upper Critical threshold enabled, it has two sensor states: normal and above upper critical.
- When a sensor has both the Upper Critical and Upper Warning thresholds enabled, it has three sensor states: normal, above upper warning, and above upper critical.

States of "above upper warning" and "below lower warning" are warning states to call for your attention.

States of "above upper critical" and "below lower critical" are critical states that require you to immediately handle.

► **Range of each available sensor state:**

The value of each enabled threshold determines the reading range of each available sensor state. For details, see *Yellow- or Red-Highlighted Sensors* (on page 180).

"To Assert" and Assertion Timeout

If multiple sensor states are available for a specific sensor, the PX3 asserts a state for it whenever a bad state change occurs.

► **To assert a state:**

To assert a state is to announce a new, "worse" state.

Below are bad state changes that cause the PX3 to assert.

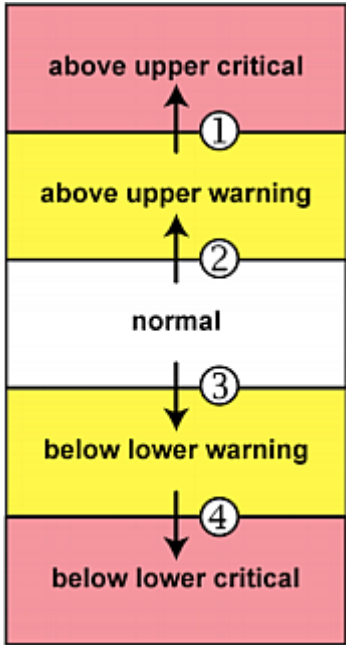

- 1. above upper warning --> above upper critical
- 2. normal --> above upper warning
- 3. normal --> below lower warning
- 4. below lower warning --> below lower critical

► **Assertion Timeout:**

Lower Critical	<input checked="" type="checkbox"/>	0	
Lower Warning	<input checked="" type="checkbox"/>	0	
Upper Warning	<input checked="" type="checkbox"/>	0	
Upper Critical	<input checked="" type="checkbox"/>	0	
Deassertion Hysteresis		0	
Assertion Timeout		0	Samples

In the threshold settings, the Assertion Timeout field postpones or even cancels the "assertion" action. It determines how long a sensor must be in the "worse" new state before the PX3 triggers the "assertion" action. If that sensor changes its state again within the specified wait time, the PX3 does NOT assert the worse state.

To disable the assertion timeout, set it to 0 (zero).

Note: For most sensors, the measurement unit in the "Assertion Timeout" field is sample. Sensors are measured every second, so the timing of a sample is equal to a second. BCM2 is an exception to this, with a sample of 3 seconds.

► **How "Assertion Timeout" is helpful:**

If you have created an event rule that instructs the PX3 to send notifications for assertion events, setting the "Assertion Timeout" is helpful for eliminating a number of notifications that you may receive in case the sensor's readings fluctuate around a certain threshold.

Assertion Timeout Example for Temperature Sensors

Assumption:

Upper Warning threshold is enabled.
Upper Warning = 25 (degrees Celsius)
Assertion Timeout = 5 samples (that is, 5 seconds)

When a temperature sensor's reading exceeds 25 degrees Celsius, moving from the "normal" range to the "above upper warning" range, the PX3 does NOT immediately announce this warning state. Instead it waits for 5 seconds, and then does either of the following:

- If the temperature remains above 25 degrees Celsius in the "above upper warning" range for 5 seconds, the PX3 performs the "assertion" action to announce the "above upper warning" state.
- If the temperature drops below 25 degrees Celsius within 5 seconds, the PX3 does NOT perform the "assertion" action.

"To De-assert" and Deassertion Hysteresis

After the PX3 asserts a worse state for a sensor, it may de-assert that state later on if the readings improve.

► **To de-assert a state:**

To de-assert a state is to announce the end of the previously-asserted worse state.

Below are good state changes that cause the PX3 to de-assert the previous state.

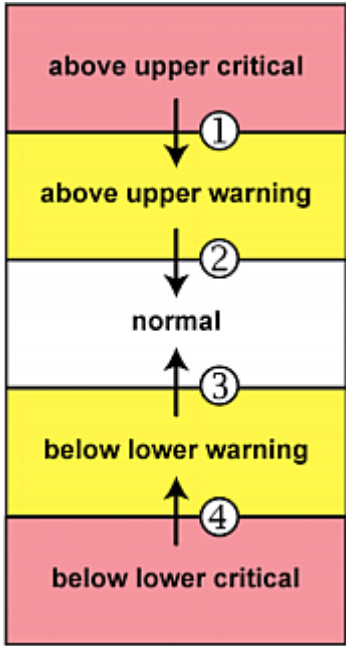

- 1. above upper critical --> above upper warning
- 2. above upper warning --> normal
- 3. below lower warning --> normal
- 4. below lower critical --> below lower warning

► **Deassertion Hysteresis:**

Lower Critical	<input checked="" type="checkbox"/>	0	
Lower Warning	<input checked="" type="checkbox"/>	0	
Upper Warning	<input checked="" type="checkbox"/>	0	
Upper Critical	<input checked="" type="checkbox"/>	0	
Deassertion Hysteresis		0	
Assertion Timeout		0	Samples

In the threshold settings, the Deassertion Hysteresis field determines a new level to trigger the "deassertion" action.

This function is similar to a thermostat, which instructs the air conditioner to turn on the cooling system when the temperature exceeds a pre-determined level. "Deassertion Hysteresis" instructs the PX3 to de-assert the worse state for a sensor only when that sensor's reading reaches the pre-determined "deassertion" level.

For upper thresholds, this "deassertion" level is a decrease against each threshold. For lower thresholds, this level is an increase to each threshold. The absolute value of the decrease/increase is exactly the hysteresis value.

For example, if Deassertion Hysteresis = 2, then:

- Upper Critical = 33, so its "deassertion" level = $33 - 2 = 31$.
- Upper Warning = 25, so its "deassertion" level = $25 - 2 = 23$.
- Lower Critical = 10, so its "deassertion" level = $10 + 2 = 12$.
- Lower Warning = 18, so its "deassertion" level = $18 + 2 = 20$.

To use each threshold as the "deassertion" level instead of determining a new level, set the Deassertion Hysteresis to 0 (zero).

► **How "Deassertion Hysteresis" is helpful:**

If you have created an event rule that instructs the PX3 to send notifications for deassertion events, setting the "Deassertion Hysteresis" is helpful for eliminating a number of notifications that you may receive in case a sensor's readings fluctuate around a certain threshold.

Deassertion Hysteresis Example for Temperature Sensors

Assumption:

Upper Warning threshold is enabled.
 Upper Warning = 20 (degrees Celsius)
 Deassertion Hysteresis = 3 (degrees Celsius)
 "Deassertion" level = $20-3 = 17$ (degrees Celsius)

When the PX3 detects that a temperature sensor's reading drops below 20 degrees Celsius, moving from the "above upper warning" range to the "normal" range, either of the following may occur:

- If the temperature falls between 20 and 17 degrees Celsius, the PX3 does NOT perform the "deassertion" action.
- If the temperature drops to 17 degrees Celsius or lower, the PX3 performs the "deassertion" action to announce the end of the "above upper warning" state.

PDView App for Viewing the PX3

Raritan has developed an app that can turn your iOS or Android mobile device into a local display for the PX3.

This app is called PDView and it can be downloaded for free.

PDView is especially helpful when your PX3 is not connected to the network but you need to check the PX3 status, retrieve basic information, or even change network settings.

► Requirements for using PDView:

- The PX3 is running firmware version 3.0.0 or later.
- If you are using an Android device, it must support USB "On-The-Go" (OTG).
- An appropriate USB cable is required.
 - For Android, you need an USB OTG adapter cable.
 - For iOS, use the USB cable shipped with your iOS mobile device.

► To install PDView:

1. Use your mobile device to download the PDView app from the Google Play or Apple's App Store.

2. After installing the PDView, launch it. Below illustrates the PDView screen for Android devices.

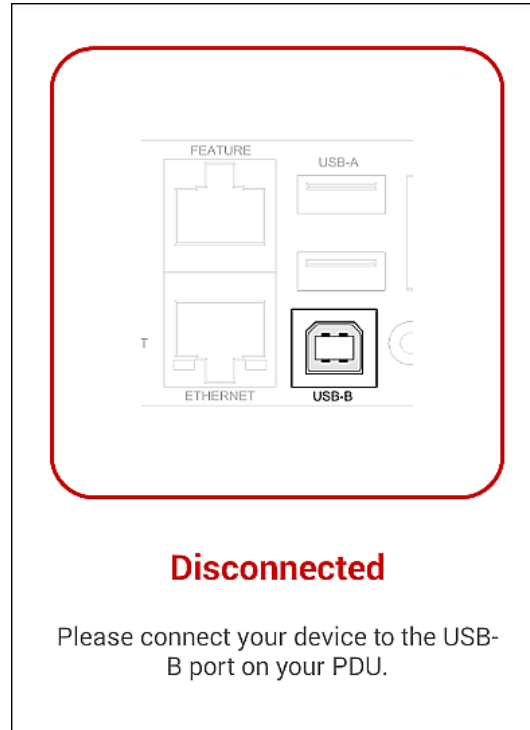

3. Connect your mobile device to the USB port of the PX3.
Your mobile device type determines which USB port on the PX3 shall be used to connect the mobile device. The PDView will automatically detect and indicate the appropriate USB port for connecting your mobile device.

The PDView shows a "Connected" message when it detects the physical connection to the PX3.

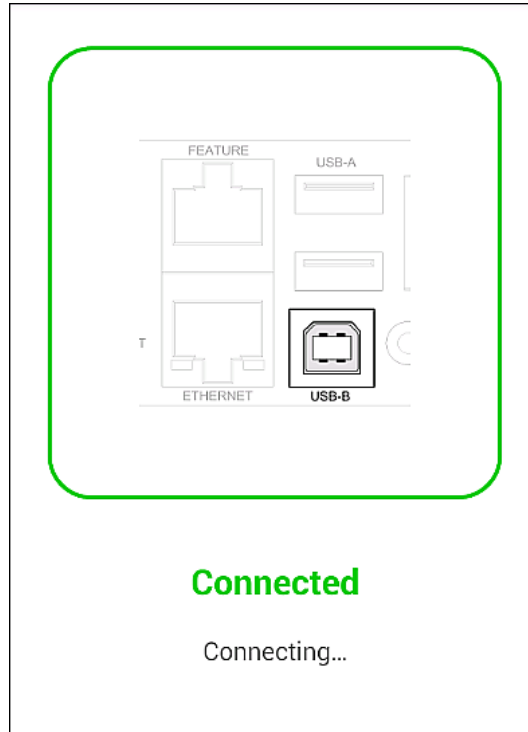

4. Log in to the PDView app at the login prompt. Now you can view limited PX3 information or even change some settings.

Tip: To skip the final login step, you can click the upper right icon of PDView to save one or multiple user credentials. Next time the app automatically logs in when it detects the PX3.

Altitude Correction Factors

If a Raritan differential air pressure sensor is attached to your device, the altitude you enter for the device can serve as an altitude correction factor. That is, the reading of the differential air pressure sensor will be multiplied by the correction factor to get a correct reading.

This table shows the relationship between different altitudes and correction factors.

Altitude (meters)	Altitude (feet)	Correction factor
0	0	0.95
250	820	0.98

Altitude (meters)	Altitude (feet)	Correction factor
425	1394	1.00
500	1640	1.01
740	2428	1.04
1500	4921	1.15
2250	7382	1.26
3000	9842	1.38

Unbalanced Current Calculation

Unbalanced current information is available on 3-phase models only. This section explains how the PX3 calculates the unbalanced current percentage.

► Calculation:

1. Calculate the average current of all 3 lines.

$$\text{Average current} = (L1+L2+L3) / 3$$

2. Calculate each line's current unbalance by having each line current subtracted and divided with the average current.

$$L1 \text{ current unbalance} = (L1 - \text{average current}) / \text{average current}$$

$$L2 \text{ current unbalance} = (L2 - \text{average current}) / \text{average current}$$

$$L3 \text{ current unbalance} = (L3 - \text{average current}) / \text{average current}$$

3. Determine the maximum absolute value among three lines' current unbalance values.

$$\text{Maximum} (|L1 \text{ current unbalance}| , |L2 \text{ current unbalance}| , |L3 \text{ current unbalance}|)$$

4. Convert the maximum value to a percentage.

$$\text{Unbalanced load percent} = 100 * \text{maximum current unbalance}$$

► Example:

- Each line's current:

$$L1 = 5.5 \text{ amps}$$

L2 = 5.2 amps

L3 = 4.0 amps

- Average current: $(5.5+5.2+4.0) / 3 = 4.9$ amps
- L1 current unbalance: $(5.5 - 4.9) / 4.9 = 0.1224$
- L2 current unbalance: $(5.2 - 4.9) / 4.9 = 0.0612$
- L3 current unbalance: $(4.0 - 4.9) / 4.9 = -0.1837$
- Maximum current unbalance:
Maximum $(|0.1224|, |0.0612|, |-0.1837|) = 0.1837$
- Current unbalance converted to a percentage:
 $100 * (0.1837) = 18\%$

Data for BTU Calculation

The heat generated by the PX3 device differs according to the model you purchased. To calculate the heat (BTU/hr), use the following power data according to your model type in the BTU calculation formula.

Model name	Maximum power (Watt)
PX2-1000 PX3-1000	5
PX2-2000 PX3-2000	20
PX2-3000 PX3-3000	24
PX2-4000 PX3-4000	24
PX2-5000 PX3-5000	24

Ways to Probe Existing User Profiles

This section indicates available ways to query existing user accounts on the PX3.

- With SNMP v3 activated, you get the "user unknown" error when the user name used to authenticate does not exist.
- Any user with the permission to view event rules can query all local existing users via JSON RPC.
- Any user with the permission to view the event log may get information about existing users from the log entries.
- Any authenticated users can query currently-existing connection sessions, including Webcam-Live-Preview sessions, which show a list of associated user names.

Raritan Training Website

Raritan offers free training materials for various Raritan products on the **Raritan training website** <http://www.raritantraining.com>. The Raritan products introduced on this website include the intelligent PDU, dcTrack®, Power IQ, KVM, EMX, BCM and CommandCenter Secure Gateway (CC-SG). Raritan would update the training materials irregularly according to the latest development of Raritan products.

To get access to these training materials or courses, you need to apply for a username and password through the Raritan training website. After you are verified, you can access the Raritan training website anytime.

Having access to the training website could be helpful for learning or getting some ideas regarding Raritan products and making correct decisions on purchasing them. For example, you can take the dcTrack video training before implementing or using it.

Role of a DNS Server

As Internet communications are carried out on the basis of IP addresses, appropriate DNS server settings are required for mapping domain names (host names) to corresponding IP addresses, or the PX3 may fail to connect to the given host.

Therefore, DNS server settings are important for external authentication. With appropriate DNS settings, the PX3 can resolve the external authentication server's name to an IP address for establishing a connection. If the *SSL/TLS encryption* is enabled, the DNS server settings become critical since only fully qualified domain name can be used for specifying the LDAP server.

For information on external authentication, see *Setting Up External Authentication* (on page 257).

Cascading Troubleshooting

Any accessibility problem occurred on one of the devices in the cascading chain may result in failure to access all downstream slave devices that are connected to it.

Possible Root Causes

The following lists the network accessibility issues and possible root causes.

You can always troubleshoot the software settings by connecting the PX3 to a computer if network access to that PX3 fails. See *Connecting the PX3 to a Computer* (on page 28).

Symptom	Probable cause
<p>Failure to access the master device</p>	<ul style="list-style-type: none"> • Network connection to the master device is lost. • No power is supplied to the master device. • The Ethernet or wireless interface on the master device is disabled. • IPv4 (or IPv6) settings are disabled on the master device. • In the port forwarding mode, the master device's role is incorrectly set to 'Slave'. • In the port forwarding mode, the interface where the network is connected is incorrectly selected as the downstream interface. • For the wireless networking, one of the following may lead to the accessibility failure: <ul style="list-style-type: none"> ▪ The USB wireless LAN adapter attached to the master device is not the Raritan USB WIFI LAN adapter. See <i>USB Wireless LAN Adapters</i> (on page 25). ▪ The wireless LAN configuration is not supported. See <i>Supported Wireless LAN Configuration</i> (on page 26). ▪ The installed CA certificate chain contains any certificate that has expired or is not valid yet.

Symptom	Probable cause
Failure to access a slave device	<ul style="list-style-type: none"> • Network connection to the master device is lost. • The cascading cable connected to the slave device in question or any upstream device (if available) is loose or lost. • No power is supplied to the slave device in question or any upstream devices. • The Ethernet or wireless interface on the master device is disabled. • IPv4 (or IPv6) settings are disabled on the slave device in question. • The cascading mode of the slave device in question or any upstream device is set incorrectly. For example, the master device is set to Bridging, but one of the slave devices is set to Port Forwarding. • In the port forwarding mode, the master device's role is incorrectly set to 'Slave'. • In the port forwarding mode, the master device's downstream interface is incorrectly set. For example, you use a USB cable to connect the 1st slave device, but select the Ethernet port as the downstream interface. • In the port forwarding mode, the role of the slave device in question or any upstream device is set to 'Master' instead of 'Slave'. • In the port forwarding mode, the port number you added to the IP address is incorrect. See <i>Port Number Syntax</i> (on page 234). • The firmware version of the slave device in question or any upstream device is older than 3.3.10.

*Tip: To determine which PX3 may be the failure point of network, you may ping each PX3 in the cascading chain, or check the slave-related events in the event log of each PX3. See **Slave Connection and Disconnection Events** (on page 691).*

- ▶ **For a PX3-iX7 cascading chain, also check the following:**
 - Whether the Ethernet interface (ETH1 or ETH2) where the network or cascading cable is connected is disabled on the slave device in question or any upstream device.
 - Whether the connection complies with the cascading guidelines if it is set to the port forwarding mode. See *Unsupported Cascading Connections for Port Forwarding* (on page 45).

Slave Connection and Disconnection Events

The log messages for connection/disconnection of a cascaded device are different for USB-cascading and Ethernet-cascading chains.

► **Messages for the Ethernet-cascading chain:**

Whenever the connection or disconnection of a master/slave device is detected, both PX3 devices connected via that network cable record this event in their internal logs.

There are two slave-related events:

Event	Description
The ETH1/2 network interface link is now up.	This log entry is generated when an iX7™ detects the connection of the upstream or downstream cascaded device on one of its Ethernet ports.
The ETH1/2 network interface link is now down.	This log entry is generated when an iX7™ detects the disconnection of the upstream or downstream cascaded device on one of its Ethernet ports.

► **Messages for the USB-cascading chain:**

In the bridging mode, events regarding connection/disconnection of a downstream slave device via USB is NOT logged.

However, in the port forwarding mode, whenever the connection or disconnection of a downstream slave device via USB is detected, the PX3 at the USB-A end of the USB cable logs it in the internal log. Note that the PX3 at the USB-B end of the cable does NOT log these events.

There are two slave-related events:

Event	Description
Slave connected	This log entry is generated when a PX3 detects the presence of a slave device on its USB-A port.
Slave disconnected	This log entry is generated when it detects the disconnection of a slave device from its USB-A port.

The Ping Tool

The PX3 provides a ping tool in the web interface and CLI so you can ping any host or PX3 in your data center.

Ping via the Web Interface

To log in to the web interface, see *HTTP/HTTPS Access* (see "Login" on page 127).

The Ping tool is useful for checking whether a host is accessible through the network or Internet.

► To ping a host:

1. Choose Maintenance > Network Diagnostics.
2. Type values in the following fields.

Field	Description
Network Host	The name or IP address of the host that you want to check.
Number of Requests	A number up to 20. This determines how many packets are sent for pinging the host.

3. Click Run Ping to ping the host. The Ping results are then displayed.

Ping via the CLI

You can access the CLI interface by connecting a computer to the PX3 or using SSH/Telnet. See *SSH/Telnet Access* (see "*With SSH or Telnet*" on page 367) for details.

You must perform the ping command in the diagnostic mode. To enter the diagnostic mode, type the following command and press Enter.

```
#          diag
```

After the diag> or diag# prompt appears, you can perform the ping command.

This ping command sends the ICMP ECHO_REQUEST message to a network host for checking its network connectivity. If the output shows the host is responding properly, the network connectivity is good. If not, either the host is shut down or it is not being properly connected to the network.

```
diag>      ping <host>
```

Variables:

- <host> is the host name or IP address whose networking connectivity you want to check.

Options:

- You can include any or all of additional options listed below in the ping command.

Options	Description
count <number1>	Determines the number of messages to be sent. <number1> is an integer number between 1 and 100.
size <number2>	Determines the packet size. <number2> is an integer number in bytes between 1 and 65468.
timeout <number3>	Determines the waiting period before timeout. <number3> is an integer number in seconds ranging from 1 to 600.

The command looks like the following when it includes all options:









```
diag> ping <host> count <number1> size <number2> timeout <number3>
```

Browsing through the Online Help

The PX3 Online Help is accessible over the Internet.



To use online help, Active Content must be enabled in your browser. If you are using Internet Explorer 7, you must enable Scriptlets. Consult your browser help for information on enabling these features.

► To use the PX3 online help:

1. Click Online Documentation. See *Web Interface Overview* (on page 129).
2. The online help opens in the default web browser.
3. To view the content of any topic, click the topic in the left pane. Then its content is displayed in the right pane.
4. To select a different topic, do any of the following:
 - To view the next topic, click the Next icon  in the toolbar.
 - To view the previous topic, click the Previous icon .
 - To view the first topic, click the Home icon .
5. To expand or collapse a topic that contains sub-topics, do the following:
 - To expand any topic, click the white arrow  prior to the topic, or double-click that topic. The arrow turns into a black, gradient arrow , and sub-topics appear below the topic.
 - To collapse any expanded topic, click the black, gradient arrow  prior to the topic, or double-click the expanded topic. The arrow then turns into a white arrow , and all sub-topics below that topic disappear.
6. To search for specific information, type the key word(s) or string(s) in the Search text box, and press Enter or click the Search icon  to start the search.
 - If necessary, select the "Match partial words" checkbox to include information matching part of the words entered in the Search text box.

The search results are displayed in the left pane.
7. To have the left pane show the list of topics, click the Contents tab at the bottom.
8. To show the Index page, click the Index tab.

Appendix K: Additional PX3 Information

9. To email any URL link to the currently selected topic to any person, click the "Email this page" icon  in the toolbar.
10. To email your comments or suggestions regarding the online help to Raritan, click the "Send feedback" icon .
11. To print the currently selected topic, click the "Print this page" icon .

Appendix L Integration

The PX3 device can work with certain Raritan products to provide diverse power solutions.

In This Chapter

Dominion KX II / III Configuration.....	696
Dominion KSX II, SX or SX II Configuration	701
Power IQ Configuration	706
dcTrack	707

Dominion KX II / III Configuration

Raritan PX2, PX3 or PX3TS series can be connected to the Raritan's Dominion KX II or KX III device (a digital KVM switch) to provide one more alternative of power management.

Note that this integration requires the following firmware versions:

- Dominion KX II -- 2.4 or later
- Dominion KX III -- ALL versions
- PX2 series -- 2.2 or later
- PX3 series -- 2.5.10 or later
- PX3TS series -- 2.6.1 or later

Dominion KX II or KX III integration requires D2CIM-PWR and straight CAT5 cable.

For more information on KX II / III, refer to:

- KX II or KX III User Guide on the **Support page** (<http://www.raritan.com/support/>)
- KX II or KX III Online Help on the **Product Online Help page** (<http://www.raritan.com/support/online-help/>)

Note: For documentation conveniences, both Dominion KX II and KX III products are referred to as "KX III" in the following sections.

Configuring Rack PDU Targets

KX III allows you to connect rack PDUs (power strips) to KX III ports. KX III rack PDU configuration is done from the KX III Port Configuration page.

Note: Raritan recommends no more than eight (8) rack PDUs (power strips) be connected to a KX III at once since performance may be affected.

Connecting a PX PDU

Raritan PX series rack PDUs (power strips) are connected to the Dominion device using the D2CIM-PWR CIM.

► **To connect the rack PDU:**

1. Connect the male RJ-45 of the D2CIM-PWR to the following female RJ-45 connector of the rack PDU.
 - PX1 series: RJ-45 "SERIAL" port
 - PX2 or PX3 series: RJ-45 "FEATURE" port
2. Connect the female RJ-45 connector of the D2CIM-PWR to any of the available female system port connectors on the KX III using a straight through Cat5 cable.
3. Attach an AC power cord to the target server and an available rack PDU outlet.
4. Connect the rack PDU to an AC power source.
5. Power on the device.

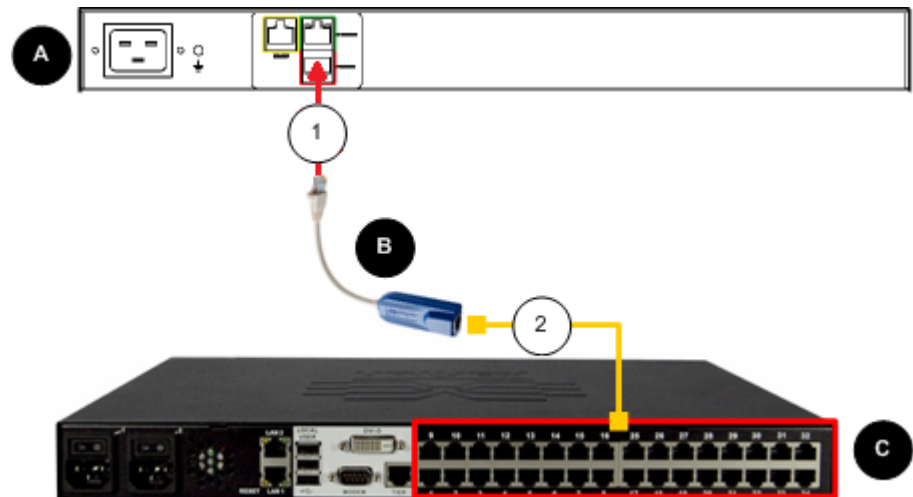







Diagram key	
	PX rack PDU
	D2CIM-PWR
	KX III
	D2CIM-PWR to rack PDU connection
	D2CIM-PWR to KX III target device port via Cat5 cable

Naming the Rack PDU (Port Page for Power Strips)

Note: PX rack PDUs (power strips) can be named in the PX as well as in the KX III.

Once a Raritan remote rack PDU is connected to the KX III, it will appear on the Port Configuration page. Click on the power port name on that page to access it. The Type and the Name fields are prepopulated.

Note: The (CIM) Type cannot be changed.

The following information is displayed for each outlet on the rack PDU: [Outlet] Number, Name, and Port Association.

Use this page to name the rack PDU and its outlets. Names can be up to 32 alphanumeric characters and can include special characters.

Note: When a rack PDU is associated with a target server (port), the outlet name is replaced by the target server name, even if you assigned another name to the outlet.

► To name the rack PDU and outlets:

Note: CommandCenter Secure Gateway does not recognize rack PDU names containing spaces.

1. Enter the Name of the rack PDU (if needed).
2. Change the [Outlet] Name if desired. (Outlet names default to the outlet #.)

3. Click OK.

Home > Device Settings > Port Configuration > Port

Port 17

Type:
PowerStrip

Name:

Outlets

Number	Name	Port Association
1	<input type="text" value="Dominion-Port1(1)"/>	Dominion- Port7
2	<input type="text" value="Outlet 2"/>	
3	<input type="text" value="Outlet 3"/>	
4	<input type="text" value="Outlet 4"/>	
5	<input type="text" value="Outlet 5"/>	
6	<input type="text" value="Outlet 6"/>	
7	<input type="text" value="Outlet 7"/>	
8	<input type="text" value="Outlet 8"/>	

Associating Outlets with Target Devices

The Port page opens when you click on a port on the Port Configuration page.

If an outlet is connected to the same server that the port is connected to, a power association can be made with the target device.

A server can have up to four power plugs and you can associate a different rack PDU (power strip) with each. From this page, you can define those associations so that you can power on, power off, and power cycle the server from the Port Access page.

To use this feature, you will need:

- Raritan remote rack PDU(s)
- Power CIMs (D2CIM-PWR)

Make a Power Association

► To make power associations (associate rack PDU outlets to KVM target servers):

Note: When a rack PDU is associated to a target server (port), the outlet name is replaced by the target server name (even if you assigned another name to the outlet).

1. On the Port Configuration page, select the target server you are associating the PDU with.
2. Choose the rack PDU from the Power Strip Name drop-down list.
3. For that rack PDU, choose the outlet from the Outlet Name drop-down list.
4. Repeat steps 1 and 2 for all desired power associations.
5. Click OK. A confirmation message is displayed.

Turning Outlets On/Off and Cycling Power

► To turn an outlet on:

1. Click the Power menu to access the Powerstrip page.
2. From the Powerstrip drop-down, select the PX rack PDU (power strip) you want to turn on.
3. Click Refresh to view the power controls.
4. Click On next to the outlet you want to power on.
5. Click OK to close the Power On confirmation dialog. The outlet will be turned on and its state will be displayed as 'on'.

► **To turn an outlet off:**

1. Click Off next to the outlet you want to power off.
2. Click OK on the Power Off dialog.
3. Click OK on the Power Off confirmation dialog. The outlet will be turned off and its state will be displayed as 'off'.

► **To cycle the power of an outlet:**

1. Click Cycle next to the outlet you want to cycle. The Power Cycle Port dialog opens.
2. Click OK. The outlet will then cycle (note that this may take a few seconds).
3. Once the cycling is complete the dialog will open. Click OK to close the dialog.

Dominion KSX II, SX or SX II Configuration

Raritan PX3 support the integration with Raritan's serial access products - Dominion KSX II, Dominion SX and Dominion SX II.

Cables used for connecting the PX3 to different Dominion access products are different.

- KSX II - a standard network patch cable (CAT5 or higher)
- SX - a CSCSPCS cable
- SX II - a CSCSPCS cable

Note: To only access the CLI of the PX3 via SX / SX II, treat the PX3 as a serial device by connecting SX / SX II to the PDU's serial port instead of the FEATURE port.

For more information on these Dominion serial access product, refer to:

- KSX II, SX or SX II User Guide on the **Support page** (<http://www.raritan.com/support/>)
- KSX II, SX or SX II Online Help on the **Product Online Help page** (<http://www.raritan.com/support/online-help/>)

Dominion KSX II

After connecting a Dominion KSX II to the Raritan PDU, you can monitor the PDU and even control its outlets if the PDU is an outlet-switching capable model.

Connecting a Rack PDU

► **To connect the Raritan PX to the KSX II:**

1. Connect one end of a Cat5 cable to the following ports of different Raritan PX.
 - PX1 series: RJ-45 "SERIAL" port
 - PX2 or PX3 series: RJ-45 "FEATURE" port
2. Connect the other end of the Cat5 cable to either the Power Ctrl. 1 or Power Ctrl. 2 ports on the back of the KSX II.
3. Attach an AC power cord to the target server and an available rack PDU outlet.
4. Connect the rack PDU to an AC power source.
5. Power on the KSX II device.

Important: When using CC-SG, the power ports should be inactive before attaching rack PDUs that were swapped between the power ports. If this is not done, there is a possibility that the number of power outlets will not be correctly detected, especially after swapping 8 and 20 outlet rack PDU models.

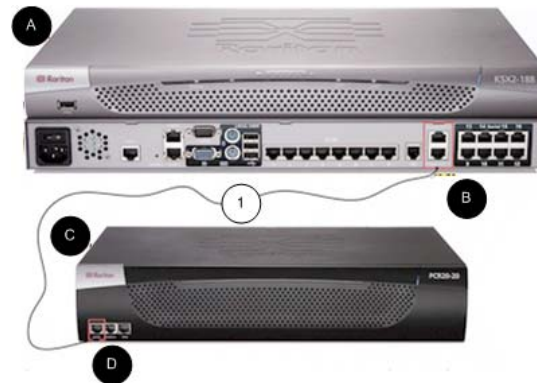

Diagram key			
A	KSX II	D	PX SERIAL or FEATURE port
B	KSX II Power Ctrl. 1 Port or Power Ctrl. 2 Port	1	Cat5 cable
C	PX		

Power Control

The KSX II operation to turn on/off or power cycle a PX is the same as the KX III operation. See *Turning Outlets On/Off and Cycling Power* (on page 700).

Dominion SX and SX II

By connecting to a Dominion SX or SX II device, you can associate one or more outlets on a PX3 device to specific SX or SX II ports.

Dominion SX II

The way to use Dominion SX II to configure and control a Raritan PDU is similar to using Dominion KX III, but the connection method is different from KX III.

Note: If using a CSCSPCS-1 cable for the connection, it must be "Rev.0C". If using a CSCSPCS-10 cable, it must be "Rev.0D".

Note that the appliances used in the diagram may not match your specific models. However, the connections and ports used are the same across models.

► **To connect the SX II to the Feature port on the PX:**

1. Connect the gray end of the CSCSPCS crossover Cat5 cable into the Feature port on the PX.
2. Connect the yellow end of the CSCSPCS crossover Cat5 cable into a port on the SX II.
3. Power on the PX (if it is not already).

4. You can now add the PX as a managed power strip to the SX II. See [Configure Power Strips from the Remote Console](#) or [Configure Power Strips Using CLI in the SX II User Guide or Online Help](#).

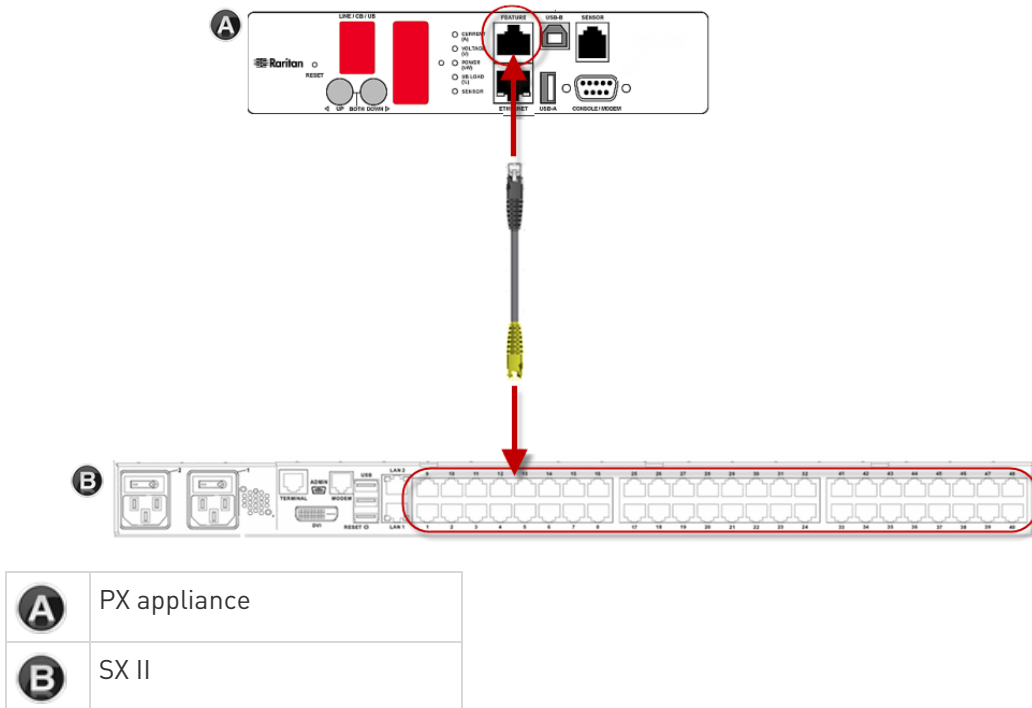

Dominion SX

Configuring a PX3 on Dominion SX

1. Choose Setup > Power Strip Configuration.
2. Click Add. The Power Strip Configuration screen appears.

Name:

Description:

Number of Outlets:
8

Port:

3. Type a name and description in the Name and Description fields.
4. Select the number of outlets from the Number of Outlets drop-down menu.
5. Type the port number in the Port field.
6. Click OK.

Power Control

1. Choose Power Control > Power Strip Power Control. The Outlet Control screen appears.

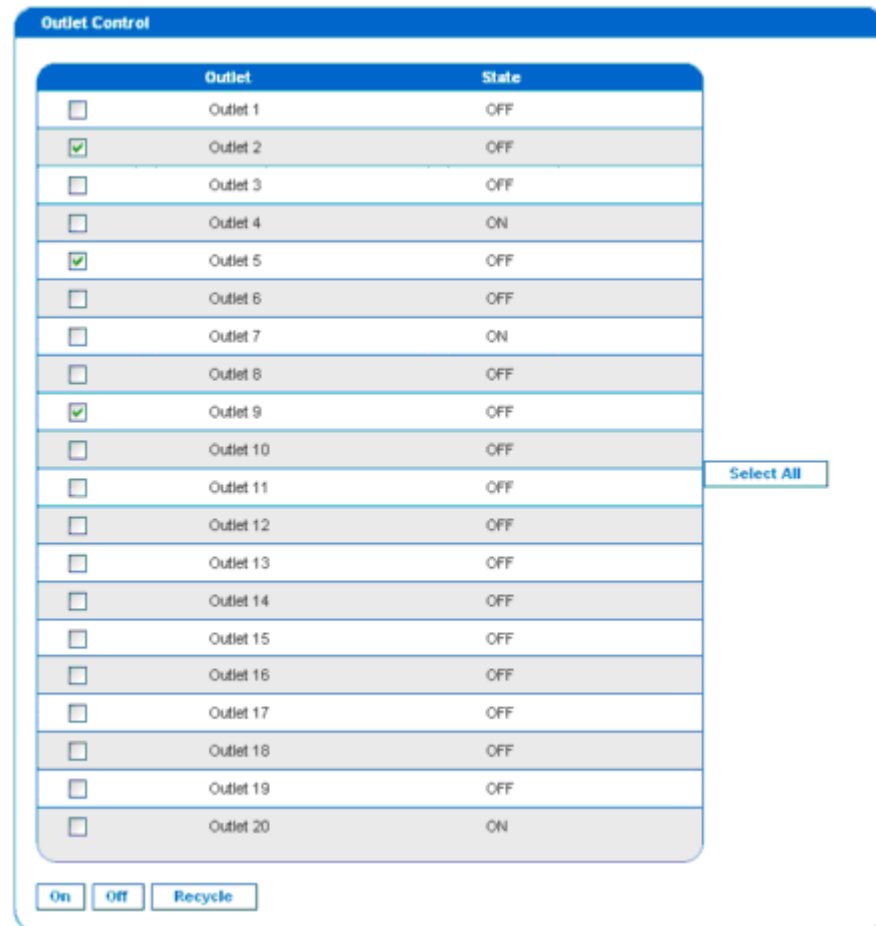

2. Check the box of outlet number you wish to control, and click On/Off buttons to power on/off the selected outlet(s).
3. A confirmation message appears, indicating successful operation.

Outlet 19: The power operation has been sent.

The system shall reflect successful operations shortly.

Checking Power Strip Status

1. Choose Power Control > Power Strip Status.

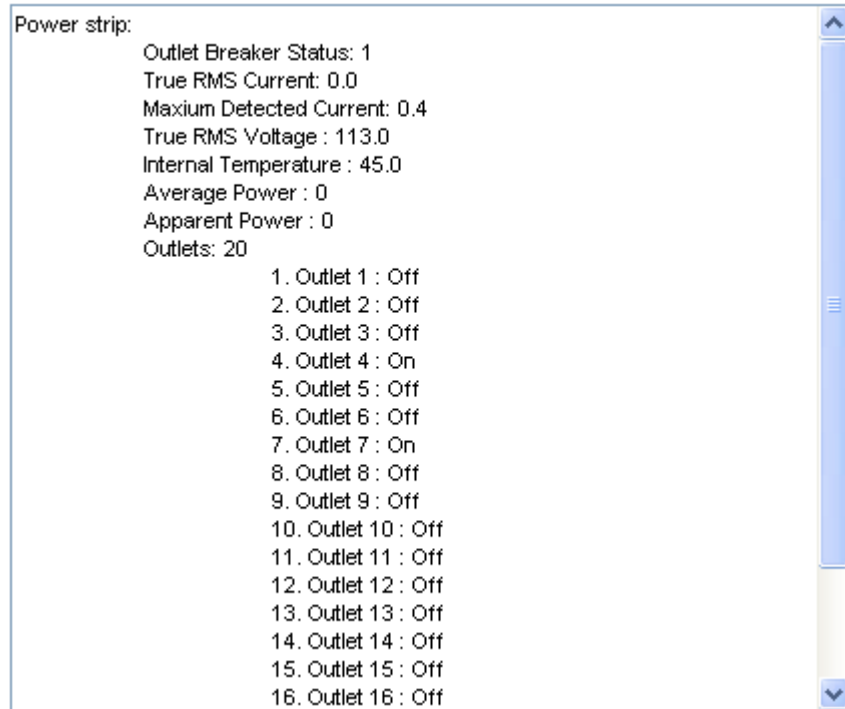
DPX Status:

2. A status box appears, displaying details of the controlled PX3, including power state of each outlet on the device.

Power IQ Configuration

Sunbird's Power IQ is a software application that collects and manages the data from different PDUs installed in your server room or data center. With this software, you can:

- Do bulk configuration for multiple PDUs
- Name outlets on different PDUs
- Switch on/off outlets on outlet-switching capable PDUs

For more information on Power IQ, refer to the Power IQ online help on the Sunbird website: <http://support.sunbirdcim.com>.

dcTrack

Sunbird's dcTrack® is a product that allows you to manage the data center. The PX3 is categorized as a power item in dcTrack. dcTrack offers an import wizard for conveniently adding the PX3 as well as other IT equipment to dcTrack for management.

You can use dcTrack to:

- Record and manage the data center infrastructure and assets
- Monitor the electrical consumption of the data center
- Track environmental factors in the data center, such as temperature and humidity
- Optimize the data center growth

For more information on dcTrack, refer to the online help accessible from the dcTrack application, or user documentation available on the Sunbird's website: <http://support.sunbirdcim.com>.

dcTrack Overview

dcTrack® is a powerful and intelligent data center management and automation application.

It has been designed by data center and IT professionals to provide broad and deep visibility into the data center. It empowers data center managers to plan for growth and change by optimizing their current operations, assets, and infrastructure.

With dcTrack, you can view everything in the data center from servers, blades, virtual servers and applications to data networks, IP addressing space and cabling. dcTrack also allows you to track real-time power consumption and manage raised floor space and rack elevations.

Use dcTrack to build your floor map data center map directly in the application, or import an existing floor map into the dcTrack. Further, dcTrack allows you to import AutoCAD® 2012 (and earlier) objects to build a data center map.

If you currently maintain data center information in spreadsheet format, that data can be imported into dcTrack using the Import wizard.

Isolate potential problems with end-to-end power and data circuits by visually tracing them. This allows you to identify all intermediate circuit points and locate problems.

By using dcTrack's workflow and change management feature, data center managers are better able to enforce best practices across the enterprise and meet ITIL framework guidelines. You can also opt to skip the Change Control workflow process and work in Request Bypass so requests are processed immediately.

dcTrack® can be used as a standalone product or integrated with Power IQ® for power and environmental monitoring.

Asset Management Strips and dcTrack

If any asset strips are connected to the PX3, the PX3 can transmit their information to Sunbird's dcTrack. All you have to do is to add the PX3 to dcTrack, and also add each IT item where an asset tag is attached to dcTrack.

*Note: For instructions on connecting asset strips, see **Connecting Asset Management Strips** (on page 72).*

If SNMP is enabled, event information can be transmitted to dcTrack. Specifically, Sunbird's Power IQ detects when an asset tag is connected or disconnected from an asset strip. Power IQ then generates a connection or disconnection event. When dcTrack polls Power IQ, the connection/disconnection events are pulled into dcTrack, and displayed in the dcTrack Web Client.

► **To poll and display asset management events in dcTrack**

- The PX3 that the asset strip is connected to must exist in dcTrack. EMX devices are identified as probes in dcTrack; Raritan PDUs are identified as sensors.
- Each IT item connected to the asset strip via an asset tag must exist in dcTrack.

You do not need to manually enter the asset tag IDs for IT items that already exist in dcTrack as long as these items are in the Installed status.

Simply, plug the item's asset tag into an asset strip that is connected to the PX3 that exists in dcTrack. dcTrack automatically assigns the asset tag ID to the existing IT item.

Note: If needed, the asset tag number can be overwritten.

For more information on dcTrack as well as how asset strips work with dcTrack, contact Sunbird Professional Services and Support from the <http://support.sunbirdcim.com>.

Index

+

+12V Power Supply Sensor (for iX7™ Only) •
xix, 48, 100, 145, 154

1

1U and 2U Port Locations • 89

1U Products • 2

2

2U Products • 2

A

A Note about Enabling Thresholds • 364

A Note about Firmware Upgrade Time • 343

A Note about Infinite Loop • 316

A Note about Untriggered Rules • 317

About the Interface • 365

Action Group • xx, 290, 292

Actuator Configuration Commands • 487, 488,
505

Actuator Control Operations • 527

Actuator Information • 382

Adding a Firewall Rule • 446

Adding a Monitored Device • 506

Adding a Role-Based Access Control Rule •
459

Adding Attributes to the Class • 630

Adding LDAP/LDAPS Servers • xx, 258, 260,
265

Adding Radius Servers • 258, 263, 265, 635

Adding, Removing or Swapping Cascaded
Devices • 238

Additional PX3 Information • 671

AD-Related Configuration • 636, 654, 667

Alarm • xx, 289, 291

Alerts • 97, 98

Alerts Notice in a Yellow or Red Screen • 93,
116

All Privileges • 476, 482, 486

Altitude Correction Factors • 147, 411, 685

APIPA and Link-Local Addressing • 3, 29, 127,
231, 246

Applicable Models • xvii, xix

Assertion Timeout Example for Temperature
Sensors • 680

Asset Management Commands • 512

Asset Management Strips and dcTrack • 710

Asset Strip • xx, 108, 110, 194, 195

Asset Strip Automatic Firmware Upgrade •
203

Asset Strip Information • 616

Asset Strip Management • 512

Asset Strip Settings • 394

Assets • 97, 107

Associating Outlets with Target Devices • 701

Automatic and Manual Modes • 93, 97, 324

Automatically Completing a Command • 534

Available Actions • xx, 82, 241, 272, 289, 292,
298, 306, 312, 352, 358

Available Data of the Outlets Overview Page •
159, 162, 164, 165

B

Backup and Restore of Device Settings • xxi,
333, 344, 347, 554

Backup and Restore via SCP • 348, 538

Beeper • 123, 149

Before You Begin • 4

Blade Extension Strip Settings • 396

Browsing through the Online Help • 131, 695

Built-in Rules and Rule Configuration • xx, 272,
273, 312

Bulk Configuration • xxi, 37, 333, 344, 347, 537,
554

Bulk Configuration Methods • 28, 37

Bulk Configuration or Firmware Upgrade via
DHCP/TFTP • 37, 342, 345, 549, 563

Bulk Configuration Restrictions • 344, 345

Bulk Configuration via SCP • 345, 537

Bulk Configuration/Upgrade Procedure • 563,
565

Button-Type Locking Outlets • 22

C

Calendar • 270

- Canceling the Power-On Process • 527
- Cascading Multiple PX3 Devices for Sharing
 - Ethernet Connectivity • xix, 27, 38, 220, 231, 335
- Cascading the PX3 via USB • xix, 24, 40, 43, 89, 90
- Cascading Troubleshooting • xxii, 39, 238, 689
- Change Load Shedding State • 289, 293
- Changing a User's Password • 469
- Changing an Outlet's Default State • 465
- Changing HTTP(S) Settings • 217, 239, 240, 247
- Changing Measurement Units • 476, 479
- Changing Modbus Settings • 217, 239, 245
- Changing SSH Settings • 209, 217, 239, 244
- Changing Telnet Settings • 217, 239, 244, 365
- Changing the Inlet Name • 467
- Changing the LAN Duplex Mode • xxii, 424
- Changing the LAN Interface Speed • xxi, 423
- Changing the Modbus Configuration • 437
- Changing the Modbus Port • 438
- Changing the Outlet Name • 465
- Changing the Overcurrent Protector Name • 468
- Changing the PDU Name • 405
- Changing the Role(s) • 476
- Changing the Sensor Description • 490
- Changing the Sensor Name • 488
- Changing the SSH Configuration • 434
- Changing the SSH Port • 434
- Changing the Telnet Configuration • 433
- Changing the Telnet Port • 434
- Changing the UDP Port • 511
- Changing Your Own Password • 478
- Changing Your Password • 128, 207, 209
- Checking Lua Scripts States • xxi, 329, 330, 331
- Checking Power Strip Status • 707
- Checking RCM State and Current • 592, 593
- Checking RCM States and Current • 596
- Checking the Accessibility of NTP Servers • 444
- Checking the Branch Circuit Rating • 4
- Circuit Breaker Orientation Limitation • 6, 7, 9, 10, 12, 13
- Circuit Breakers • 118
- Clearing Event Log • 403
- Clearing Information • 403
- Clearing WLAN Log • 404
- CLI Operations for RCM • 599
- Closing a Local Connection • 369
- Combining Regular Asset Strips • 72
- Command History • 400
- Commands for Environmental Sensors • 501
- Commands for Inlet Pole Sensors • 498
- Commands for Inlet Sensors • 496
- Commands for Outlet Sensors • 494
- Commands for Overcurrent Protector Sensors • 500
- Common Network Settings • xx, 218, 220
- Compliance with IEC 62020 • 591, 599, 600
- config.txt • 551, 553, 556
- Configuration Files • 549, 551, 563
- Configuration or Firmware Upgrade with a USB Drive • 38, 345, 549, 560, 563
- Configuring a Multi-Inlet Model • 155, 157
- Configuring a PX3 on Dominion SX • 705
- Configuring Data Push Settings • xx, 217, 294, 318
- Configuring DNS Parameters • xxi, 422
- Configuring Environmental Sensors' Default Thresholds • 492
- Configuring IPv4 Parameters • xxi, 413
- Configuring IPv6 Parameters • 417
- Configuring Login Settings • 217, 247, 266, 354
- Configuring Network Services • 239, 367
- Configuring Network Settings • xx, 3, 32, 217, 218, 226
- Configuring NTP Server Settings • 363
- Configuring Password Policy • 217, 247, 267
- Configuring Rack PDU Targets • 698
- Configuring Security Settings • 247
- Configuring SMTP Settings • xx, 217, 239, 242, 297, 300
- Configuring SNMP Settings • 209, 217, 239, 241, 289, 357
- Configuring the Cascading Mode • xxii, 430
- Configuring the PX3 • 27
- Configuring the PX3 Device and Network • 404
- Configuring the Serial Port • xxi, 82, 83, 217, 325, 368

- Configuring Webcams and Viewing Live Images • 81, 352, 355
 - Connecting a DPX2 Sensor Package to DPX3 • 62, 71
 - Connecting a DPX2 Sensor Package to DX • 61, 64, 65, 71
 - Connecting a GSM Modem • xix, 82, 299
 - Connecting a Locking Line Cord • 16, 86
 - Connecting a Logitech Webcam • xix, 81, 352
 - Connecting a PX PDU • 698
 - Connecting a Rack PDU • 703
 - Connecting a Schroff LHX/SHX Heat Exchanger • 84, 204
 - Connecting an Analog Modem • xix, 83, 368
 - Connecting an External Beeper • 83, 203
 - Connecting Asset Management Strips • 72, 195, 318, 710
 - Connecting Blade Extension Strips • 76
 - Connecting Composite Asset Strips • 79
 - Connecting Environmental Sensor Packages • 52, 53, 175
 - Connecting External Equipment (Optional) • 53, 89
 - Connecting Regular Asset Strips to PX3 • 74, 79
 - Connecting the PDU to a Power Source • 23
 - Connecting the PX3 to a Computer • xix, 3, 28, 231, 586, 587, 689
 - Connecting the PX3 to Your Network • 24, 27, 218
 - Connection Port Functions • xix, 27, 89
 - Connection Ports • 88
 - Control Buttons • 94, 605
 - Creating a CSR • 252, 253, 254
 - Creating a New Attribute • 629
 - Creating a Role • 482
 - Creating a Self-Signed Certificate • 252, 255
 - Creating a User Profile • 469
 - Creating Configuration Files via Mass Deployment Utility • 551, 559, 560
 - Creating IP Access Control Rules • 217, 247, 249
 - Creating Role Access Control Rules • 217, 247, 250, 251
 - Creating Roles • xx, 128, 207, 211, 213, 635
 - Creating Users • xx, 126, 128, 207, 208, 212, 213, 214, 216, 244, 258, 357
 - Customizing the Date and Time • 442
- ## D
- Daisy-Chain Limitations of Composite Asset Strips • 80
 - Dashboard • 132, 135, 155, 172, 291
 - Dashboard - Alarms • 136, 143, 289
 - Dashboard - Alerted Sensors • 98, 136, 140
 - Dashboard - Inlet History • 136, 142, 156
 - Dashboard - Inlet I1 • 136, 137, 155
 - Dashboard - OCP • xix, 136, 139
 - Data Encryption in 'config.txt' • 556, 560
 - Data for BTU Calculation • 687
 - Date and Time Settings • 379
 - dcTrack • 708
 - dcTrack Overview • 709
 - Deassertion Hysteresis Example for Temperature Sensors • 682
 - Default Log Messages • xx, 48, 268, 273, 278, 294, 297
 - Default Measurement Units • 379
 - Degaussing RCM Type B Sensors • 602
 - Deleting a Firewall Rule • 449
 - Deleting a Monitored Device • 507
 - Deleting a Role • 487
 - Deleting a Role-Based Access Control Rule • 461
 - Deleting a User Profile • 478
 - Deleting an NTP Server • xxii, 441
 - Detailed Information on Outlet Pages • 166, 168
 - Determining the SSH Authentication Method • 435
 - Determining the Time Setup Method • 440, 442
 - Device Configuration/Upgrade Procedure • 549
 - Device Info • xix, 3, 27, 28, 97, 111, 231
 - Device Information • xxi, 333, 334
 - Device Settings • xx, 133, 217
 - devices.csv • 551, 553, 557, 558
 - Device-Specific Settings NOT Included • 344, 346
 - DHCP IPv4 Configuration in Linux • 564, 582

- DHCP IPv4 Configuration in Windows • 564, 565
 - DHCP IPv6 Configuration in Linux • 564, 584
 - DHCP IPv6 Configuration in Windows • 564, 575
 - Diagnostic Commands • 532
 - Different CLI Modes and Prompts • 367, 369, 371, 403, 404, 405, 444, 522, 524, 527, 532
 - Disabling or Enabling Front Panel RCM Self-Test • 325, 594, 597, 621
 - Disconnecting a Locking Line Cord • 17
 - Dominion KSX II • 702
 - Dominion KSX II, SX or SX II Configuration • 207, 702
 - Dominion KX II / III Configuration • 207, 697
 - Dominion SX • 705
 - Dominion SX and SX II • 704
 - Dominion SX II • xxii, 704
 - Dot-Matrix LCD Display • 91
 - Downloading Diagnostic Data via SCP • 539
 - Downloading Diagnostic Information • 333, 349
 - Downloading SNMP MIB • 242, 357, 360, 598
 - DPX Sensor Packages • 51, 53, 54
 - DPX2 Sensor Packages • 51, 53, 59
 - DPX3 Sensor Packages • 51, 53, 61
 - Dual Ethernet Connection (for iX7™ Only) • xix, 24, 27
 - DX Sensor Packages • 51, 53, 63, 304
- E**
- EAP CA Certificate Example • 427, 429
 - Editing or Deleting a Rule/Action • 289, 312, 324
 - Editing or Deleting IP Access Control Rules • xx, 249
 - Editing or Deleting Ping Monitoring Settings • 322
 - Editing or Deleting Role Access Control Rules • xx, 251
 - Editing or Deleting Roles • 214
 - Editing or Deleting Users • 128, 212, 214, 215
 - Editing rcusergroup Attributes for User Members • 632
 - Email and SMS Message Placeholders • xx, 296, 297, 299, 309
 - Enabling and Configuring SNMP • 313, 314, 317, 357
 - Enabling or Disabling a User Profile • 472
 - Enabling or Disabling an Inlet (for Multi-Inlet PDUs) • 467
 - Enabling or Disabling Data Logging • 410
 - Enabling or Disabling EnergyWise • 510
 - Enabling or Disabling Front Panel Actuator Control • 463
 - Enabling or Disabling Front Panel Outlet Switching • 462
 - Enabling or Disabling Load Shedding • 523
 - Enabling or Disabling Modbus • 437
 - Enabling or Disabling Peripheral Device Auto Management • 412
 - Enabling or Disabling Service Advertising • 438
 - Enabling or Disabling SNMP v1/v2c • 435
 - Enabling or Disabling SNMP v3 • 436
 - Enabling or Disabling SSH • 434
 - Enabling or Disabling Strong Passwords • 455
 - Enabling or Disabling Telnet • 433
 - Enabling or Disabling the LAN Interface • xxi, 423
 - Enabling or Disabling the Read-Only Mode • 438
 - Enabling or Disabling the Restricted Service Agreement • 450
 - Enabling Service Advertising • 217, 239, 246, 438
 - Enabling the Restricted Service Agreement • 127, 217, 247, 268
 - EnergyWise Configuration Commands • 510
 - EnergyWise Settings • 394
 - Entering Configuration Mode • 369, 404, 429, 470, 478, 600
 - Entering Diagnostic Mode • 369, 531
 - Environmental Sensor Configuration Commands • 487
 - Environmental Sensor Default Thresholds • 390
 - Environmental Sensor Information • 380, 614
 - Environmental Sensor Package Information • 381
 - Environmental Sensor Threshold Information • 389

- Equipment Setup Worksheet • 5, 545
 - Ethernet Interface Settings • xx, 27, 115, 219, 221
 - Event Log • 397
 - Event Rules and Actions • xx, 48, 83, 123, 143, 149, 155, 171, 188, 206, 217, 241, 242, 272, 291, 318, 320, 329
 - Example • 442, 451, 470, 478, 520, 523
 - Ping Monitoring and SNMP Notifications • 320, 322
 - Example - Actuator Naming • 506
 - Example - Creating a Role • 487
 - Example - Default Upper Thresholds for Temperature • 494
 - Example - Inlet Naming • 468
 - Example - OCP Naming • 468
 - Example - Outlet Naming • 466
 - Example - Ping Command • 534
 - Example - Power Cycling Specific Outlets • 527
 - Example - Server Settings Changed • 509
 - Example - Setting Up EnergyWise • 512
 - Example - Turning On a Specific Actuator • 529
 - Example 1 • 316
 - Example 1 - Asset Strip LED Colors for Disconnected Tags • 518
 - Example 1 - Basic Security Information • 401
 - Example 1 - Combination of IP, Subnet Mask and Gateway Parameters • 521
 - Example 1 - Creating a User Profile • 481
 - Example 1 - Environmental Sensor Naming • 492
 - Example 1 - IPv4 Firewall Control Configuration • 463
 - Example 1 - Networking Mode • 439
 - Example 1 - PDU Naming • 412
 - Example 1 - Time Setup Method • 443
 - Example 1 - Upper Critical Threshold for a Temperature Sensor • 503
 - Example 2 • 316
 - Example 2 - Adding an IPv4 Firewall Rule • 463
 - Example 2 - Combination of Upper Critical and Upper Warning Settings • 521
 - Example 2 - Enabling Both IP Protocols • 439
 - Example 2 - In-Depth Security Information • 402
 - Example 2 - Modifying a User's Roles • 481
 - Example 2 - Outlet Sequence • 412
 - Example 2 - Primary NTP Server • 443
 - Example 2 - Rack Unit Naming • 519
 - Example 2 - Sensor Threshold Selection • 492
 - Example 2 - Warning Thresholds for Inlet Sensors • 503
 - Example 3 • xx, 316
 - Example 3 - Basic PDU Information • 402
 - Example 3 - Combination of SSID and PSK Parameters • 522
 - Example 3 - Default Measurement Units • 481
 - Example 3 - Outlet Sequence Delay • 412
 - Example 3 - Upper Thresholds for Overcurrent Protector Sensors • 504
 - Example 3 - User Blocking • 464
 - Example 3 - Wireless Authentication Method • 439
 - Example 4 - Adding an IPv4 Role-based Access Control Rule • 464
 - Example 4 - Combination of Upper Critical, Upper Warning and Lower Warning Settings • 522
 - Example 4 - In-Depth PDU Information • 403
 - Example 4 - Non-Critical Outlets • 413
 - Example 4 - Static IPv4 Configuration • 439
 - Examples • 401, 412, 439, 443, 463, 480, 491, 503, 518
 - Existing Roles • 393
 - Existing User Profiles • 379, 392
 - Expansion RJ-45 Port Pinouts (for iX7™ Only) • 543
 - Extended Cascading with PX3-iX7 Models • xix, 42, 91
 - External Beeper • 194, 203, 290, 293
- ## F
- Feature Port • 133, 193, 195, 203, 205, 207
 - Feature RJ-45 Port Pinouts • 543
 - Filling Out the Equipment Setup Worksheet • 5
 - Finding the Sensor's Serial Number • 177, 184
 - Firewall Control • 444
 - Firmware Update via SCP • 342, 536

Firmware Upgrade via USB • 342, 550, 561
 Forcing a Password Change • 472
 Forcing the Device Detection Mode • 520
 FreeRADIUS Standard Attribute Illustration • 635, 653
 FreeRADIUS VSA Illustration • 654, 666
 From LDAP/LDAPS • 628
 From Microsoft Active Directory • 628
 Front Panel Operations for RCM • 97, 595, 619
 Front Panel Settings • 93, 179, 217, 324
 Full Disaster Recovery • xxi, 343
 Fuse • 120
 Fuse Replacement on 1U Models • 121
 Fuse Replacement on Zero U Models • 120
 fwupdate.cfg • 550, 551, 552, 556, 558, 561

G

Gathering LDAP/Radius Information • 258, 259

H

Help Command • 370
 History Buffer Length • 400
 How the Automatic Management Function Works • 147, 152, 412

I

Identifying Cascaded Devices • xxi, 334, 335
 Identifying the Sensor Position and Channel • 177, 185
 Idle Timeout • 453
 Individual OCP Pages • xix, 172
 Individual Outlet Pages • 146, 150, 151, 159, 161, 163, 165, 169
 Individual Sensor/Actuator Pages • 106, 140, 147, 152, 176, 178, 179, 188, 192
 Initial Installation and Configuration • 23
 Initial Network Configuration via CLI • xix, 28, 29, 30, 32, 586, 587
 Initialization Delay Use Cases • 146, 151
 Inlet • 86, 97, 101, 132, 137, 138, 148, 155, 157
 Inlet Configuration Commands • 466
 Inlet Information • 377, 607
 Inlet Pole Sensor Threshold Information • 386
 Inlet Sensor Threshold Information • 385

Inrush Current and Inrush Guard Delay • 147, 151
 Installing a CA-Signed Certificate • xx, 252, 254
 Installing Cable Retention Clips on Outlets (Optional) • 19
 Installing Cable Retention Clips on the Inlet (Optional) • 18
 Installing or Downloading Existing Certificate and Key • 252, 256
 Installing the USB-to-Serial Driver (Optional) • 29, 31
 Integration • 697
 Interface Names • xx, 227, 230
 Internal Beeper • 290, 294
 Internal Beeper State • 145, 149, 593
 Introduction • 1
 Introduction to Asset Tags • xix, 74
 Introduction to PDU Components • 85
 IP Configuration • xxi, 372, 373
 IPv4 Address • xxii, 610
 IPv4-Only or IPv6-Only Configuration • xxi, 372, 373

L

Layout • 362
 LCD Message for RCM Critical State • 595
 LDAP Configuration Illustration • 258, 622
 Load Shedding Configuration Commands • 522
 Load Shedding Mode • 160, 163, 164, 167, 293, 409
 Load Shedding Settings • 393
 Locking Outlets and Cords • 19, 20
 Log an Event Message • 290, 294
 Logging in to CLI • 366, 560, 587
 Logging out of CLI • 535
 Login • 28, 30, 127, 693
 Login Limitation • 452
 Login, Logout and Password Change • 126
 Logout • 129
 Lowercase Character Requirement • 455
 Lua Scripts • xxi, 217, 302, 327

M

MAC Address • 611
 Main Menu • 93, 96, 596, 597
 Maintenance • 133, 333
 Make a Power Association • 701
 Making a Power-Sharing Connection • xix, 49
 Managed vs Unmanaged Sensors/Actuators • 175, 180, 181
 Managing External Authentication Settings • xx, 258, 262, 264, 265
 Managing Firewall Rules • 446
 Managing One Sensor or Actuator • 177, 178, 186
 Managing Role-Based Access Control Rules • 458
 Manually Starting or Stopping a Script • xxi, 328, 329
 Maximum Ambient Operating Temperature • 4, 541
 Maximum Password History • 457
 Maximum Password Length • 455
 Menu • xix, 130, 132, 145, 155, 158, 170, 175, 194, 195, 203, 204, 207, 217, 329, 333, 352, 354, 355, 592
 Minimum Password Length • 455
 Miscellaneous • 84, 104, 194, 195, 204, 217, 296, 303, 332, 334, 361, 612
 Mixing Diverse Sensor Types • 66, 68
 Modifying a Firewall Rule • 448
 Modifying a Monitored Device's Settings • 507
 Modifying a Role • 485
 Modifying a Role-Based Access Control Rule • 460
 Modifying a User Profile • 469
 Modifying a User's Personal Data • 471
 Modifying Firewall Control Parameters • 445
 Modifying or Deleting a Script • xxi, 327, 331
 Modifying Role-Based Access Control Parameters • 457
 Modifying SNMPv3 Settings • 473
 Monitoring Server Accessibility • 217, 320, 322
 Mounting 1U or 2U Models • 14
 Mounting Zero U Models Using Button Mount • 9

Mounting Zero U Models Using Claw-Foot Brackets • 10
 Mounting Zero U Models Using L-Brackets • 7
 Mounting Zero U Models Using L-Brackets and Buttons • 13
 Mounting Zero U Models Using Two Rear Buttons • 12
 Multi-Command Syntax • 446, 452, 454, 458, 469, 471, 473, 476, 479, 492, 494, 496, 498, 500, 501, 505, 507, 521

N

Naming a Rack Unit • 516
 Naming an Asset Strip • 512
 Naming the Rack PDU (Port Page for Power Strips) • 699
 Network Configuration • xxi, 372
 Network Configuration Commands • 413
 Network Diagnostics • 333, 348
 Network Interface Settings • xxi, 374
 Network Service Settings • 375
 Network Troubleshooting • 348, 531
 NPS Standard Attribute Illustration • 635
 NPS VSA Illustration • 654
 Numeric Character Requirement • 456

O

OCPs • 97, 103, 133, 139, 170, 172, 174
 Old PX3 Character LCD Display • 92, 603
 Operating the Dot-Matrix LCD Display • 93, 95, 96, 98, 104, 118
 Operating the LCD Display • 605
 Options for Outlet State on Startup • 146, 150, 167
 Outlet Configuration Commands • 465
 Outlet Information • 376, 605
 Outlet Pole Sensor Threshold Information • 384
 Outlet Sensor Threshold Information • 383
 Outlet Switching • 612
 Outlets • xix, 87, 132, 158, 162, 164, 165, 304
 Overcurrent Protector Configuration Commands • 468
 Overcurrent Protector Information • 378, 608

Overcurrent Protector Sensor Threshold Information • 387
Overriding DHCP-Assigned NTP Servers • 441, 444
Overview of the Cascading Modes • xx, 231, 233
Overview of the LCD Display • 604, 605

P

Package Contents • 1, 4
Panel Components • 85
Password Aging • 453
Password Aging Interval • 453
PDU • xix, 97, 99, 123, 130, 132, 145, 150, 151, 152, 153, 155, 156, 161, 169, 175, 190, 192, 409
PDU Configuration • 149, 376
PDU Configuration Commands • 405
PDView App for Viewing the PX3 • 683
Peripherals • 63, 97, 104, 133, 152, 175, 181, 183, 186, 188, 189, 315, 325
Ping via the CLI • 694
Ping via the Web Interface • 693
Port Forwarding Examples • 128, 232, 235, 236
Port Number Syntax • 232, 234, 236, 691
Possible Root Causes • xxii, 689
Power CIM • 194, 207
Power Control • 704, 706
Power Control Operations • 524
Power Cycling the Outlet(s) • 526
Power IQ Configuration • 707
Power-Off Period Options for Individual Outlets • 167, 169
Power-Sharing Configurations and Restrictions • xix, 47, 49, 50
Power-Sharing Restrictions and Connection (for iX7™ Only) • xix, 47, 91, 155
Preparing the Installation Site • 4
Product Models • 1
Push Out Sensor Readings • 290, 294
PX3 Latching Relay Behavior • 146, 150, 406, 407, 408, 409
PX3 Models with Residual Current Monitoring • 149, 324, 589, 619
PX3-1000 Series • 87

PX3-2000 Series • 87

Q

Querying Available Parameters for a Command • 370, 371
Querying DNS Servers • 532
Quick Access to a Specific Page • 127, 134
Quitting Configuration Mode • 405, 451
Quitting Diagnostic Mode • 532

R

Rack Unit Configuration • 515
Rack Unit Settings of an Asset Strip • 395
Rackmount Safety Guidelines • 6
Rackmount, Inlet and Outlet Connections • 6
Rack-Mounting the PDU • 6
RADIUS Configuration Illustration • 258, 635
Raritan Training Website • 688
RCM Critical State Alarm • xxii, 593
RCM Current Sensor • 589
RCM Information • 595, 619
RCM Residual Current and State Objects • 599
RCM Self-Test • 592
RCM SNMP Operations • 598
RCM State Sensor • 590, 593
RCM Trap • 598
Rebooting the PX3 Device • xxi, 333, 350
Record Snapshots to Webcam Storage • 290, 295
Reliability Data • 400
Reliability Error Log • 400
Remembering User Names and Passwords • 129
Replaceable Controller • 85, 124
Request LHX/SHX Maximum Cooling • xx, 290, 296
Reserving IP Addresses in DHCP Servers • xxii, 672, 673, 674
Reserving IP in Linux • xxii, 674
Reserving IP in Windows • xxii, 673
Reset Button • 117
Resetting Active Energy Readings • 530
Resetting All Settings to Factory Defaults • xxi, 333, 350, 586

- Resetting the Button-Type Circuit Breaker • 118
 - Resetting the Handle-Type Circuit Breaker • 119
 - Resetting the PX3 • 529
 - Resetting to Factory Defaults • 117, 351, 531, 586
 - Restarting the PDU • 530
 - Restricted Service Agreement • 450
 - Retrieving Previous Commands • 534
 - Retrieving Software Packages Information • 333, 351
 - Returning User Group Information • 628
 - RJ45-to-DB9 Cable Requirements for Computer Connections (for iX7™ Only) • 2, 29, 30, 90, 672
 - RJ45-to-DB9 Cable Requirements for Modem Connections (for iX7™ Only) • 31, 82, 83, 671
 - Role Configuration Commands • 482
 - Role of a DNS Server • 624, 689
 - Role-Based Access Control • 457
 - Running RCM Self-Test • 596, 597, 599, 602
- ## S
- Safety Guidelines • ii
 - Safety Instructions • iii, 4
 - Sample Environmental-Sensor-Level Event Rule • 315
 - Sample Event Rules • 275, 313
 - Sample Inlet-Level Event Rule • 314
 - Sample Outlet-Level Event Rule • 313
 - Sample PDU-Level Event Rule • 313
 - Scheduling an Action • 273, 294, 306, 308, 594
 - Scheduling RCM Self-Test • 594
 - Schroff LHX/SHX • 194, 204
 - SecureLock™ Outlets and Cords • 21
 - Security Configuration Commands • 444
 - Security Settings • 391
 - Send an SNMP Notification • xx, 241, 290, 300
 - Send Email • 278, 290, 296, 308, 309
 - Send Sensor Report • xx, 216, 290, 297, 308
 - Send Sensor Report Example • 297, 308
 - Send SMS Message • 290, 299, 309
 - Send Snapshots via Email • 290, 300
 - Sending Snapshots or Videos in an Email or Instant Message • 352, 353, 354
 - Sensor RJ-45 Port Pinouts • 542
 - Sensor Threshold Configuration Commands • 494
 - Sensor Threshold Settings • 154, 157, 171, 173, 179, 180, 189, 363, 676
 - Sensor/Actuator Location Example • 152, 190, 192
 - Sensor/Actuator States • 99, 105, 141, 176, 177, 182
 - Serial Port Configuration Commands • 519
 - Serial Port Settings • 394
 - Serial RS-232 • 541, 542
 - Server Reachability Configuration Commands • 506
 - Server Reachability Information • 398
 - Server Reachability Information for a Specific Server • 399
 - Setting an LED Color for a Rack Unit • 517
 - Setting an LED Mode for a Rack Unit • 517, 518
 - Setting an Outlet's Cycling Power-Off Period • 466
 - Setting Data Logging • xx, 217, 317, 319, 410
 - Setting Data Logging Measurements Per Entry • 410
 - Setting Default Measurement Units • 147, 207, 215, 216, 476, 479
 - Setting EAP Parameters • 427
 - Setting Front Panel RCM Self-Test • 601
 - Setting IPv4 Static Routes • xxi, 416
 - Setting IPv6 Static Routes • xxi, 420
 - Setting LAN Interface Parameters • xxi, 422
 - Setting LED Colors for Connected Tags • 515, 516, 517
 - Setting LED Colors for Disconnected Tags • 515, 516, 517
 - Setting Network Service Parameters • 432
 - Setting Non-Critical Outlets • xix, 160, 163, 164
 - Setting NTP Parameters • 440, 444
 - Setting Outlet Power-On Sequence and Delay • 160, 162
 - Setting RCM Current Thresholds • xxii, 590, 593, 600
 - Setting RCM Thresholds • 599

- Setting the Alarmed to Normal Delay for DX-PIR • 491
- Setting the Authentication Method • 425
- Setting the Automatic Daylight Savings Time • 443
- Setting the Baud Rates • 519
- Setting the BSSID • 430
- Setting the Cascading Mode • xx, 3, 27, 39, 41, 44, 113, 218, 219, 220, 222, 231, 233, 238, 336
- Setting the Date and Time • 217, 269, 363
- Setting the History Buffer Length • 520
- Setting the HTTP Port • 432
- Setting the HTTPS Port • 433
- Setting the Inrush Guard Delay Time • 408
- Setting the IPv4 Address • xxi, 415
- Setting the IPv4 Configuration Mode • xxi, 413
- Setting the IPv4 Gateway • xxi, 416
- Setting the IPv4 Preferred Host Name • xxi, 414
- Setting the IPv6 Address • xxi, 419
- Setting the IPv6 Configuration Mode • xxi, 417
- Setting the IPv6 Gateway • xxi, 420
- Setting the IPv6 Preferred Host Name • xxi, 418
- Setting the LED Operation Mode • 516
- Setting the Outlet Initialization Delay • 409
- Setting the Outlet Power-On Sequence • 406
- Setting the Outlet Power-On Sequence Delay • 407
- Setting the Outlet Relay Behavior • 406
- Setting the PDU-Defined Cycling Power-Off Period • 408, 466
- Setting the PDU-Defined Default Outlet State • 407, 466
- Setting the Polling Interval • 511
- Setting the PSK • 426
- Setting the Registry to Permit Write Operations to the Schema • 629
- Setting the SNMP Configuration • 435
- Setting the SNMP Read Community • 436
- Setting the SNMP Write Community • 436
- Setting the SSID • 425
- Setting the sysContact Value • 436
- Setting the sysLocation Value • 437
- Setting the sysName Value • 437
- Setting the Time Zone • 363, 441
- Setting the X Coordinate • 489
- Setting the Y Coordinate • 489
- Setting the Z Coordinate • 411, 490
- Setting the Z Coordinate Format for Environmental Sensors • 411, 490, 506
- Setting Thresholds for Total Active Energy or Power • 148, 153
- Setting Up an SSL/TLS Certificate • xx, 217, 247, 252
- Setting Up External Authentication • 217, 247, 257, 689
- Setting Wireless Parameters • 425
- Setting Your Preferred Measurement Units • 147, 207, 211, 215, 216
- Showing Information • 371
- Showing Network Connections • 532
- Showing Residual Current Monitor Information • 600
- Showing the Firmware Upgrade Progress • 117, 342
- SHX Request Maximum Cooling • 206
- Single Login Limitation • 452
- Slave Connection and Disconnection Events • xxii, 691, 692
- SNMP Gets and Sets • 361
- SNMP Sets and Thresholds • 363
- SNMPv2c Notifications • 241, 358
- SNMPv3 Notifications • 241, 358, 359
- Sorting a List • 134, 140, 159, 170, 176, 197, 212, 214, 226, 309, 338, 340, 344
- Special Character Requirement • 456
- Specifications • 6, 541
- Specifying Non-Critical Outlets • 393, 409
- Specifying the Agreement Contents • 451
- Specifying the Asset Strip Orientation • 514
- Specifying the CC Sensor Type • 488
- Specifying the Device Altitude • 411
- Specifying the EnergyWise Domain • 510
- Specifying the EnergyWise Secret • 511
- Specifying the Number of Rack Units • 513
- Specifying the Primary NTP Server • 440
- Specifying the Rack Unit Numbering Mode • 513
- Specifying the Rack Unit Numbering Offset • 514

- Specifying the Secondary NTP Server • 440
- Specifying the SSH Public Key • 435, 477
- Standard Attributes • 635
- Start or Stop a Lua Script • xx, 291, 302, 328, 329
- Static Route Examples • xx, 218, 221, 227, 416, 420
- Step A
 - Add Your PX3 as a RADIUS Client • 635, 636, 654, 655
- Step A. Determine User Accounts and Roles • 622
- Step B
 - Configure Connection Policies and Standard Attributes • 636, 640
 - Configure Connection Policies and Vendor-Specific Attributes • 654, 659
- Step B. Configure User Groups on the AD Server • 623
- Step C. Configure LDAP Authentication on the PX3 Device • xxii, 624
- Step D. Configure Roles on the PX3 Device • 625
- Strong Passwords • 454
- Supported Maximum DPX Sensor Distances • 54, 58
- Supported Sensor Configurations for Power Sharing • xix, 50, 51
- Supported Web Browsers • 126
- Supported Wireless LAN Configuration • 26, 690
- Switch LHX/SHX • 291, 303
- Switch Outlets • 291, 303
- Switch Peripheral Actuator • 291, 304
- Switching Off an Actuator • 528
- Switching On an Actuator • 528
- Syslog Message • 291, 305
- System and USB Requirements • 549, 550

T

- Testing the Network Connectivity • 533
- TFTP Requirements • 564
- The Ping Tool • 693
- The PX3 MIB • 361
- Thresholds and Sensor States • 676
- Time Configuration Commands • 439

- Time Units • 145, 153, 169, 266, 267
- Tracing the Route • 534
- Turning Off the Outlet(s) • 525
- Turning On the Outlet(s) • 524
- Turning Outlets On/Off and Cycling Power • 701, 704

U

- Unbalanced Current Calculation • 686
- Unblocking a User • 267, 529
- Unpacking the Product and Components • 4
- Unsupported Cascading Connections for Port Forwarding • xix, 42, 45, 691
- Updating the LDAP Schema • 628
- Updating the PX3 Firmware • xxi, 333, 341, 536
- Updating the Schema Cache • 632
- Upgrade Guidelines for Existing
 - USB-Cascading Chains • xxi, 341, 342
- Uppercase Character Requirement • 456
- USB Wireless LAN Adapters • xix, 25, 26, 41, 44, 690
- USB-Cascaded Device's Position • xxii, 618
- User Blocking • 454
- User Configuration Commands • 468
- User Interfaces Showing Default Units • xx, 216
- User Management • 133, 207
- Using an Optional DPX3-ENVHUB4 Sensor Hub • 55, 66
- Using an Optional DPX-ENVHUB2 cable • 56
- Using an Optional DPX-ENVHUB4 Sensor Hub • 55
- Using Default Thresholds • 491
- Using SCP Commands • 536
- Using SNMP • 342, 357
- Using the CLI Command • 531, 587
- Using the Command Line Interface • 155, 239, 365, 587, 599
- Using the Reset Button • 586
- Using the Web Interface • 126

V

- Vendor-Specific Attributes • 635, 654
- Viewing Connected Users • 333, 338, 354
- Viewing Firmware Update History • 333, 343

Index

Viewing or Clearing the Local Event Log • 242, 258, 305, 333, 340

Viewing Saved Snapshots and Managing Storage • 295, 350, 352, 355

W

Ways to Probe Existing User Profiles • 688

Web Interface Operations for RCM • 157, 592

Web Interface Overview • 129, 695

Webcam Management • 133, 339, 352

What's New in the PX3 User Guide • xix

Windows NTP Server Synchronization Solution • 270, 271

Wired Network Settings • xx, 24, 27, 218, 219, 232, 246, 624

Wireless LAN Diagnostic Log • 225, 226, 398

Wireless Network Settings • xx, 218, 222, 232

With an Analog Modem • 368

With HyperTerminal • 366, 529

With SSH or Telnet • 367, 694

Writing or Loading a Lua Script • xxi, 327, 331

Y

Yellow- or Red-Highlighted Sensors • 95, 98, 104, 116, 155, 158, 170, 176, 180, 182, 188, 205, 678

Z

Z Coordinate Format • 147, 152

Zero U Connection Ports • xix, 88

Zero U Models' Relocatable Inlet • 86

Zero U Products • 2