



## Raritan PX3 and PX2

Thank you for purchasing the Raritan intelligent power distribution unit (PDU) -- PX3 or PX2.

The intended use of PX2/PX3 is distribution of power to information technology equipment such as computers and communication equipment where such equipment is typically mounted in an equipment rack located in an information technology equipment room.

This Quick Setup Guide explains how to install and configure the PX2/PX3. For further details on using the PX2/PX3, access online help from the application, or download the user guide from Raritan's **Support page** (<http://www.raritan.com/support/>). For more detailed information on this release, see the latest release notes on the Support page.

---

**Note:** In this guide, PX3 refers to PX3 models with "iX7"™ controller. For major differences between PX2 and PX3, see *Appendix C: PX3-Specific Features* (on page 6).

---

### Safety Precautions

**WARNING!** Read and understand all sections in this guide before installing or operating this product. Failure to heed any of the following WARNINGS may result in electric shock, fire, personal injury and death. Prior to operating this product, the user should read the online help and specifically the warnings in the online help.

**WARNING!** Connect this product to an AC power source whose voltage is within the range specified on the product's nameplate.

**WARNING!** Connect this product to an AC power source that is current limited by a suitably rated fuse or circuit breaker in accordance with national and local electrical codes.

**WARNING!** Use this product in a dry location.

**WARNING!** Connect this product to a protective earth ground. Never use a "ground lift adaptor" between the product's plug and the wall receptacle.

**WARNING!** If this product is a model that requires assembly of its line cord or plug, all such assembly must be performed by a licensed electrician and the line cord or plugs used must be suitably rated based on the product's nameplate ratings and national and local electrical codes.

---

### Unpacking the PX2/PX3

PX2/PX3 comes in Zero U, 1U, and 2U sizes. The following describes the equipment shipped with each size.

If any pieces are missing or damaged, report this to Raritan Technical Support, or contact the Raritan partner where you purchased the product.

#### Zero U Size

- PX3 or PX2 PDU
- Mounting screws, brackets and/or buttons
- Cable retention clips for the inlet and/or outlets (for some models only)

#### 1U and 2U Size

- PX3 or PX2 PDU
- 1U or 2U bracket pack and screws
- Cable retention clips for the inlet (for some models only)

---

**Note:** An "optional" null-modem cable with DB9 connectors on both ends (Raritan number: 254-01-0006-00) for PX2 may be available per request. For PX3, use a third party RJ45-to-DB9 adapter/cable instead of a null-modem cable.

---

---

### Before You Begin

1. Prepare the installation site. Make sure the installation area is clean and not exposed to extreme temperatures or humidity. Allow sufficient space around the device for cabling and outlet connections. Safety instructions are provided in the PX2/PX3 online help.
2. Fill out the Equipment Setup Worksheet found in the PX2/PX3 online help. Record the model, serial number, and use of each IT device connected to the PDU's power outlets.

---

### Mounting the PDU

Use one of the mounting methods to install your PX2/PX3 as appropriate.

## Circuit Breaker Orientation Limitation

Usually a PDU can be mounted in any orientation. However, when mounting a PDU with circuit breakers, you must obey these rules:

- Circuit breakers CANNOT face down. For example, do not horizontally mount a Zero U PDU with circuit breakers on the ceiling.
- If a rack is subject to shock in environments such as boats or airplanes, the PDU CANNOT be mounted upside down. If installed upside down, shock stress reduces the trip point by 10%.

---

Note: If normally the line cord is down, upside down means the line cord is up.

---

## Mounting 1U or 2U Models

Using the appropriate brackets and tools, fasten the 1U or 2U device to the rack or cabinet.

### ► To mount the PX2/PX3 device:

1. Attach a rackmount bracket to both sides of the PX2/PX3 with the provided screws.

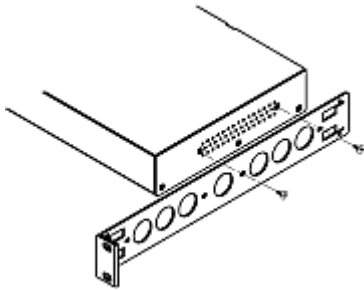

2. Insert the cable-support bar into rackmount brackets.

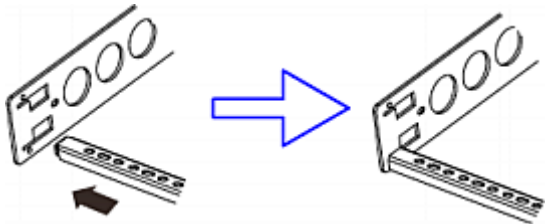

3. Secure with the provided end cap screws.

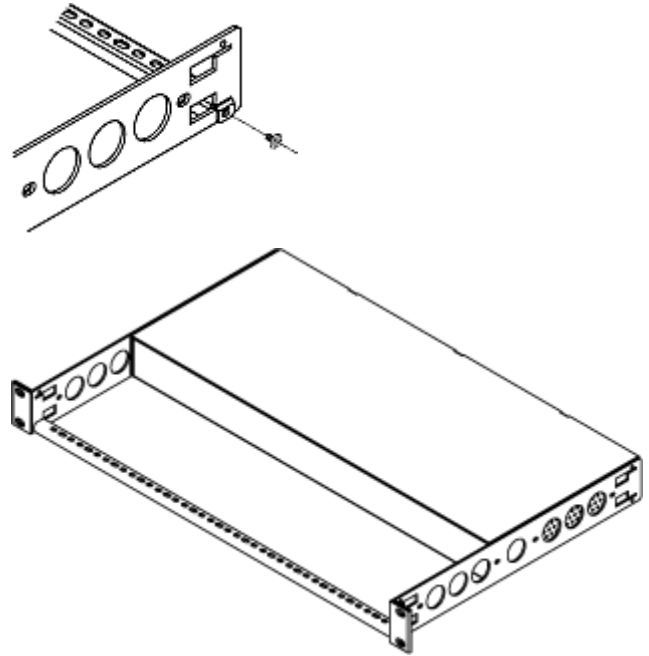

4. Fasten the rackmount brackets' ears to the rack using your own fasteners.

## Mounting Zero U Models Using Baseplate-Based Tools

You can use one of the three baseplate-based tools to mount the PDU: L-brackets, buttons or claw-foot brackets.

### ► To mount Zero U models using baseplates:

1. Align the baseplates on the rear of the PX2/PX3 device.
2. Make the baseplates grasp the device lightly. Use the included L-shaped hex key to loosen the hex socket screws until the baseplate is "slightly" fastened.

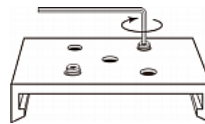

3. Attach brackets or buttons to the baseplates.
  - Fasten each L-bracket or claw-foot bracket to each baseplate with at least three screws (one through each slot).

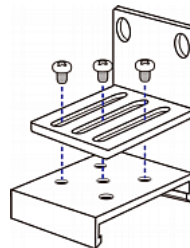

OR

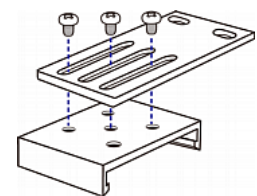

- Screw each mounting button to each baseplate. The recommended torque for the button is 1.96 N·m (20 kgf·cm).

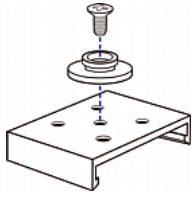

4. Fasten the device to the rack or cabinet using the baseplate-based tools.
  - Use rack screws to fasten L-brackets or claw-foot brackets on the PDU to the rack.
  - For the buttons, press the PDU forward, pushing the mounting buttons through the mounting holes, then letting the device drop about 5/8".

### Mounting Zero U Models Using Buttons

1. Turn to the rear of the PX2/PX3.
2. Locate the two screw holes on the rear panel.
3. Screw a button in each screw hole. The recommended torque for the button is 1.96 N·m (20 kgf·cm).

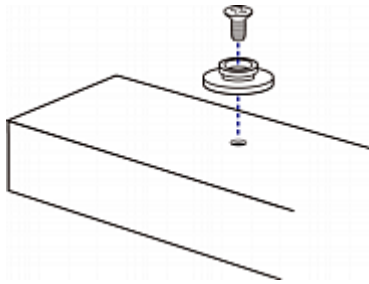

4. Press the PDU forward, pushing the mounting buttons through the mounting holes, then letting the PDU drop slightly.

### Mounting Zero U Models Using L-Brackets and Buttons

1. Fasten the L-bracket to each end of the PDU.

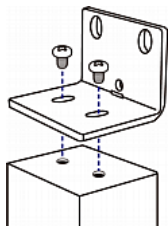

2. Choose either of the following ways to fasten the PDU to the rack.
  - Attach the rack screws to the two rackmount holes of each L-bracket.
  - Screw a mounting button in the back center of each L-bracket and then have both buttons engage the mounting holes in the rack. The recommended torque for the button is 1.96 N·m (20 kgf·cm).

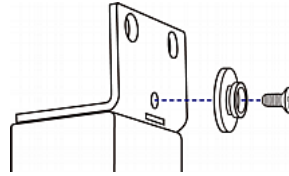

### Installing Cable Retention Clips on the Inlet (Optional)

If your PX2/PX3 device is designed to use a cable retention clip, install the clip before connecting a power cord. A cable retention clip prevents the connected power cord from coming loose or falling off.

#### ► To install and use a cable retention clip on the inlet:

1. Install the cable retention clip by inserting two ends of the clip into the two tiny holes adjacent to the inlet.

#### Zero U models

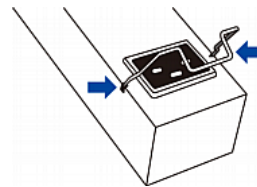

#### 1U/2U models

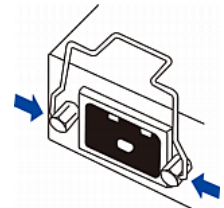

2. Connect the power cord to the inlet, and press the clip to hold the cord.

#### Zero U models

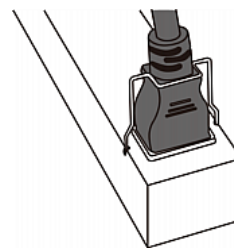

#### 1U/2U models

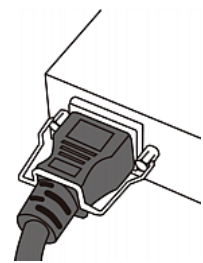

### Connecting the PX3 Locking Line Cord

A PX3 model is shipped with a locking line cord. Plug that cord into the PDU's inlet and the cord is securely locked.

Note: To remove the cord, press the locking clips or push the slide buttons at two sides of the cord's connector. For details, see the topic titled "Disconnecting a PX3 Locking Line Cord" in the PX3 online help.

### Connecting the PDU to a Power Source

The distance between a PDU and its power source must be SHORTER than the PDU's line cord to avoid stretching out the cord. A locking connector used at the power source is highly recommended for a secure connection.

## ► To connect a PDU to the power source:

1. Verify that all circuit breakers on the PX2/PX3 are set to ON. If not, turn them ON.

Or make sure that all fuses are inserted and seated properly. If there are any fuse covers, ensure that they are closed.

---

Note: Not all models have overcurrent protectors.

---

2. Connect each PX2/PX3 to an appropriately rated branch circuit. Refer to the label or nameplate affixed to your PX2/PX3 for appropriate input ratings or range of ratings.
3. When a PX2/PX3 powers up, it proceeds with the power-on self test and software loading for a few moments. At this time, the outlet LEDs cycle through different colors.

---

Note: If a PDU beeps after being powered up, either its circuit breaker has tripped or the L-N wiring is reversed. If no circuit breakers tripped, check the wiring of the plug adapter that is used or the direction in which the plug or plug adapter is plugged into the power socket.

---

4. When the software has completed loading, the outlet LEDs show a steady color and the front panel display illuminates.

---

Note: A PX2-1000 or PX3-1000 PDU does not have outlet LEDs so only the front panel display illuminates.

---

## Connecting the PDU to Your Network

PX2/PX3 can be connected to a wired or wireless network.

### ► To make a wired connection:

1. Connect a standard network patch cable to the Ethernet port on the PX2/PX3.
2. Connect the other end of the cable to your LAN.

---

Note: The "green" Ethernet port labeled "ETH①10/100/1000" supports up to 1000 Mbps so it is highly recommended for network connection. If connecting both ports to the LAN, you must connect them to two "different" subnets. If you are not sure whether the device is connected to the same or different subnets, contact your IT department.

---

### ► To make a wireless connection:

1. Connect an appropriate USB wireless LAN adapter to PX2/PX3.
2. Make sure the wireless LAN configuration is supported by your PX2/PX3. See **Appendix B: Wireless LAN Information** (on page 6).

## Initial Network Configuration

Depending on your networking environment, the best method to initially configure your PX2/PX3 differs.

- For a DHCP IPv4 networking environment, see **Using a Web Browser** (on page 4).
- For an IPv6 or "static" IPv4 networking environment, see **Appendix A: Configuration via a Mobile Device or PDView** (on page 5).

## Using a Web Browser

### Step 1: Retrieve the IP Address

After connecting to a DHCP IPv4 network, an IPv4 address is automatically assigned to your PX2/PX3.

PX3's IP address is available using the front panel display.







PX2's IP address is available by connecting an iOS or Android mobile device to PX2.

### PX3 Models

The PX3 front panel display is similar to the diagram below.



### ► To retrieve the IP address:

1. Press  or  to show the "Main Menu."
2. Press  or  to select "Device Info," and press .
3. Press  or  until the device's IP address is displayed.

### PX2 Models

1. Download Raritan's app, *PDView*, to your mobile device. See **Step 1: Download the "PDView" App** (on page 5).
2. Connect the mobile device to PX2's USB port -- *iOS* via USB-A, or *Android* via USB-B. See **Step 2: Connect the Mobile Device to PX2/PX3** (on page 5).
3. Launch *PDView* to access the PX2 web interface. See **Step 3: Launch PDView** (on page 5).
4. Choose Maintenance > Device Information. Click 'Network' to check the IP address.

---

Alternative: The DHCP-assigned IP address can be also retrieved through the PDU's MAC Address., which is shown on the PDU's label. To use this method, contact your LAN administrator for assistance.

---

### Step 2: Log in to the PX2/PX3 Web Interface

The PX2/PX3 supports common web browsers, including Microsoft Internet Explorer®, Mozilla Firefox®, and Google® Chrome.

### ► To access the PX2/PX3 web interface:

1. In a web browser, enter the PX2/PX3 IP address and login with the default user credentials, accepting any security warnings that may appear.
  - Default login: admin/raritan



Password change is enforced at first login.

## What To Do Next

1. Connect IT equipment to the outlet(s) on the PX2/PX3.
2. Launch the web browser if not yet. See **Step 2: Log in to the PX2/PX3 Web Interface** (on page 4).
3. Choose Device Settings > Date/Time to configure the PX2/PX3 with the proper date and time or synchronize it with an NTP server. The PX2/PX3 device's time must be in sync with the LDAP server to use LDAP authentication.

---

Note: If you are using Sunbird's Power IQ to manage the PX2/PX3, you must configure Power IQ and the PX2/PX3 to have the same date/time or NTP settings.

---

4. To change network settings, choose Device Settings > Network.

---

Tip: You can enable both wired and wireless networking so that the PX2/PX3 can be accessed via either wired or wireless IP address.

---

5. PX2/PX3 is sent from the factory with all the outlets ON. If your model is outlet-switching capable, turn OFF the outlets without devices connected.
6. Use the menu to the left to configure user profiles, privileges, security, or outlet thresholds.

---

Note: Detailed instructions are available in the PX2 or PX3 online help or user guide.

---

## Appendix A: Configuration via a Mobile Device or PDView

An iOS or Android mobile device, such as a smartphone or tablet, can function as a local display of PX2/PX3. Note that the Android device must support USB "On-The-Go" (OTG), or this function does not work.

### Step 1: Download the "PDView" App

Raritan's app "PDView" is required for the mobile device to function as a local display. It is a free app.

#### ► To download PDView:

1. Visit either Apple App or Google Play Store.
  - <https://itunes.apple.com/app/raritan-pdview/id780382738>



- <https://play.google.com/store/apps/details?id=com.raritan.android.pdview>



2. Install PDView.



### Step 2: Connect the Mobile Device to PX2/PX3

The USB cable and USB port to connect are determined by your mobile operating system.

#### ► To connect your mobile device to PX2/PX3:

1. Get an appropriate USB cable for your mobile device.
  - *iOS*: Use the regular USB cable shipped with your iOS mobile device.
  - *Android*: Use an **USB OTG** adapter cable.
2. Connect the mobile device to the appropriate USB port on the PX2/PX3.
  - *iOS*: USB-A port.
  - *Android*: USB-B port

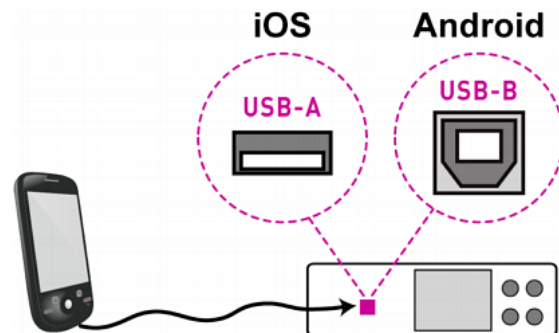

### Step 3: Launch PDView

You can access the PX2/PX3 web interface via PDView to view or change the settings.

#### ► To access the PX2/PX3 web interface:

1. Launch PDView on your mobile device.
2. Wait until PDView detects the connected PX2/PX3 and shows the word "Connected" in green.

**Connected**

3. If the factory-default login credentials remain unchanged, or if PDView has been configured with accurate login credentials, PDView automatically logs in to the web interface of PX2/PX3. If PDView can't login automatically, the login screen displays instead and you must enter appropriate user credentials for login.



4. For initial login, you are prompted to change the password. See **Step 2: Log in to the PX2/PX3 Web Interface** (on page 4).
5. Now you can view the data or change any PX2/PX3 settings.
  - For details, refer to the user guide or online help on the Raritan website.

## Appendix B: Wireless LAN Information

### USB Wireless LAN Adapters

The PX2/PX3 supports the following USB Wi-Fi LAN adapters.

Wi-Fi LAN adapters	Supported 802.11 protocols
SparkLAN WUBR-508N	A/B/G/N
Proxim Orinoco 8494	A/B/G
Zyxel NWD271N	B/G
Edimax EW-7722UnD	A/B/G/N
TP-Link TL-WDN3200 v1	A/B/G/N
Raritan USB WIFI	A/B/G/N

### Connecting the Wireless LAN Adapter

You can connect the wireless LAN adapter either to PX2/PX3 or to a USB hub attached to PX2/PX3.

#### ► To make a wireless connection:

Do one of the following:

- Plug a supported USB wireless LAN adapter into the USB-A port on your PX2/PX3.
- Connect a USB hub to the USB-A port on the PX2/PX3. Then plug the supported USB wireless LAN adapter into the appropriate USB port on the hub.

### Supported Wireless LAN Configuration

If wireless networking is preferred, ensure that the wireless LAN configuration of your PX2/PX3 matches the access point. The following is the wireless LAN configuration that the PX2/PX3 supports.

- Network type: 802.11 A/B/G/N
- Protocol: WPA2 (RSN)
- Key management: WPA-PSK, or WPA-EAP with PEAP and MSCHAPv2 authentication
- Encryption: CCMP (AES)

**Tip: Supported 802.11 network protocols vary according to the wireless LAN adapter being used with the PX2/PX3. See *USB Wireless LAN Adapters* (on page 6).**

**Note: You must configure PX2/PX3 to enable its wireless LAN interface. See the topic titled *Configuring Network Settings in the User Guide*.**

## Appendix C: PX3-Specific Features

### Dual Networking and Power Sharing

PX3 with iX7™ controller supports the following significant features.

- **Dual networking with two Ethernet ports (ETH1/ETH2):**  
Both Ethernet ports must connect to two "different" subnets. Connection to the same subnet is NOT recommended.
- **Power sharing via the EXPANSION port:**  
Power sharing ensures the continuous accessibility to the PX3 controller when a power failure occurs on its inlet.

For more information on dual Ethernet and power sharing functionality, refer to PX3 online help or user guide. Port locations on your PX3 may look different from the following illustration.

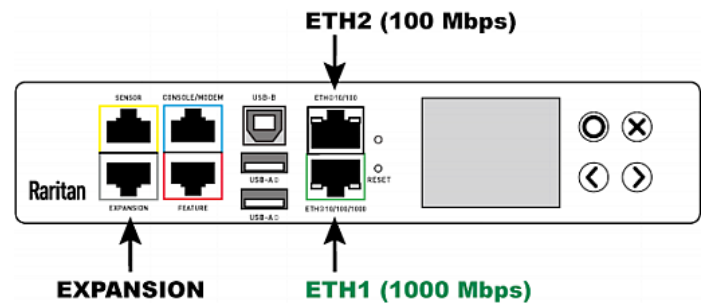

### PX3 Replaceable Controller

PX3 Zero U model has a 'replaceable' controller. You can replace the controller if it is broken. Contact Raritan Technical Support when a replacement controller is needed.

For detailed information on how to remove it, refer to the topic titled "Replaceable Controller" in the PX3 online help.

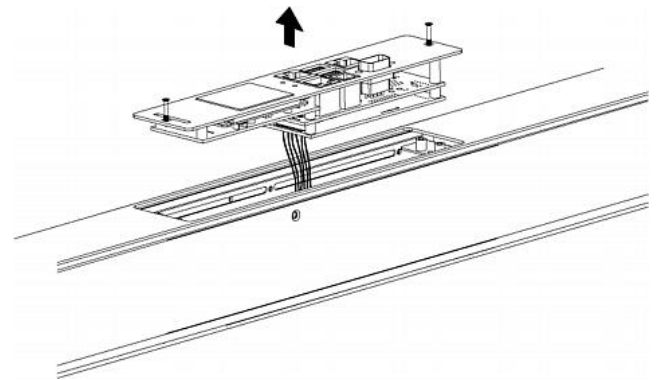

## Appendix D: More Information

### Identifying the Sensor Port

Warning: If you purchase Raritan's environmental sensor packages, make sure you connect them to the correct port on the PX2/PX3, or damages may be caused to PX2/PX3 and/or connected sensor packages.

► **How to identify the SENSOR port:**

- The correct port is labeled SENSOR.
- The SENSOR port is marked with YELLOW color on a PX3 PDU, as shown below.



Note: On a PX2 PDU, there is no yellow color shown on the SENSOR port.

### Threaded Grounding Point

If the PX2/PX3 model you purchased is designed to have a threaded grounding point, you can identify it via the grounding symbol as shown below:



Wire this point to an electrical system in order to protectively ground the PX2/PX3.

### Additional Information

For more information about PX2/PX3 and the entire Raritan product line, see Raritan's website ([www.raritan.com](http://www.raritan.com)). For technical issues, contact Raritan Technical Support. See the Contact Support page in the Support section on Raritan's website for technical support contact information worldwide.

Raritan's products use code licensed under the GPL and LGPL. You can request a copy of the open source code. For details, see the Open Source Software Statement at (<http://www.raritan.com/about/legal-statements/open-source-software-statement/>) on Raritan's website.