

Raritan AMS Series Intelligent Electronic Asset Management

Thank you for purchasing Raritan AMS asset management strips (asset strips), which work with Raritan's Smart Rack Controller (SRC), EMX, PX2, PX3, PX3TS transfer switches or BCM1/PMC models for providing the asset management solution. This asset management solution helps you track the locations of tens or hundreds of IT devices in the data center and server room.

Note: Refer to the table below for a list of Raritan products which support this solution.

This Quick Setup Guide explains how to install and configure asset strips. For additional information on the asset management operation, refer to Raritan Online Help for SRC, EMX, PX2, PX3, PX3TS or BCM, which is available from the **Support page** [<http://www.raritan.com/support/>] or the **Product Online Help page** [<http://www.raritan.com/support/online-help/>] on the Raritan website.

An Overview of the Asset Management Solution

The asset management solution involves using diverse Raritan asset management devices and a third-party asset management software.

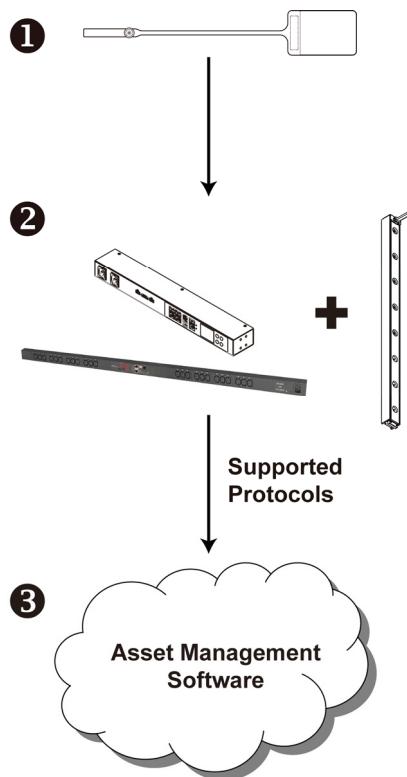

Number	Description
2	Raritan Asset Management Gateway where the asset strips are physically connected, such as Raritan SRC or PX3.
3	The third-party asset management software, such as a common web browser or Sunbird's dcTrack.

A third-party asset management software can access Raritan asset strips through a Raritan Asset Management Gateway via Raritan-supported protocols, such as SNMP, JSON-RPC, HTTPS or command line interface.

The following table lists Raritan devices and firmware versions that function as the asset management gateway.

Raritan products	Firmware versions
Smart Rack Controller	Version 3.5.10 or later
EMX rack management devices	All versions
PX2 power distribution units (PDUs)	Version 2.2.0 or later
PX3 PDUs	Version 2.5.20 or later
PX3TS transfer switches	Version 2.6.0 or later
BCM1 and PMC	All versions

Warning: Though PMC models (belonging to the BCM2 product family) support asset management, other "BCM2-based" models do NOT support this feature.

The Configuration Management Database (CMDB) where asset IDs are associated with assets is stored in a network drive. You can use an asset management software to access this database.

Number	Description
1	Raritan asset management tags (AMT), each of which has a unique asset ID (that is, the barcode).

Combining Regular Asset Strips

Each tag port on the regular asset strips corresponds to a rack unit and can be used to locate IT devices in a specific rack (or cabinet).

For each rack, you can attach asset strips up to 64U long, consisting of one MASTER and multiple SLAVE asset strips.

The difference between the master and slave asset strips is that the master asset strip has an RJ-45 connector while the slave does not.

The following diagram illustrates some asset strips. Note that Raritan provides more types of asset strips than the diagram.

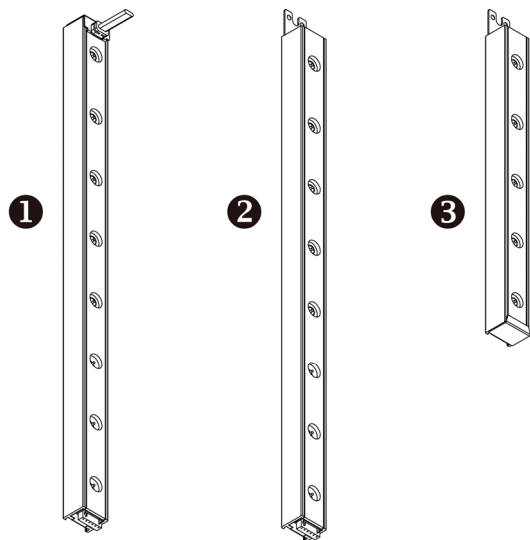

❶	8U MASTER asset strip with 8 tag ports
❷	8U SLAVE asset strip with 8 tag ports
❸	5U "ending" SLAVE asset strip with 5 tag ports

Note: Unlike general slave asset strips, which have one DIN connector respectively on either end, the ending slave asset strip has one DIN connector on only one end. An ending asset strip is installed at the end of the asset strip assembly.

► To assemble asset strips:

1. Connect a MASTER asset strip to an 8U SLAVE asset strip.
 - Plug the white male DIN connector of the slave strip into the white female DIN connector of the master strip.

- Make sure that the U-shaped sheet metal adjacent to the male DIN connector is inserted into the rear slot of the master strip. Screw up the U-shaped sheet metal to reinforce the connection.

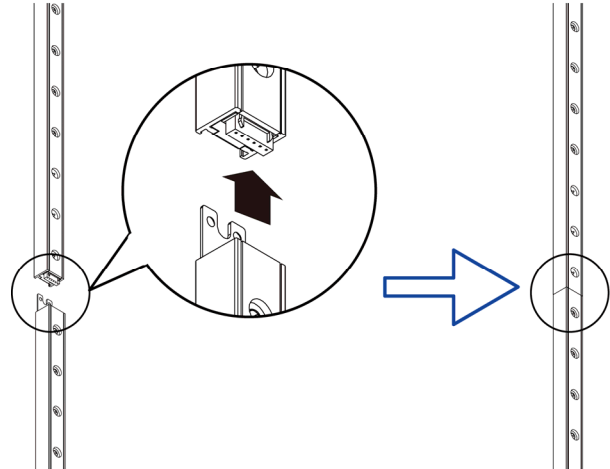

2. Connect another 8U slave strip to the one being attached to the master strip in the same manner as Step 1.
3. Repeat the above step to connect more slave strips. The length of the asset strip assembly can be up to 64U.
 - The final slave strip can be 8U or 5U, depending on the actual height of your rack.
 - Connect the "ending" asset strip as the final one in the assembly.
4. Vertically attach the asset strip assembly to the rack, next to the IT equipment, making each tag port horizontally align with a rack unit.
5. The asset strips are automatically attracted to the rack because of magnetic stripes on the back.

Note: The asset strip is implemented with a tilt sensor so it can be mounted upside down.

Connecting Regular Asset Strips to Raritan Asset Management Gateway

Raritan SRC, EMX, PX2, PX3, PX3TS and BCM1/PMC devices function as a Raritan Asset Management Gateway after having asset strips connected. See *An Overview of the Asset Management Solution* (on page 1) for a list of Raritan devices.

Important: You must use Raritan's X adapter cable to connect asset strips to EMX2-111, PX2 PDUs and BCM1 (NOT BCM2). Otherwise, EMX2-111, PX2 or BCM1 cannot detect the connected asset strips. For the X cable connection method, see *X Cable Connection* (on page 3).

You need both asset strips and asset tags for tracking IT devices.

Asset tags provide an ID number for each IT device. The asset tags are adhered to an IT device at one end and plugged in to an asset strip at the other.

The asset strip is connected to the Raritan Asset Management Gateway, and the asset tag transmits the ID and positioning information to the asset strip.

The following diagram illustrates an asset tag. Note that there are two types of asset tags: non-programmable and programmable tags. The only difference is that programmable asset tags allow you to customize each tag's ID or barcode number while non-programmable ones have factory default ID or barcode numbers, which you cannot change.

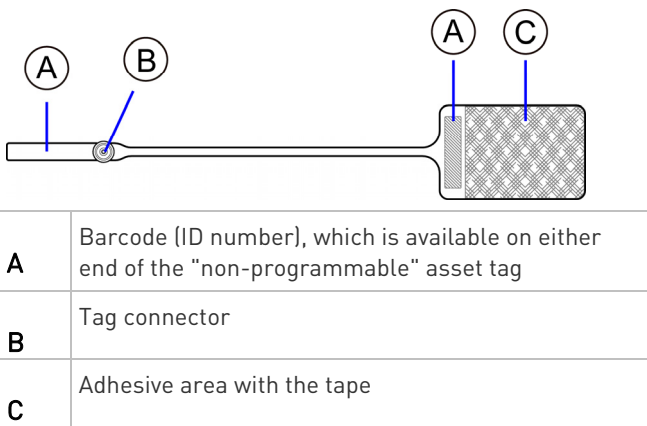

Note: The barcode of each "non-programmable" asset tag is unique and is displayed in the Raritan Asset Management Gateway device's web interface for identification.

► **To connect regular asset strips to the Raritan Asset Management Gateway device:**

1. Affix the adhesive end of an asset tag to each IT device through the tag's tape.
2. Plug the connector of each asset tag into the corresponding tag port on the asset strip.
3. Connect the asset strip assembly to the Raritan Asset Management Gateway device, using a network patch cable (CAT5e or higher).
 - a. Connect one end of the cable to the RJ-45 connector on the MASTER asset strip.
 - b. Connect the other end of the cable to the FEATURE port on the Raritan Asset Management Gateway device.

The Raritan Asset Management Gateway device supplies power to the connected asset strip assembly. All LEDs on the asset strip assembly may cycle through different colors during the power-on process if the asset strip's firmware is being upgraded by the Raritan Asset Management Gateway. After the power-on or firmware upgrade process completes, the LEDs show solid colors. Note that the LED color of the tag ports with asset tags

connected will be different from the LED color of the tag ports without asset tags connected.

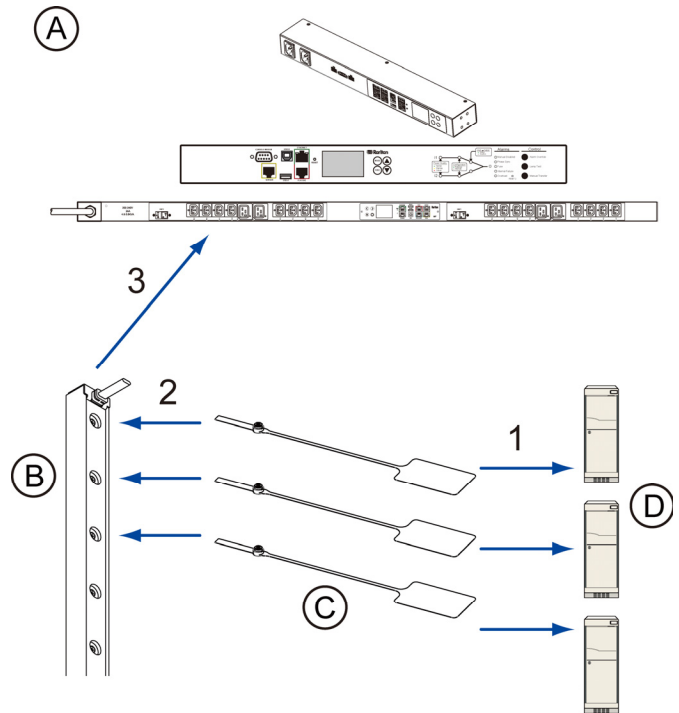

Letter	Item
A	Raritan Asset Management Gateway device: Raritan SRC, EMX, PX2, PX3, PX3TS or BCM1/PMC
B	Asset strips
C	Asset tags
D	IT equipment, such as servers

Note: The supported maximum cabling length differs depending on the Raritan Asset Management Gateway device you purchased. Refer to the User Guide or Online Help for your Raritan Asset Management Gateway device.

4. If the Raritan Asset Management Gateway device has more than one FEATURE port, repeat the above steps to connect additional asset strips to the rest of FEATURE ports.

X Cable Connection

A Raritan X cable is required for asset strip connections on EMX2-111, PX2 PDUs or BCM1 products. This section briefly explains how to connect asset strips with an X cable. For detailed information on X cables, refer to the the EMX or PX2 user documentation.

Note: Other Raritan products do not need the X cable, including SRC, EMX2-888, PX3 PDUs, PX3TS transfer switches, and PMC power meters.

► **To use an X cable to connect asset strips:**

1. Plug the male RJ-12 phone connector at the shorter end of the X cable into the RJ-12 SENSOR port on the Raritan Asset Management Gateway device.
2. Plug the male RJ-45 connector at the shorter end of the X cable into the FEATURE port on the Raritan Asset Management Gateway device.
3. Connect the asset strip's RJ-45 connector to the male RJ-45 connector at the longer end of the Raritan X cable.

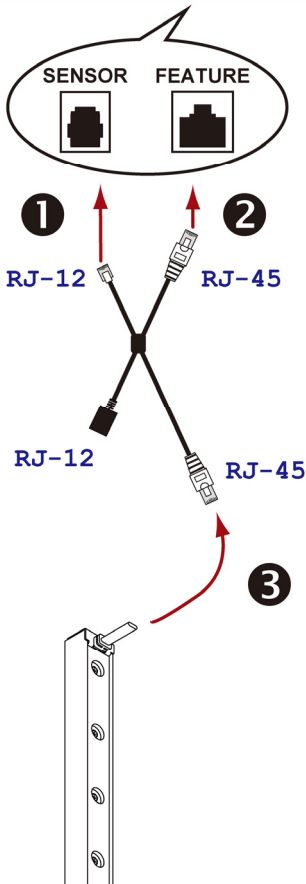
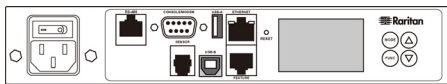

Connecting Composite Asset Strips (AMS-Mx-Z)

A composite asset strip is named AMS-Mx-Z, where x is a number, such as AMS-M2-Z or AMS-M3-Z. It is a type of asset strip that functions the same as regular MASTER asset strips except for the following differences:

- It has two RJ-45 connectors.
- Multiple composite asset strips can be daisy chained.

- It contains less tag ports than regular asset strips.
For example, AMS-M2-Z contains two tag ports, and AMS-M3-Z contains three tag ports only.

The composite asset strip is especially useful for tracking large devices such as SAN boxes in the cabinet.

The following diagram illustrates AMS-M3-Z.

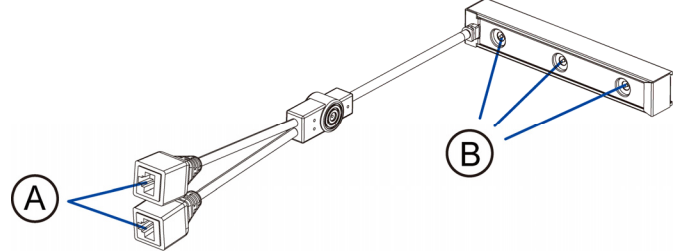

A	Two RJ-45 connectors
B	Tag ports

Important: DO NOT hot swap or hot plug any AMS-Mx-Z in a composite asset strip chain after connecting the chain to the Raritan Asset Management Gateway device. Doing so may cause the device's FEATURE port to malfunction.

► **To connect composite asset strips to the Raritan Asset Management Gateway device:**

If there are only 2 or 3 IT devices to track, you can connect only one AMS-M2-Z or AMS-M3-Z to the Raritan Asset Management Gateway device. In this case, go to step 2. If there are more than 2 or 3 IT devices, you need to daisy chain multiple composite asset strips and start from step 1.

1. (Optional) Daisy chain multiple composite asset strips.
 - a. Get a standard network patch cable that is within 2 meters.
 - b. Connect one end of the network cable to the RJ-45 connector labeled "Output" on the first composite asset strip.
 - c. Connect the other end of the cable to the RJ-45 connector labeled "Input" on the secondary composite asset strip.
 - d. Repeat the same steps to connect more composite asset strips. See *Daisy-Chain Limitations of Composite Asset Strips* (on page 5) for the maximum number of composite asset strips supported per chain.

Note: Different types of composite asset strips can be mixed in a chain.

2. Connect the composite asset strip(s) to the Raritan Asset Management Gateway device via a standard network patch cable (CAT5e or higher).
 - a. Connect one end of the cable to the RJ-45 port labeled "Input" on the composite asset strip.

- For a composite asset strip chain, connect the cable to the "Input" port of the first asset strip.
- b. Connect the other end of the cable to the FEATURE port on the Raritan Asset Management Gateway device.
3. Affix an asset tag to the IT device. Then connect this asset tag to the composite asset strip by plugging the tag connector into the tag port on the composite asset strip. For details, see **Connecting Regular Asset Strips to Raritan Asset Management Gateway** (on page 2).
 4. (Optional) For a chain, it is highly recommended using the cable ties to help hold the weight of all connecting cables.

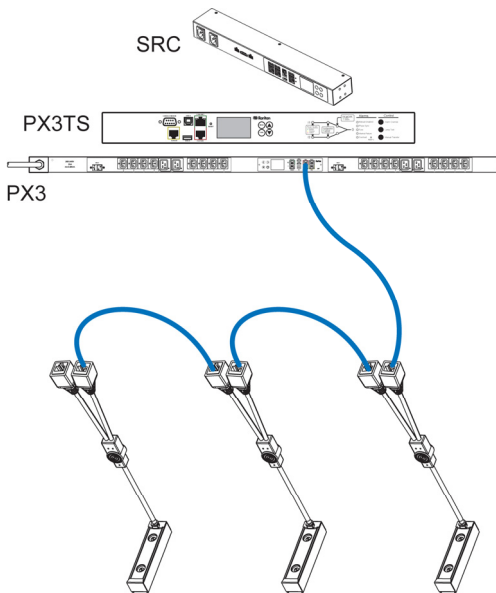

5. Repeat Step 3 to connect IT devices to the other composite asset strips in the chain.

Daisy-Chain Limitations of Composite Asset Strips

There are some limitations when daisy chaining composite asset strips "AMS-Mx-Z," where x is a number.

- The maximum cable length between composite asset strips is 2 meters, but the total cable length cannot exceed 10 meters.
- The maximum number of composite asset strips that can be daisy chained depends on the Raritan product you purchased.
- It is NOT supported to hot swap or hot plug any AMS-Mx-Z in a composite asset strip chain that has been connected to Raritan's PDU, SRC, or PMC. Therefore, first disconnect the chain from the device when you need to swap or add any AMS-Mx-Z to the chain.

Raritan devices	Maximum strips per chain
PX2 PDUs, BCM1 (NOT BCM2 series)	
Smart Rack Controller, EMX2-888, PX3 PDUs, PX3TS transfer switches PMC (BCM2 series)	Up to 6 composite asset strips are supported.

Tip: To increase the maximum number of composite asset strips attached to a Raritan PX2 PDU, EMX2-111 or BCM1, use Raritan's X cable to enhance the power supply to the asset strip chain. Refer to PX2 or EMX user documentation for information on the X cable.

Connecting Blade Extension Strips

For blade servers, which are contained in a single chassis, you can use a blade extension strip to track individual blade servers.

Raritan's blade extension strip functions similar to a Raritan asset strip but requires a tag connector cable for connecting it to a tag port on the regular or composite asset strip. A blade extension strip contains 4 to 16 tag ports.

The following diagrams illustrate a tag connector cable and a blade extension strip with 16 tag ports.

Tag connector cable

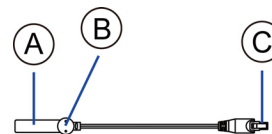

A	Barcode (ID number) for the tag connector cable
B	Tag connector
C	Cable connector for connecting the blade extension strip

Note: A tag connector cable has a unique barcode, which is displayed in the Raritan Asset Management Gateway device's web interface for identifying each blade extension strip where it is connected.

Raritan devices	Maximum strips per chain
EMX2-111,	Up to 4 composite asset strips are supported.

Blade extension strip with 16 tag ports

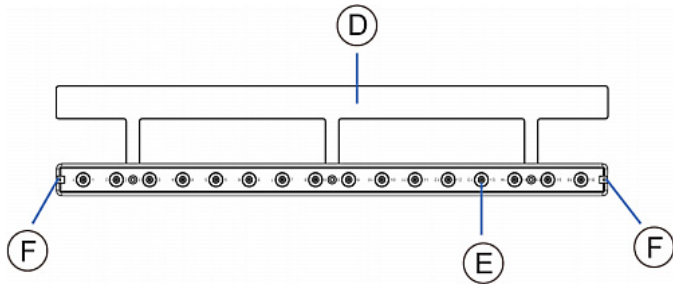

D	Mylar section with the adhesive tape
E	Tag ports
F	Cable socket(s) for connecting the tag connector cable

Note: Each tag port on the blade extension strip is labeled a number, which is displayed as the slot number in the Raritan Asset Management Gateway device's web interface.

► To install a blade extension strip:

1. Connect the tag connector cable to the blade extension strip.
 - Plug the cable's connector into the socket at either end of the blade extension strip.

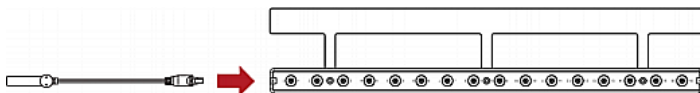

2. Move the blade extension strip toward the bottom of the blade chassis until its mylar section is fully under the chassis, and verify that the blade extension strip does not fall off easily. If necessary, you may use the adhesive tape in the back of the mylar section to help fix the strip in place.

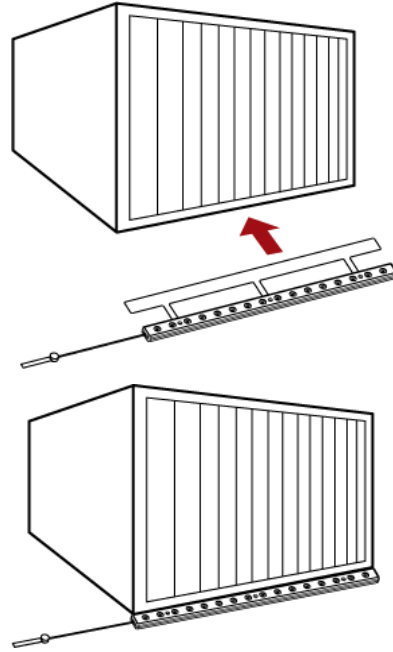

3. Connect one end of an asset tag to a blade server and the other end to the blade extension strip.
 - a. Affix the adhesive part of the asset tag to one side of a blade server through the tag's tape.
 - b. Plug the tag connector of the asset tag into a tag port on the blade extension strip.

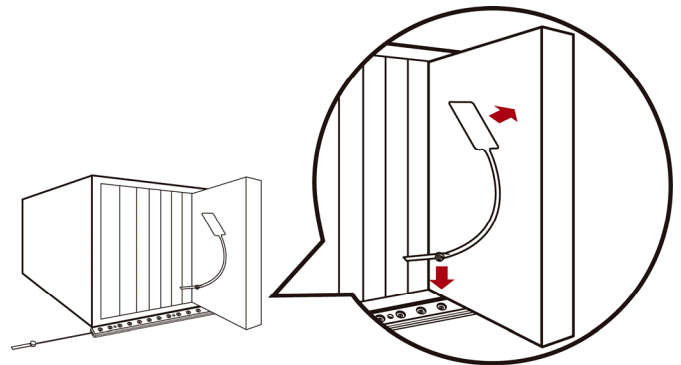

4. Repeat the above step until all blade servers in the chassis are connected to the blade extension strip via asset tags.

5. Plug the tag connector of the blade extension strip into the closest tag port of the regular or composite asset strip on the rack.

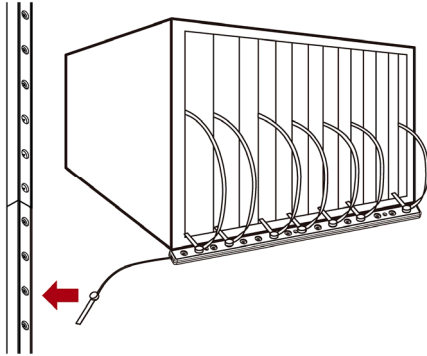

6. Repeat the above steps to connect additional blade extension strips. Up to 128 asset tags on blade extension strips are supported per FEATURE port.

Note: If you need to temporarily disconnect the blade extension strip from the asset strip, wait at least 1 second before re-connecting it back, or the Raritan Asset Management Gateway device may not detect it.

What to Do Next

1. Open a web browser and type the IP address of Raritan Asset Management Gateway.
 2. When prompted for a user name and password, enter *admin* and the new password you assigned during the initial configuration of the Raritan Asset Management Gateway device. Refer to the Quick Setup Guide accompanying your Raritan Asset Management Gateway device.
- Note: The factory default password for the admin user is raritan.
3. The Raritan Asset Management Gateway home page displays.
 4. Configure each asset strip assembly in the web interface.
 - a. Click 'Asset Strip' or 'Feature Ports' in the left menu, which displays the asset strip data.

Note: Only EMX2-888 shows the name 'Feature Ports' after it detects the connection of asset strips because it has more than one FEATURE ports.

- b. Click Edit Settings in the right pane after the selected asset strip's data page opens. The setup dialog appears.
 - c. Provide necessary information, including the desired name for the asset strip, LED colors, numbering and so on.
5. By default all LEDs on the asset strips are set to the Auto mode. Each LED's color on the asset strip changes

according to whether an asset tag is detected. You can make a specific LED's behavior or color different.

- a. Click the desired rack unit (tag port) in the rack unit list.
- b. The setup dialog for the selected rack unit appears. Now you can change its settings, including the LED mode and colors.

Note: Detailed instructions are available in the User Guide or Online Help for your Raritan Asset Management Gateway device.

Additional Information

For more information about Raritan Asset Management Gateway and the entire Raritan product line, see Raritan's website (www.raritan.com). For technical issues, contact Raritan Technical Support. See the Contact Support page in the Support section on Raritan's website for technical support contact information worldwide.

Raritan's products use code licensed under the GPL and LGPL. You can request a copy of the open source code. For details, see the Open Source Software Statement at (<http://www.raritan.com/about/legal-statements/open-source-software-statement/>) on Raritan's website.

Safety Certifications

The following lists the certifications Raritan has obtained for AMS series products except for composite asset sensors (AMS-Mx-Z).

FCC

This device complies with Part 15 Class A of the FCC Rules. Operation is subject to the following two conditions:

1. This device may not cause harmful interference, and
2. This device must accept interference received, including interference that may cause undesired operation.

VCCI

この装置は、クラスA情報技術装置です。この装置を家庭環境で使用すると電波妨害を引き起こすことがあります。この場合には使用者が適切な対策を講ずるよう要求されることがあります。 VCCI-A

Canadian ICES-003

CAN ICES-3 (A) / NMB-3 (A)